

INSTRUCTION MANUAL

Model: A02



Please scan the code to watch the installation video
After-sales Support: info@i-plus.com

Attention:

Thank you very much for your purchase.

When the number of your order is more than 1, we will split your order and ship the goods separately to ensure the safety.

We promise to deliver at the same time, but the time of receipt may be slightly different due to logistics.

Each tracking number corresponds to only one cargo, you can contact info@i-plus.com for more logistics information. Thanks again for your understanding.

PARTS LIST

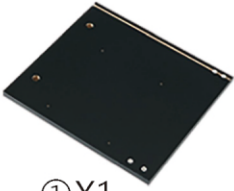

① X1

Left side panel
14.4*13.1*0.6in



② X1

Right side panel
14.4*13.1*0.6in



③ X1

Left trim panel
13.1*1.96*0.6in



④ X1

Right trim panel
13.1*1.96*0.6in



⑤ X1

Rear trim panel
18.03*1.96*0.6in



⑥ X1

Main panel
19.3*13.1*0.6in



⑦ X1

Front trim panel
19.3*2.56*0.6in



⑧ X2

Support panel-1
7.1*4.92*0.6in



⑨ X2

Support panel-2
13*4.92*0.6in



⑩ X1

Fixed panel
19.3*13.1*0.6in



⑪ X1

Front skirting panel
18.03*3.15*0.6in



⑫ X1

Rear skirting panel
18.03*2.36*0.6in

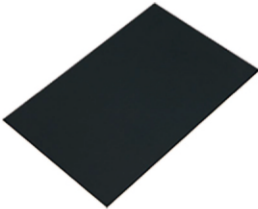

⑬ X1

Back panel
18.43*12.44*0.16in



⑭ X2

Drawer left
9.85*3.15*0.6in



⑮ X2

Drawer right
9.85*3.15*0.6in



⑯ X2

Drawer back
15.83*3.15*0.6in



⑰ X2

Drawer bottom
16.22*9.6*0.16in



⑱ X2

Drawer front
19.05*5.9*0.6in

HARDWARE LIST



A 51+2 set

Cam Bolt & Cam Lock
F7*31 F15*11



B 15+2 set

Wood Dowel
F8*30



6+1 pcs 1+1 pcs

C 1 set (8 pcs)

Screw & Allen Key
F5*40



D 2 set (8 pcs)

Slide rail
F20*250



E 16+2 pcs

Screw
F3.5*14



F 6+1 set

Rear panel hook & screw
F3*14



G 51+1 pcs

Hole cover
F20



H 1 pcs

Screw driver

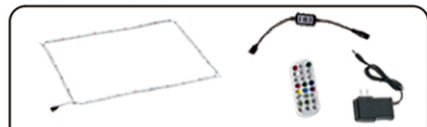

I 1 set

Light strip



Spare 5 pcs

Insert nut
F10*11
If the nut is missing from the panel,
use a hammer to drive in the spare nut.



Attention:

1. Please place the product on the carpet or carton to assemble to avoid scratching the floor;
2. During the installation process, keep away from children and pets, and avoid accidentally swallowing spare parts;
3. It is recommended to use a low-speed electric drill for installation.

INSTRUCTION MANUAL

Step 1

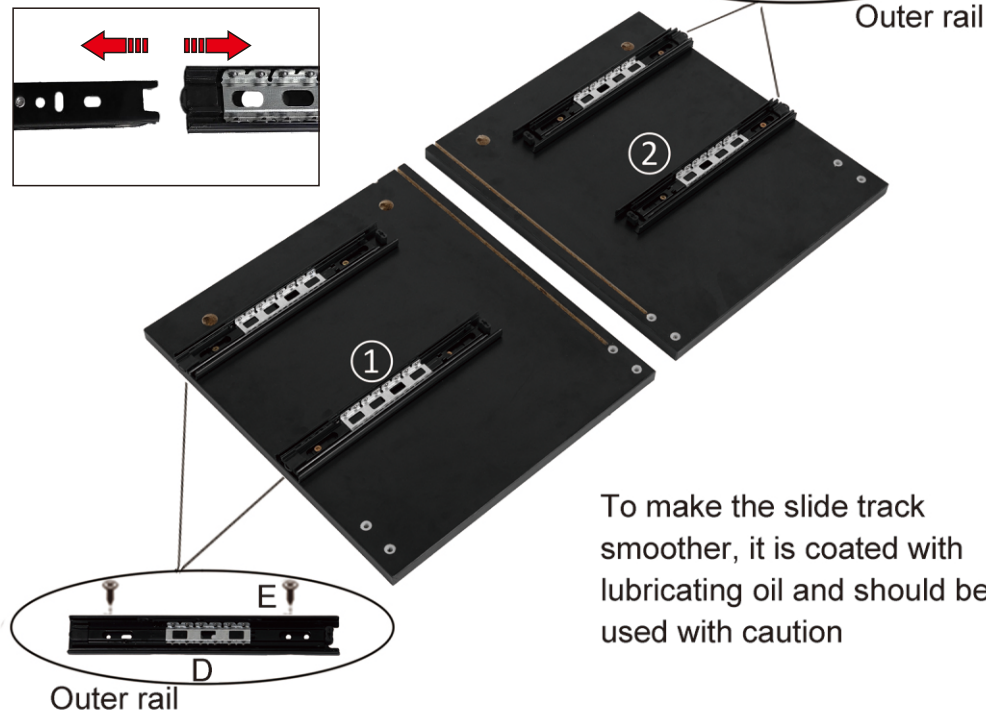
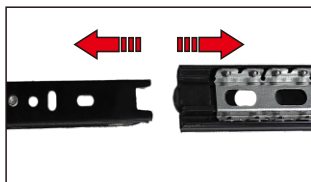
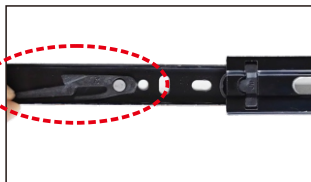

To make the slide track smoother, it is coated with lubricating oil and should be used with caution

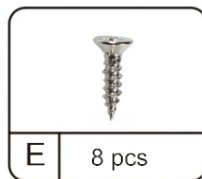
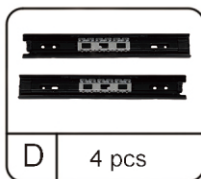

INSTRUCTION MANUAL

Step 2

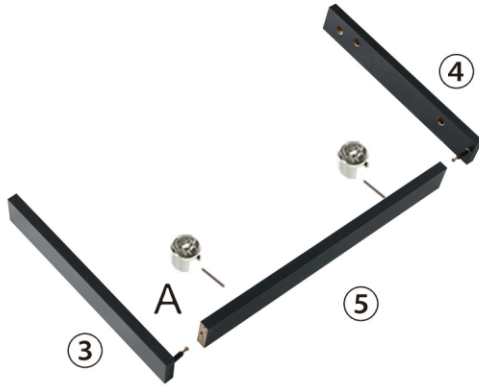

(Attention: Cam bolt & Insert nut need to be put together)

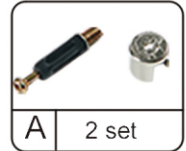

Step 3

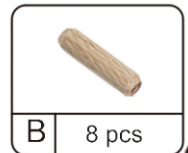
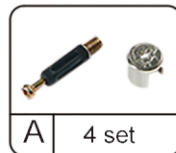
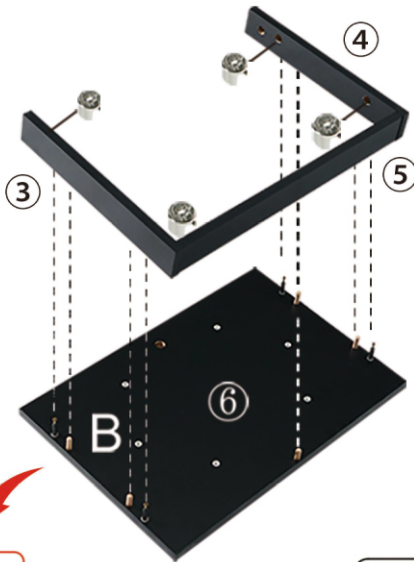

INSTRUCTION MANUAL

Step 4

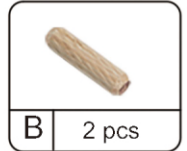
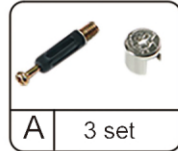
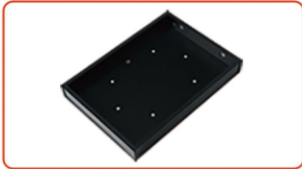
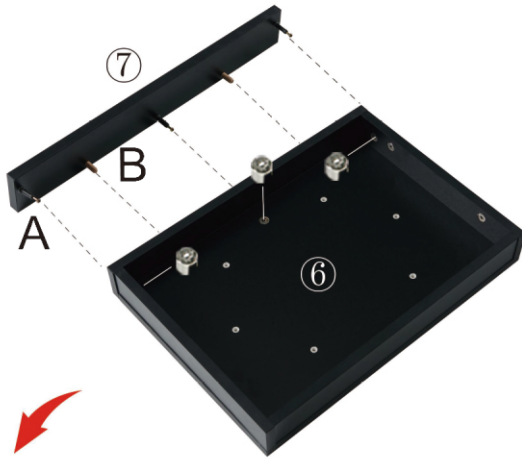

Step 5

Note: the direction of ⑧, ⑨

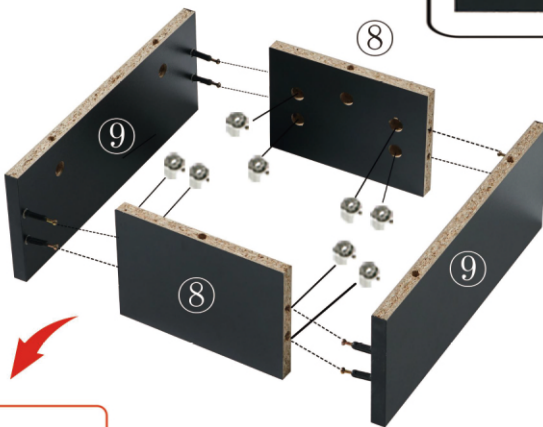

INSTRUCTION MANUAL

Step 6

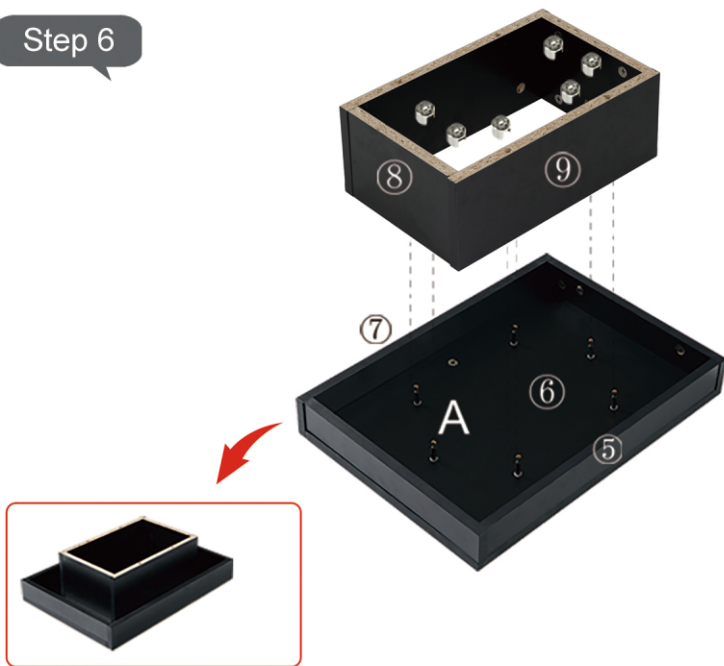

Step 7

Stick light strip to the ⑥

Note1: The direction of the light strip.

Note2: After the Light strip is pasted incorrectly, it should be gently removed to prevent damage.

Note3: When the light strips are connected to each other, the plus sign "+" must correspond, please ignore the letter "RGB".

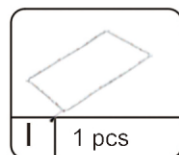
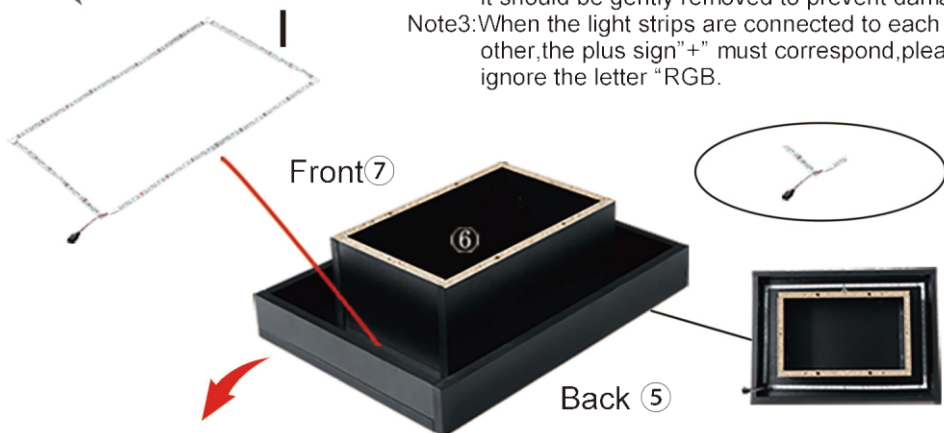

INSTRUCTION MANUAL

Step 8

Use the Allen key from the parts kit to screw the screws into the plate in a clockwise direction.

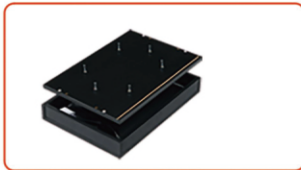
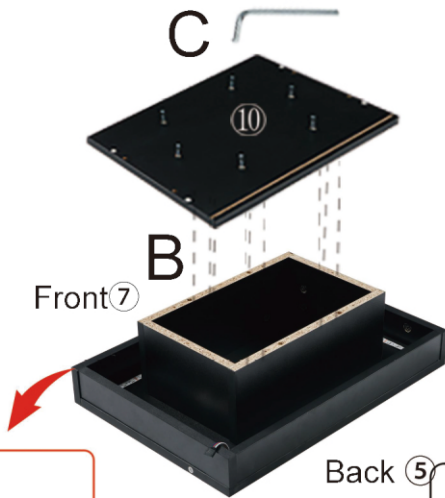

Back ⑤

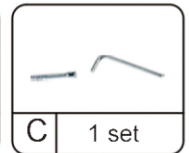
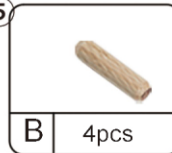

Step 9

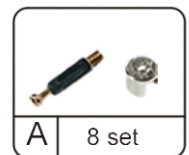
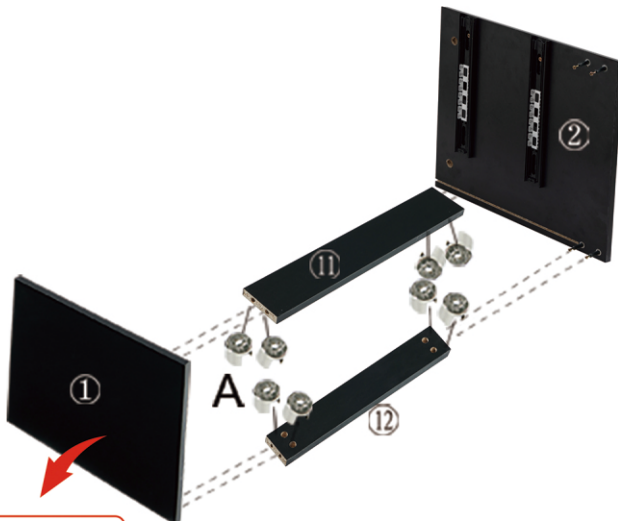

INSTRUCTION MANUAL

Step 10



Step 11

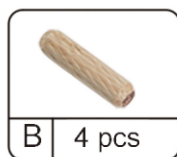
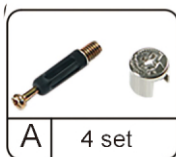

INSTRUCTION MANUAL

Step 12 X2

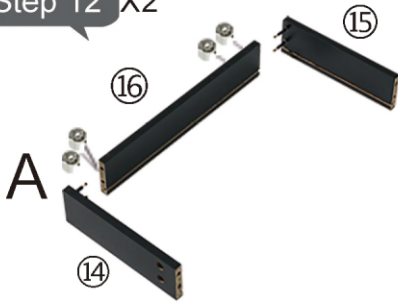

1. Connect part 14&15 to 16



2. Insert part 17

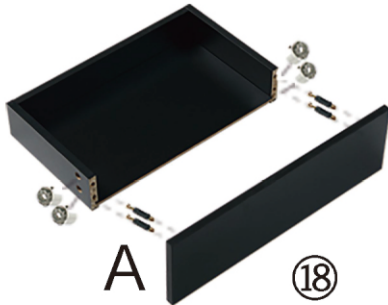

3. Connect part 18



4. Install hardware "D" to part 14 & 15 according to the pre-drilled holes

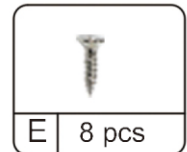
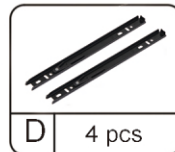
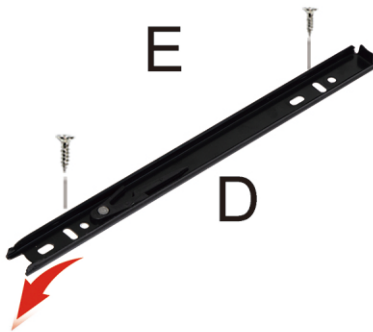

INSTRUCTION MANUAL

Step 13

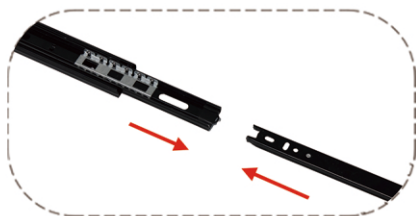

Step 14



As the picture shows, fix hardware "F" into the gap with screws to make the back panel more stable.

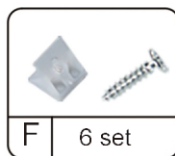

Step 15

Attention:

- The plastic cover prevents the light strip interface from falling off from the controller.
- You can operate the advanced remote control in any direction to switch mode or light.

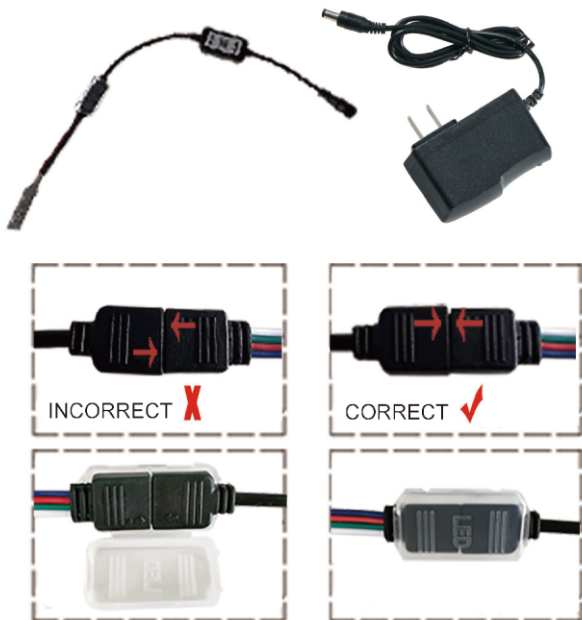

1. If the plastic cover falls off, connect the light strip plug to the adapter socket correctly



2. Take out the remote control gasket

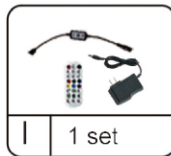

1 set

Step 16

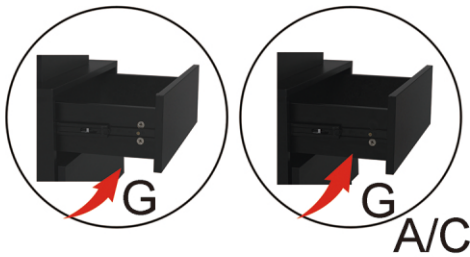
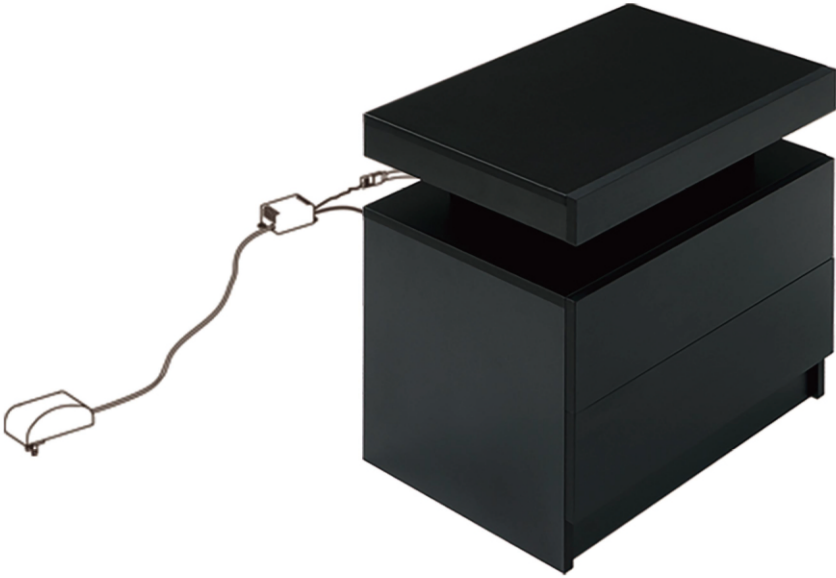

Please stick the hardware "G" on the exposed cam lock hole that makes your product more beautiful.

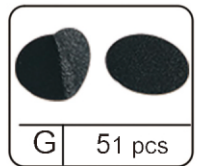



Congratulations on successful installation!!!