



DREO | Humidifier HM512S

USER MANUAL

www.dreo.com

Looking for help?

Contact us to get expert support.

 support@dreo.com  (888) 290-1688  www.dreo.com

Mon - Fri, 9:00 am-5:00 pm PST/PDT

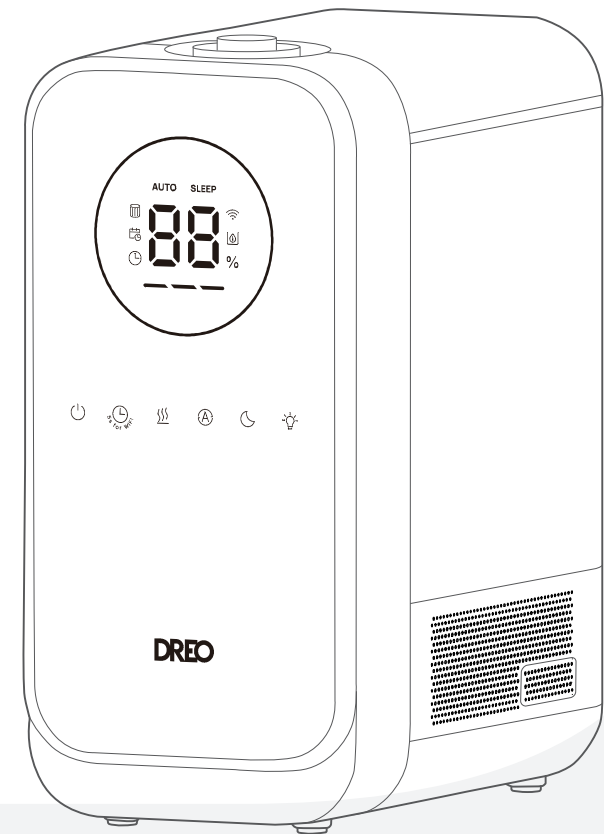

”

Thanks for Choosing DREO!

Your support means the world to us.
We hope you enjoy our product as much
as we did creating it.

CONTENTS

01

IMPORTANT SAFETY
INSTRUCTIONS

1

02

KNOWING YOUR
HUMIDIFIER

3

03

CONNECTING TO YOUR
HUMIDIFIER

7

04

USING YOUR
HUMIDIFIER

8

05

CLEANING AND
MAINTENANCE

12

06

TROUBLESHOOTING

18

07

DREO CUSTOMER
CARE

20

IMPORTANT SAFETY INSTRUCTIONS

01

READ AND SAVE THESE INSTRUCTIONS



DANGER

READ ALL CAUTIONARY MARKINGS ON THE APPLIANCE AND SAFETY INSTRUCTIONS IN THE USER MANUAL BEFORE USE.



DO NOT

touch or hold the mains plug with wet hands.



DO NOT

block or cover the nozzle while in operation.



DO NOT

let children or pets play with this appliance.

General Safety

1. Children shall not play with the appliance. Cleaning and maintenance shall not be performed by children without supervision.
2. Use the appliance as described in the user manual only. Any other use not recommended in the user manual may cause fire, electrical shock, or personal injury.
3. This appliance can be used by children aged above 8 years and persons with reduced physical, sensory or mental capabilities or lack of experience and knowledge if they have been given supervision or instruction concerning use of this appliance in a safe way and understand the hazards involved.

Operation Safety

1. Always place this appliance on a firm, flat and level surface to avoid dropping or tilt.
2. Always place this appliance 2 feet (60 cm) above the floor, 12 inches (30 cm) away from the wall or wooden furniture.
3. DO NOT move this appliance while it is on.
4. DO NOT attempt to repair any parts on this appliance. Doing so will void your warranty. The inside of this appliance contains no user serviceable parts. All servicing should be performed by qualified personnel only.

Electricity Safety

1. Make sure that the voltage of your electricity supply is the same as that indicated on the appliance.
2. Always unplug before cleaning or leaving the appliance unused for a long period of time. Keep your hands dry when plugging/unplugging.
3. To avoid fire hazard, NEVER put the cord under rugs, near heat registers, radiator, stoves or heaters.
4. Do not use this appliance if the cord has been damaged to avoid fire or electric hazard.
5. Keep the cord out of heavy traffic areas and where it will not be tripped over.
6. Do not operate any humidifier with a damaged cord or plug. Discard the appliance or return to an authorized service facility for examination and/or repair.
7. Do not run cord under carpeting. Do not cover cord with throw rugs, runners, or similar coverings. Do not route cord under furniture or appliances. Arrange cord away from traffic area and where it will not be tripped over.
8. **WARNING:** To reduce the risk of fire or electric shock, do not use this humidifier with any solid-state speed control device.
9. This appliance has a polarized plug (one blade is wider than the other). To reduce the risk of electric shock, this plug is intended to fit in a polarized outlet only one way, If the plug does not fit fully in the outlet, reverse the plug. If it still does not fit, contact a qualified electrician. Do not attempt to defeat this safety feature.

FOR HOUSEHOLD USE ONLY

Gentle Reminder



Check the appliance regularly and refer to TROUBLESHOOTING or contact our customer support if it shows any of the following signs:

- Power cord or plug is damaged.
- Loud noise, unusual smell or excessive heat.

Specifications

Model	DR-HHM002S
Input	AC 120V 60Hz
Rated Power	26W
Water Tank Capacity	5L

KNOWING YOUR HUMIDIFIER

Package Contents

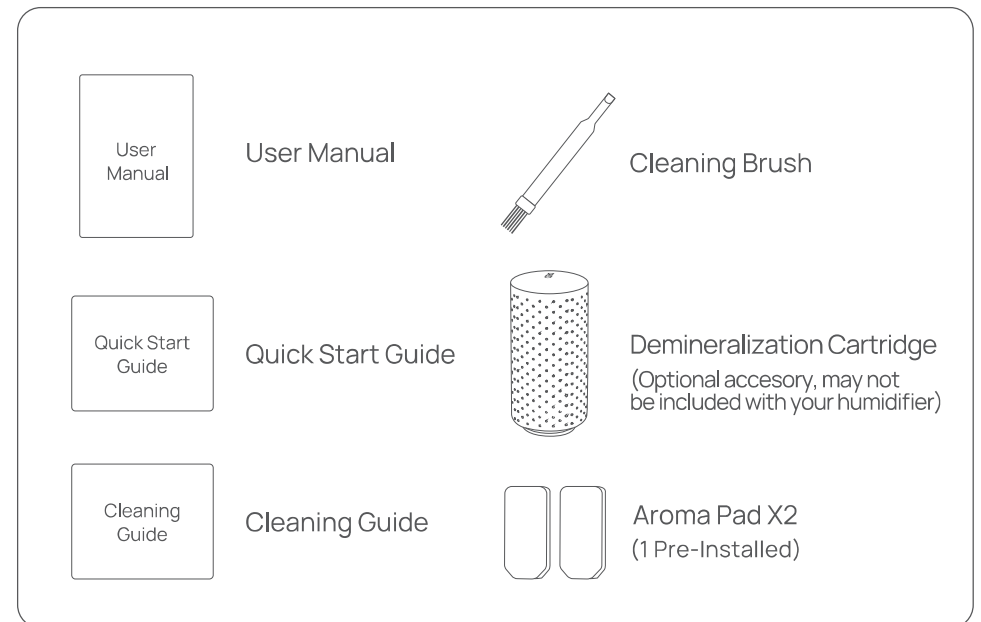
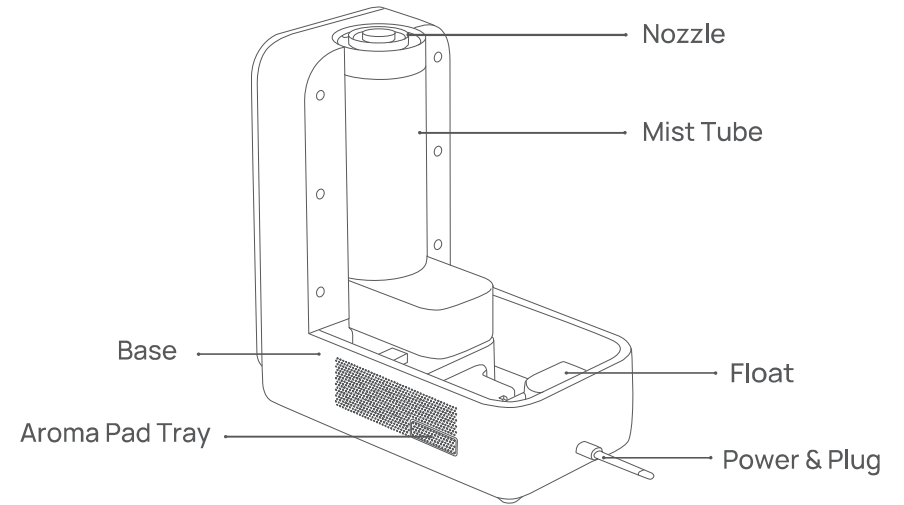
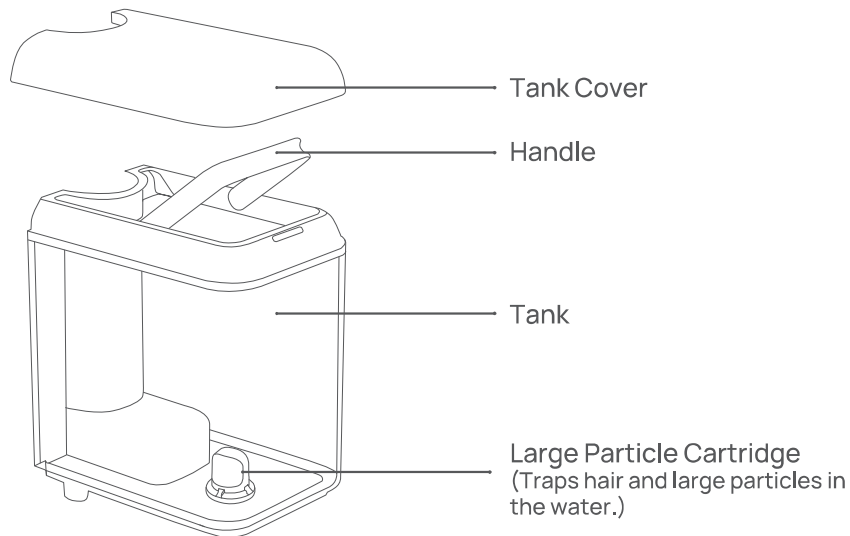
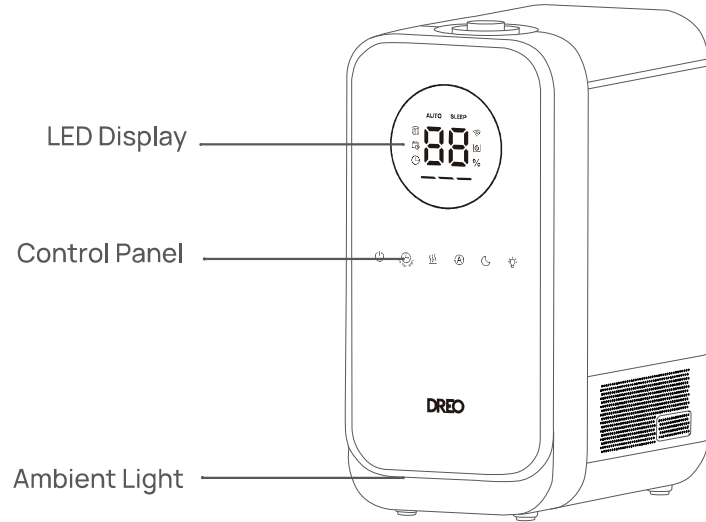

02



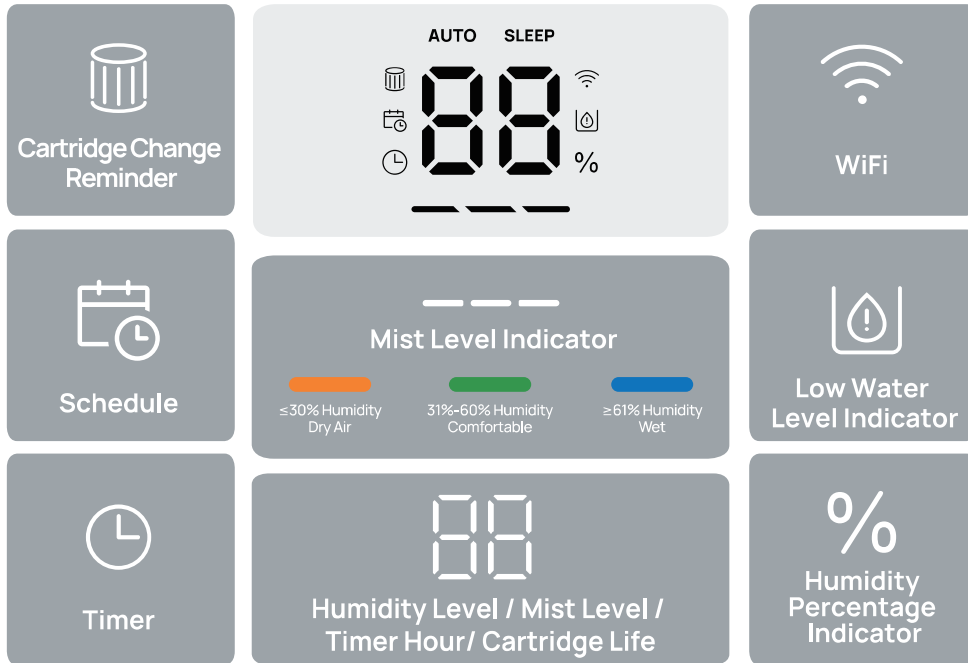







LED Display



Note:

- When humidity levels are below 10%, the display will show “LO”.
- When humidity levels are above 90%, the display will show “HI”.
- When the water is low, the Water Tank Level indicator will flash for 5 seconds then the humidifier will switch to standby.
- When receiving Software upgrades, the display will show “UP”, the humidifier can't be operated until the update ends.
- When the Cartridge life is below 20% the cartridge change reminder  will turn on. You can long press the  for 5s or reset the cartridge life through the Dreo app.
- The Mist Level Indicator color will change according to the room humidity level (see manual page for more information).
- The amount of total dissolved solids (TDS) in water may influence cartridge life. The cartridge life indicator is for reference only.

Control Panel

 Power Button	Turn the humidifier on/off. Long press for 10 seconds to restore to factory settings.
 Manual Mode Button	Switch between Low/Medium /High mist level
 Sleep Mode Button	Turn Sleep Mode on In Sleep Mode, the humidifier will switch to low mist, beep sounds and the ambient light will be turned off. Note: You can turn these beep sounds on/off through the Dreo app.
 Auto Mode Button	Turn Auto Mode on Touch the Auto Mode button to increase the target humidity by 5%. (Target humidity ranges from 30% to 90%.) In Auto Mode, mist level is adjusted according to your target humidity. Press the  and the  button simultaneously to exit auto mode.
 Timer Button	Select to set a timer (0-12H) Long press for 5 seconds to enter WiFi settings.
 Humidity Indicator Light	Turn the ambient light on/off

Humidity Indicator Light

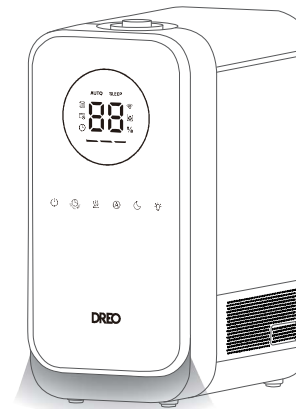

Humidity Light Color	Humidity Level
Yellow	≤30%
Green	31% - 60%
Blue	≥61%

The ambient and mist level indicator lights will change according to your room humidity level.

CONNECTING TO YOUR HUMIDIFIER

03







Before connecting the appliance to your mobile device, please scan the QR code on the left or go to the app store and search “**Dreo**”, then select and download the app.

This device includes the radio transmitting module whose CMIIT ID is FCC ID: 2A3SYHHM002



You can use the Dreo app to connect your smart appliance to **Amazon Alexa** or **Google Assistant**. Please follow the in-app instruction to set up your voice assistant.

NOTE: You must create a Dreo account to access voice assistants.

- 1 Launch Dreo and sign in or create account by following in-app instructions.
- 2 Enable Bluetooth on your mobile device and plug in your humidifier.
- 3 Hold the Timer button  for 5 seconds to start WiFi connection settings. (Tip: The WiFi icon  will keep flashing when pairing.)
- 4 Tap + **Add Device** and select HM512S.
- 5 Follow in-app instructions to complete WiFi connection.
- 6 You're now ready to control the appliance on your app. (Tip: To restart connection settings, hold the  button again for 5 seconds.) Long press 10s the power button  to unpair WiFi and restore factory settings).

USING YOUR HUMIDIFIER

04

Before Use

When using your humidifier for the first time, remove the wraps and follow the steps below.

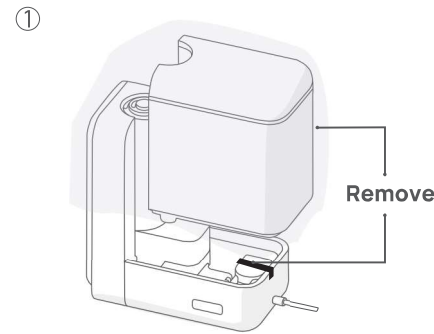

Remove the yellow label on the base and all the plastic wraps around your humidifier.

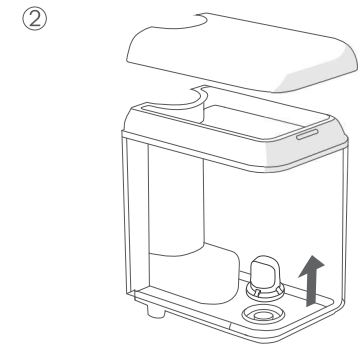

Detach the included cartridge. Note: Do not remove the water valve below the cartridge.

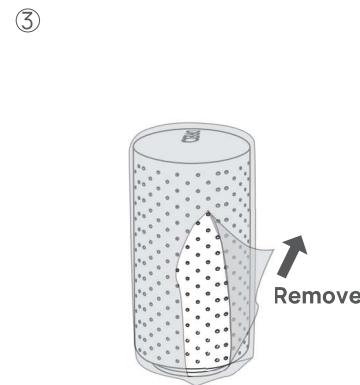

Unbox the demineralization cartridge and remove all the wraps (if included).

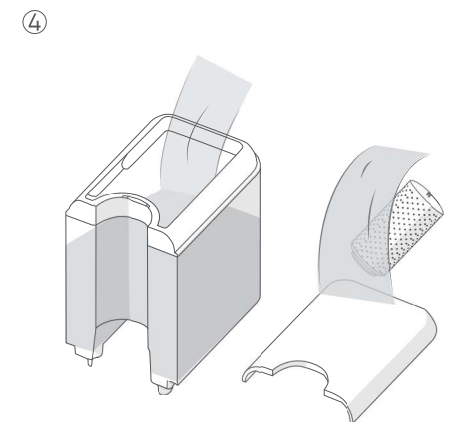

Rinse all parts with water.

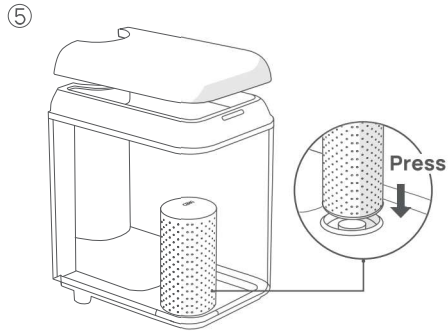

Attach the demineralization cartridge to the tank. If your humidifier doesn't include it, replace back the original cartridge.

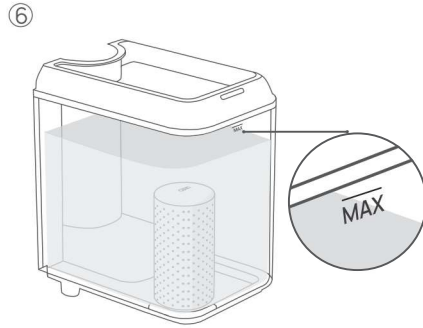

Fill the tank with water, making sure it doesn't pass the MAX line.

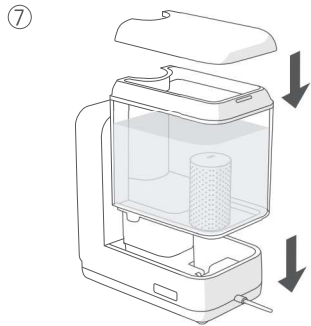

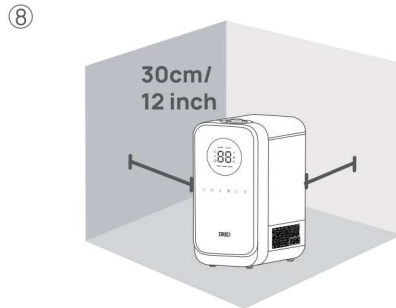

Put the water tank back in place and close the top cover.





Place the humidifier on a flat, level surface, keeping at least 30 cm / 12 inch away from walls or any major obstacles.

General Operations

- 1 Plug the humidifier into an electrical outlet.
- 2 Touch  to turn on/off the humidifier.
- 3 Touch  to switch between Low, Medium and High mist settings.

Mist Level Indicator



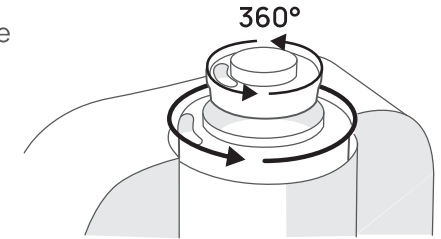

Mist Level	Display
Low	
Medium	
High	

- 4 Adjust the direction of the mist with the 360° rotating nozzle.





Auto Mode

In Auto Mode, mist level is adjusted according to your target humidity.

- Touch the  button to turn on Auto Mode.
- Touch the  button to increase the target humidity by 5%. (Target humidity ranges from 30% to 90%.)
- Touch the  and  buttons simultaneously to exit Auto Mode.



Demineralization Cartridge Life

- You can check your demineralization cartridge status through the Dreo app.
- When cartridge life is below 20%, the  indicator on the LED display will light up. It is recommended to change the cartridge as soon as possible.
- Long press  for 5s or go to the Dreo app to reset the cartridge change reminder.

Note:

Differences in the amount of total dissolved solids (TDS) in water among households may influence demineralization cartridge life. The cartridge life indicator is for reference only.

Sleep Mode

- Touch the  button to enter Sleep Mode. In Sleep Mode, the humidifier will switch to low mist. Humidity indicator light and beep sounds will be turned off.
- Touch the  button or the  button to exit Sleep Mode.

Adding Essential Oil

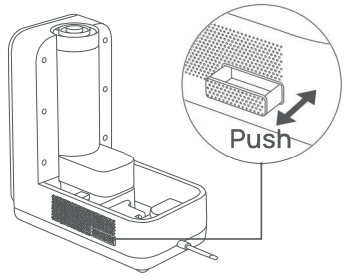

① Push to open the aroma pad tray.

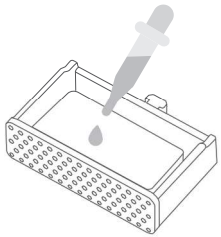

② Add 5-10 drops of essential oil on the aroma pad.

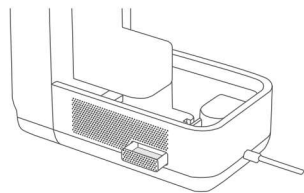

③ Put the aroma pad tray back in place.

Note:

- Add essential oils on the aroma pad only. Do not add into the water tank or any other places.
- The scent may be soft, this humidifier is not intended to work as an aroma diffuser.
- The scent level cannot be adjusted.
- It is recommended to change the aroma pad on a weekly basis.

CLEANING AND MAINTENANCE

05



- Always turn off and UNPLUG the humidifier before any cleaning or maintenance.
- Do not clean the main body under running water.
- Do not let water splash into the air outlets.
- Do not use any chemical agents when cleaning the humidifier.
- Store in a cool, dry place and cover it to protect from dust.
- Do not overfill the humidifier due to the potential risk of electric shock.

Routine maintenance

①

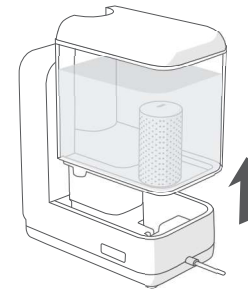

Detach the water tank & drain any remaining water.

②



Remove the demineralization cartridge and rinse with water.

③

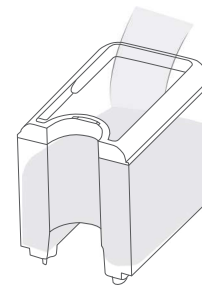

Rinse the tank (warm water).

④

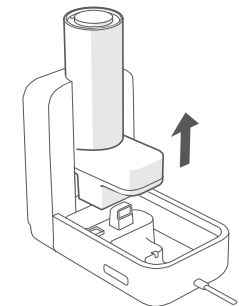

Remove the mist tube and rinse it with warm water.

⑤

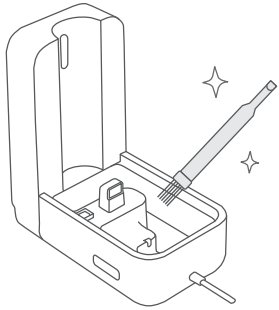

Gently clean the base with a soft cloth or the included cleaning brush.

⑥

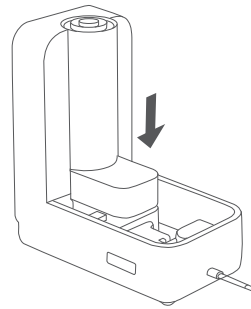

Attach the mist tube back to the base.

⑦

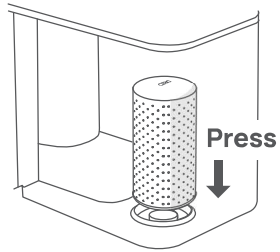

Attach the demineralization cartridge to the water tank.

⑧



Fill the tank with room-temperature water. **DO not fill with hot water.**

Descaling

RECOMMENDED ONCE A MONTH

①

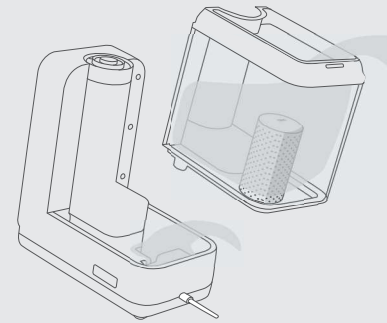

Drain any remaining water from the tank and the base.

②

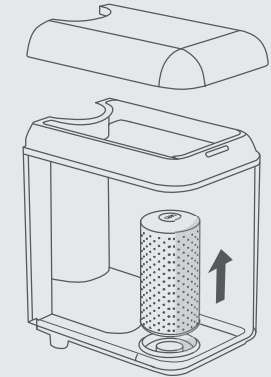

Remove the demineralization cartridge.
Note: Do not remove the water valve below the cartridge.

③

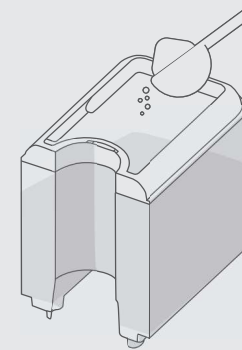

Fill the tank with a solution of bleach and water (one teaspoon of bleach for each gallon of water.) Replace the tank cover and shake around the tank.

④



Attach the water tank to the base. Let it sit for 15-20 minutes.

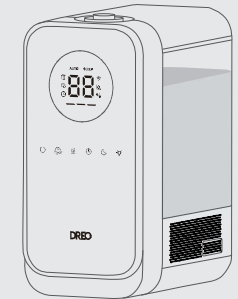

④

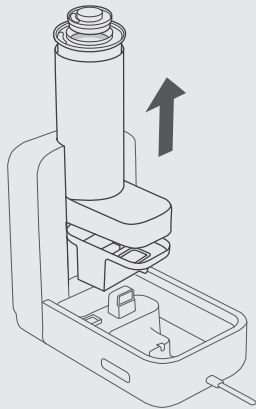

Remove the mist nozzle, mist tube, noise silencer and float.

⑤

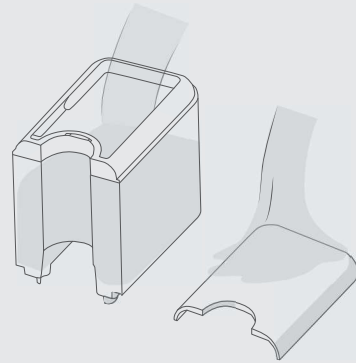

Remove the tank and detach the cover, drain any remaining solution from the tank and the base. Rinse the tank with water until the bleach smell is gone.

⑥

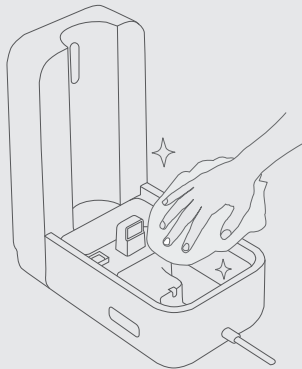

Clean the base with a soft cloth or the included cleaning brush to remove excess of mineral deposits. Make sure all parts are dry before reassembling your humidifier.

Reassembling

①

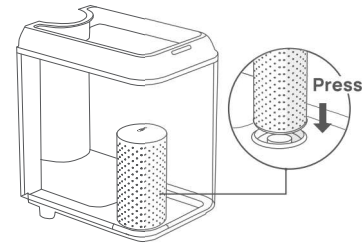

Place the demineralization cartridge back into the tank. Make sure the demineralization cartridge is in place and press down to secure.

②

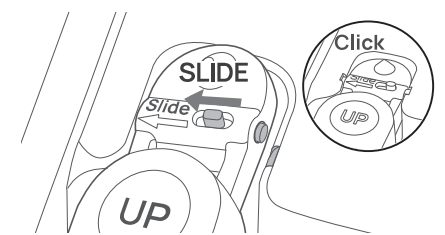

Place the float back into the base chamber.

- Make sure the correct side of the float is facing up.
- Align the prongs with the brackets then press until you hear the "click".

③

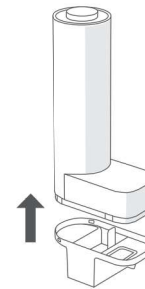

Attach the water separator to the mist tube. Make sure the two parts click in place.

④

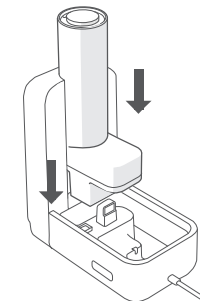

Place the mist tube and the water separator over the base.

⑤

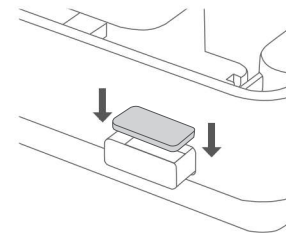

Place the aroma pad back into the aroma pad tray.

⑥

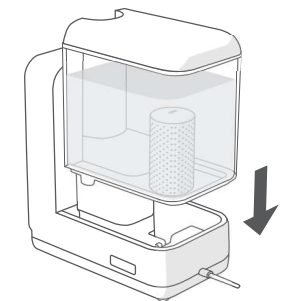

Put the water tank back in place and close the tank cover.

Is Your New Humidifier Leaking?

REMOVE

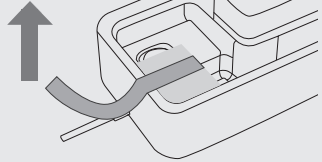

Make sure to remove the protective foam.

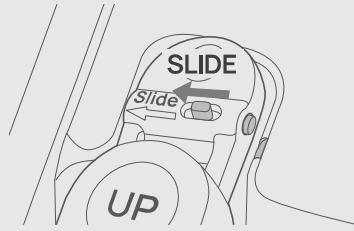

Fix the left prong on the bracket, then slide the other prong to secure the float in place.

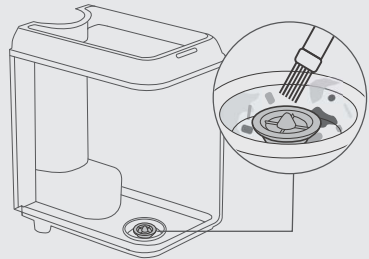

Remove any particles or hair blocking the water valve.

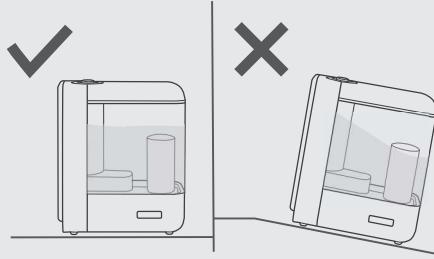

Make sure the humidifier is placed on a flat surface.

Contact Customer Service If...

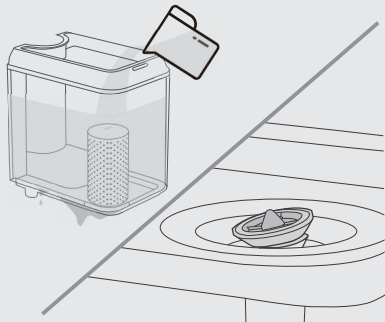

The water valve is not flat or the tank leaks water when refilling.

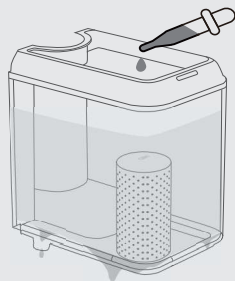

Your water tank has leakage due to prolonged use of essential oils.

If your humidifier keeps leaking water, please contact customer support (see page 21).

TROUBLESHOOTING

06

My humidifier does not work.

1. Make sure that the cord is connected to a powered outlet and the mains voltage corresponds with the voltage indicated on the humidifier.
2. The humidifier will shut down automatically in the event of low water.
3. Check the water tank is installed properly.
4. Check to see if the humidifier is in Auto Mode. Depending on Auto Mode settings, the humidifier may automatically turn off when the humidity level is above the target level.

My humidifier is not misting.

1. Turn the mist level to a higher setting.
2. The base has too much water. Empty the base and refill the water tank (not the base).
3. Please check whether the air inlet is blocked.
4. Make sure the nozzle is not blocked.
5. Make sure the humidifier is not a flat surface.
6. The water temperature may be too low. Turn the mist level to the highest setting and let it run for a while, then adjust to the desired setting.
7. If the water tank or base have been washed with detergent, rinse thoroughly with clean water to remove any remaining detergent.

There is white dust in the water tank.

1. You should descale the humidifier regularly. Using purified or distilled water can help prevent the formation of scale.
2. The demineralization cartridge has expired, replace it as soon as possible.

The mist produces an unpleasant smell.

1. Use purified or distilled water only. It is not recommended to use tap water.
2. Change water regularly to avoid dirty water accumulation.
3. Clean the humidifier and keep it dry for 12 hours with the cover detached.
4. Clean the aroma pad tray, change the aroma pad.

Water leaks from my humidifier.

1. Make sure the silicone sealing ring around the water outlet valve is secure.
2. Avoid running the humidifier in a room with over 60% relative humidity.
3. Wipe any excess water.
4. Do not shake the humidifier.
5. Make sure to place the humidifier on a flat, level surface.
6. Check the water tank for leaks. If there are leaks, contact Customer Support (see page 18).

The demineralization cartridge life indicator is not accurate.

1. The amount of total dissolved solids (TDS) in water vary in different areas, which may influence filter life.
2. Forgetting to place the cartridge after cleaning can also causes inaccuracy in cartridge life indicator.

If your problem is not listed or still persists, contact our Customer Support (**see page 21**).

Default 12-Month Warranty

This appliance is covered by Dreco warranty for 12 months from the date of its original purchase.

Extend Your Warranty

Extend your warranty by registering your new appliance on our website <https://dreco.com/warranty>.

The warranty will not apply in cases of:

- Accident, misuse, or repairs performed by unauthorized personnel.
- Any unit that has been tampered with or used for commercial purposes.
- Normal wear and tear of wearable parts.
- Use of force, damage caused by external influences.
- Damage caused by non-observance of the User Manual, e.g. connection to an unsuitable mains supply or noncompliance with the instructions.
- Partially or completely dismantled appliances.
- Defects caused by or resulting from damages from shipping or from repairs, service, or alteration to the product or any of its parts that have been performed by a repair person not authorized by DREO.

We can only provide after-sales service for products that are sold by DREO or DREO authorized retailers and distributors. If you have purchased your unit from a different place, please contact your seller for return and warranty issues.

FCC REQUIREMENT

Any changes or modifications not expressly approved by the party responsible for compliance could void the user's authority to operate the equipment.

This device complies with Part 15 of the FCC Rules. Operation is subject to the following two conditions:

- (1) this device may not cause harmful interference, and
- (2) this device must accept any interference received, including interference that may cause undesired operation.

Note: This equipment has been tested and found to comply with the limits for a Class B digital device, pursuant to Part 15 of the FCC Rules. These limits are designed to provide reasonable protection against harmful interference in a residential installation. This equipment generates, uses, and can radiate radio frequency energy, and if not installed and used in accordance with the instructions, may cause harmful interference to radio communications. However, there is no guarantee that interference will not occur in a particular installation. If this equipment does cause harmful interference to radio or television reception, which can be determined by turning the equipment off and on, the user is encouraged to try to correct the interference by one or more of the following measures:

- Reorient or relocate the receiving antenna.
- Increase the separation between the equipment and receiver.
- Connect the equipment into an outlet on a circuit different from that to which the receiver is connected.
- Consult the dealer or an experienced radio/TV technician for help.

This equipment complies with FCC radiation exposure limits set forth for an uncontrolled environment. This equipment should be installed and operated with a minimum distance of 20cm between the radiator & your body. This transmitter must not be co-located or operating in conjunction with any other antenna or transmitter.

Model No.:DR-HHM002S
Rev_1.5_EN

We're Here to Help!

 (888) 290-1688 Mon - Fri, 9:00 am-5:00 pm PST/PDT

 www.dreo.com

 support@dreo.com

 Shenzhen Hesung Innovation Technology Co., LTD
26F, Bldg A7, Creative City, Shenzhen, China



MADE IN CHINA