



# **Ceiling Fan Manual**



# To Dear Customer

Congratulations on your purchase of the new ceiling fan

**It's a great honor for you choose our product, please read the manual carefully before installation. Please also feel free to contact our professional customer service for assistance if you have any questions or product problems, thank you!**

w w w . p m w f a n . c o m

Model No: DY1132-5B/42  
DY1132-5B/52

# Ceiling Fan

## Installation Manual

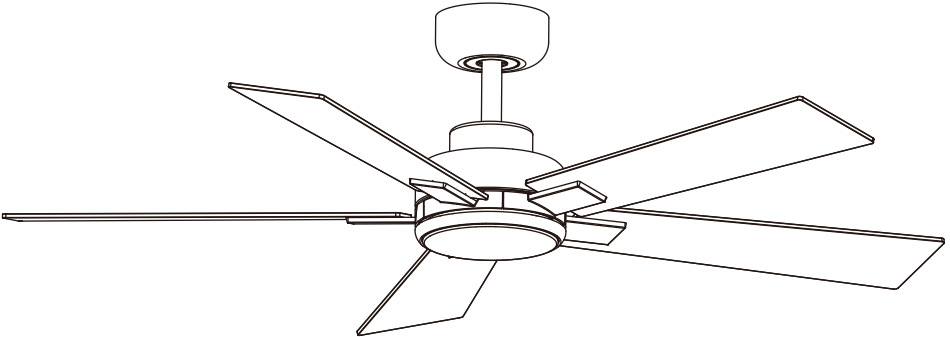

THANK YOU

We appreciate the trust and confidence you have placed in us through the purchase of this ceiling fan. We strive to continually create quality products designed to enhance your home. Thank you for choosing us!

---

Visit [www.pmwfan.com](http://www.pmwfan.com) for further assistance.

# SAFETY PRECAUTIONS

1.  The fan can only operate properly with all blades installed. If the fan is started without blades, it will beep and automatically shut off.

2.  If you are unfamiliar with electrical installations, please consult or hire a qualified electrician.

3.  Before operating any electrical connections of the fan, be sure to disconnect the main power by removing the fuse or turning off the circuit breaker.

4.  Do not use the fan with a dimmer switch or a speed controller together, as it may damage the fan. It should only be operated using its own built-in speed settings.

5.  The mounting point for the fan must be capable of supporting at least 77 pounds (35kg). If installing on a ceiling outlet box, use the mounting screws provided. Most outlet boxes typically used for installing lighting fixtures cannot be used for installing fans and may need to be replaced. If in doubt, please consult a licensed electrician.

6.  To reduce the risk of electric shock, this fan must be installed with an isolating wall switch.

7. Ensure the fan's electrical connections are properly grounded to prevent any electrical hazards.

8. When deciding where to mount the fan, please ensure that there is at least 30 inches (76 cm) of space between the fan and any walls or other obstacles that its blades might hit. The greater this distance, the more effective the airflow generated will be. After installing, please ensure that the blades are at least 7.5 feet (2.3 meters) above the ground.

9. When complete, check that all screws and fasteners are tightened to avoid noise from loose parts.

10. Before changing the direction of rotation, ensure that the fan has completely come to a stop to avoid further damaging the motor.

11. Fan fasteners can loosen over time. Inspect the key components of the fan, such as the connections of blades, screws, and bracket, at least once a year to ensure everything remains secure.

12. If the fan experiences abnormal rotation or vibration, please stop using it and contact the manufacturer or a professional.

13. Turn off the fan before cleaning. Please use dry cloth or slightly wet one instead of using water or cleaning agent.

Note: The important warnings and instructions outlined in this manual do not guarantee coverage of all possible scenarios that may occur.

**WARNING:** Changes or modifications to this unit not expressly approved by the party responsible for compliance could void the user's authority to operate the equipment.

**NOTE:** This equipment has been tested and found to comply with the limits for a Class B digital device, pursuant to Part 15 of the FCC Rules. These limits are designed to provide reasonable protection against harmful interference in a residential installation. This equipment generates, uses and can radiate radio frequency energy and, if not installed and used in accordance with the instructions, may cause harmful interference to radio communications.

However, there is no guarantee that interference will not occur in a particular installation. If this equipment does cause harmful interference to radio or television reception, which can be determined by turning the equipment off and on, the user is encouraged to try to correct the interference by one or more of the following measures:

- Reorient or relocate the receiving antenna.
- Increase the separation between the equipment and receiver.
- Connect the equipment into an outlet on a circuit different from that which the receiver is connected.
- Consult the dealer or an experienced radio/TV technician for help.

## Battery Safety Tips:

1. Please keep the battery out of the reach of children. Swallowing it can cause severe injury within 2 hours, including chemical burns or death. If ingested, seek medical attention immediately.
2. If the battery is misused or damaged, flammable liquid may leak from it. You should avoid contact with this liquid. If accidental contact occurs, rinse with contact with the eyes, seek medical attention immediately. The liquid emitted from the battery can cause irritation or burns.
3. Do not expose the device or battery to excessive temperatures.
4. Be aware of the risk of short-circuiting the terminals of battery-powered devices or batteries with metallic objects.
5. Do not use modified or damaged batteries.
6. Non-rechargeable batteries should not be charged.
7. Do not mix different types of batteries or new and old batteries.
8. Batteries should be inserted with the correct polarities.
9. Depleted batteries must be removed from the device and disposed of safely.
10. If the device is to be stored for a long period without use, batteries should be removed.
11. Battery: AAA 1.5V

## CHECK THE ROOM DIMENSIONS

- First, check the room size, and then ensure there is at least 30 inches (76 centimeters) of clearance or space between the fan and any walls or other obstacles that the fan blades might hit to optimize airflow. After installation, please verify blades are at least 7.5 feet (2.3 meters) above the ground. It can also be installed on inclined roofs with a maximum slope of 15°.

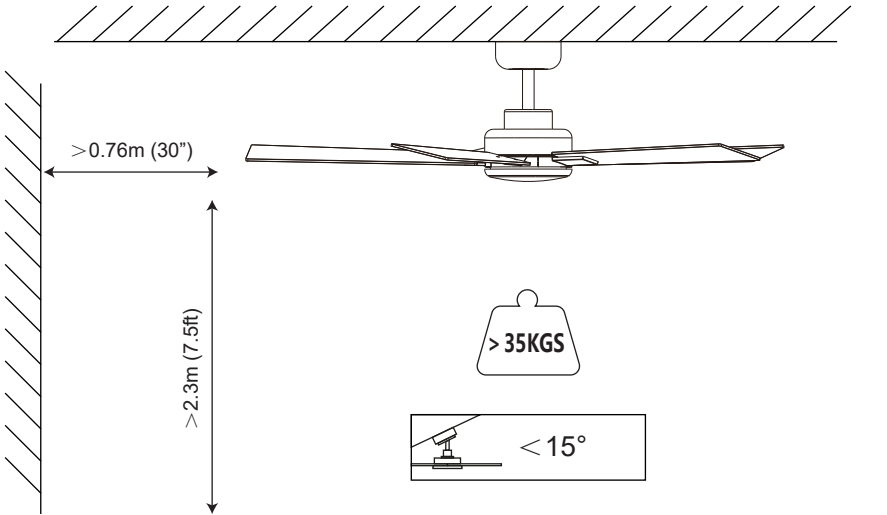

## TOOLS NEEDED



Step  
ladder



pliers

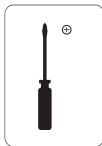

Phillips  
screwdriver

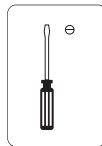

Flat blade  
screwdriver



Electrical  
tape



tape  
measure

# PACKING LIST



Before unpacking the fan, please check that all parts are included, as listed below:

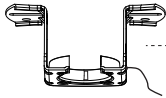

1.Bracket

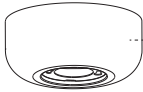

2.Canopy



3.Decorative ring

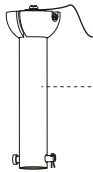

4.Downrod



5.Coupling cover



6.Motor Assembly



7.Light Fixture

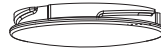

8.Lampshade



9.Blade arm

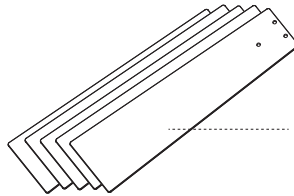

10.Blade

## Remote control unit

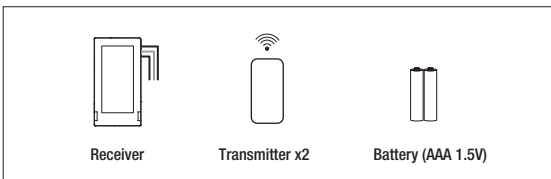

## Blade balance kit

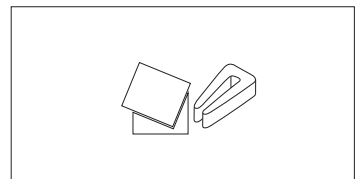

## Hardware bag

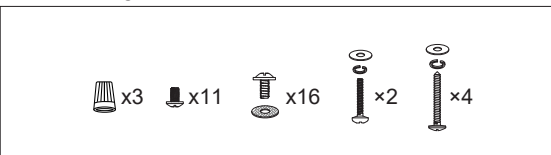

## Installation manual

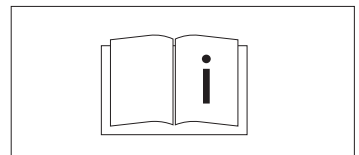

• Note: The illustrations in this manual are for explanatory purposes only and may not correspond to actual units.

## CHOOSING THE RIGHT LOCATION

- If installing on a ceiling outlet box, check its suitability first. Most outlet boxes intended for lighting are not suitable for fans and may need replacing. Consult a licensed electrician if unsure.

**Check the outlet box:**

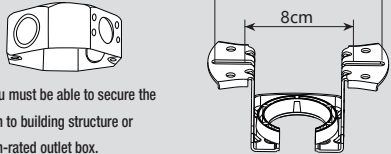

You must be able to secure the fan to building structure or fan-rated outlet box.

- The bracket provided is suitable for outlet boxes with sizes from 8-13.5cm

## HANGING BRACKET INSTALLATION

- Before starting any work, make sure that the power to the main power cabinet is safely turned off. This can be done by either removing the fuse or switching off the circuit breaker.
- Make sure that ceiling joists are strong enough and of adequate size to support the weight of the fan of about 35 kg.
- Use different screws to fix the bracket according to the ceiling material. Can be installed on <math><15^\circ</math> sloped roof.



- ① remove two screws from the bracket (without fully removing them).

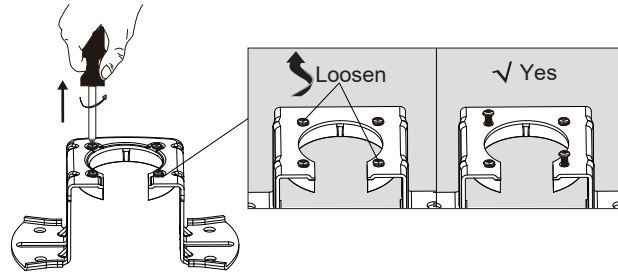

- ② Use different screws to secure the bracket according to the ceiling material.

**Outbox**

**Solid Wall Ceiling**

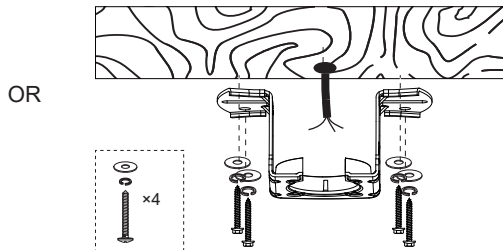
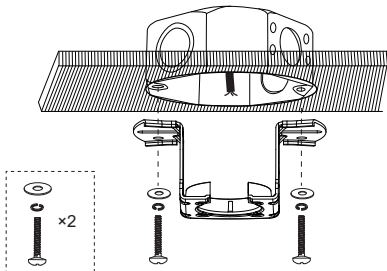

Check whether bracket is securely installed or not.

## BASIC ASSEMBLY OF THE FAN

- ① Detach the downrod assembly.

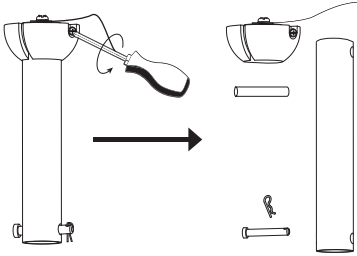

- ② Remove the three pre-installed screws from the motor assembly

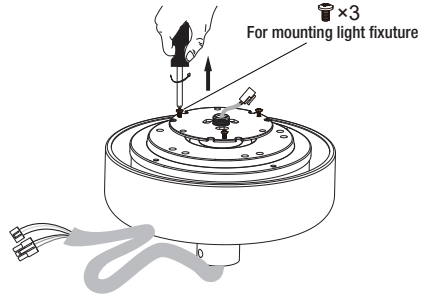

- ③ Assemble the blades and blade arms.

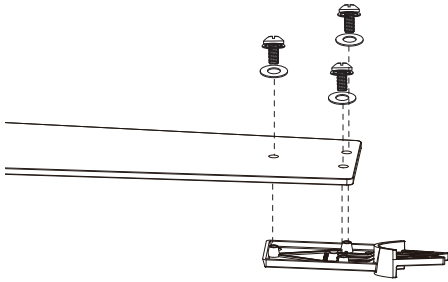

- ④ Align the holes on the blade arms with the corresponding ones on the motor assembly. Then, use the blade arm screws to secure the blades in place and tighten them. Repeat this step until all blades are installed.

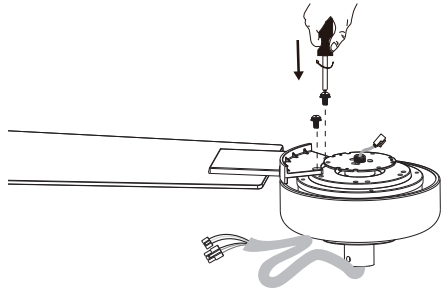

- ⑤ Align the holes on the light fixture with the corresponding holes on the motor assembly, then connect the wiring terminals. Use the 3 screws you removed to install the light fixture onto the motor assembly.

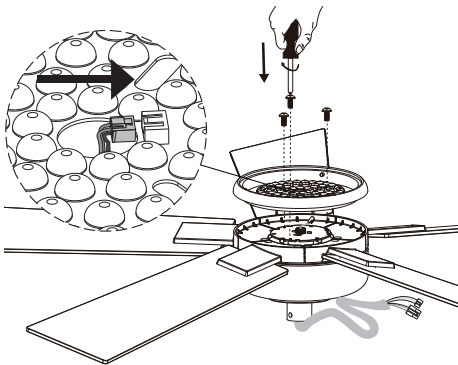

- ⑥ Loosen the two screws on the coupling. Route the wires through the downrod. Align the holes at the bottom of the downrod with the holes in the coupling. Ensure the safety pin passes through the holes in the coupling and downrod, and insert the R-pin into a hole near the end of the safety pin to secure it. Finally, tighten the two screws on the coupler.

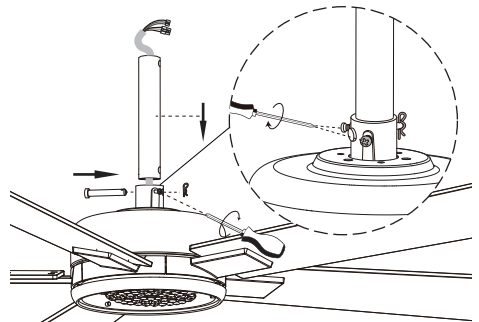

- ⑦ insert the cover, canopy cover, canopy and the ball onto the downrod in the correct order. insert the cross pin into the holes to the top of downrod to ensure it is properly installed in the slot. and then align the holes and tighten the two screws.

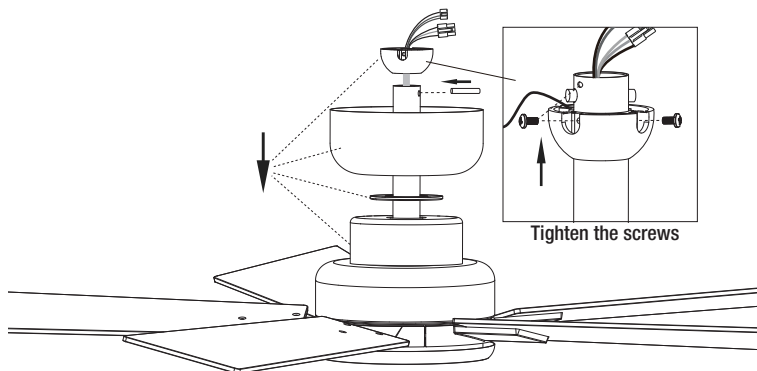

- ⑧ Lift the pre-assembled fan and place it onto the bracket. Rotate the fan until the groove on the ball aligns with the slot on the bracket.

- ⑨ Put the receiver in the bracket.

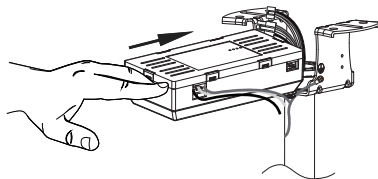
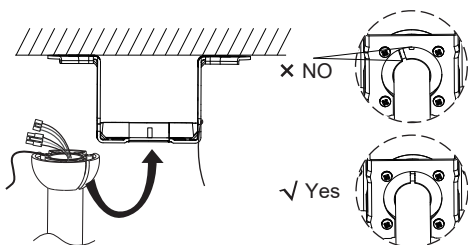

## WIRING

- ① Wire in accordance with the wiring diagram



If you are not familiar with wiring or have any doubts, please consult an electrician.

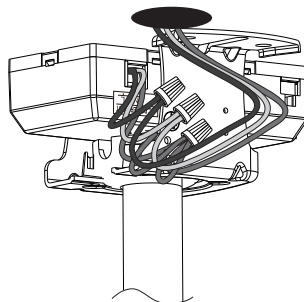

## WIRING DIAGRAMS

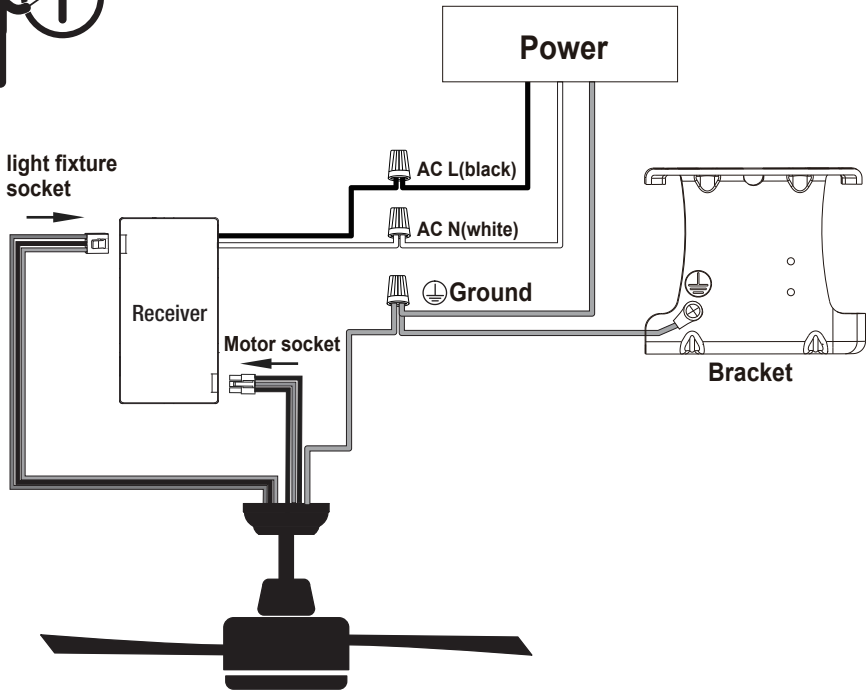

## MOUNTING REMAINING PARTS

- ① Slide the canopy upwards towards the bracket and align the holes with the screws. Rotate the canopy clockwise until it locks into place, then tighten the screws; push the bottom cover of the canopy upwards to fit it into the canopy.

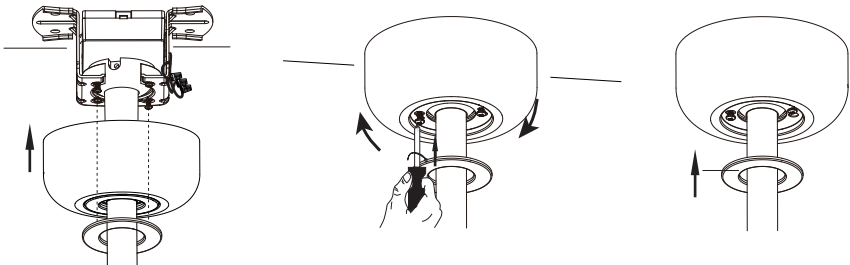

- ② Align the locking points on the lampshade with the slots on the light fixture. Rotate the lampshade until it is securely fixed in place.

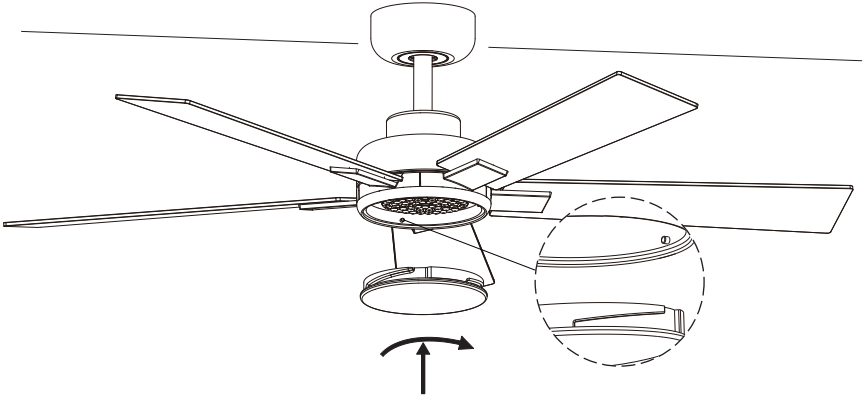

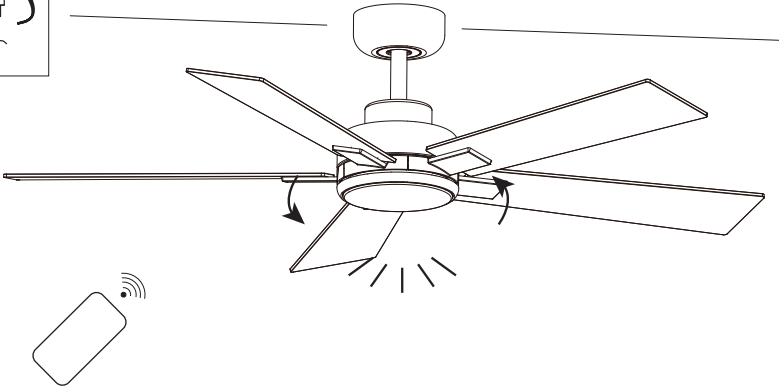
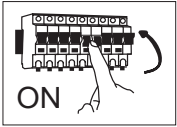

## START THE FAN



## REMOTE CONTROL OPERATION

### Button Function-1

1 - 6	Fan speed control.
	Stop the fan.
LIGHT ON	Turn on the light.
LIGHT OFF	Turn off the light.
WW	Tap once: Warm white (Tip: Hold it and light color temperature will change from cool to warm)
NW	Natural white.
DW	Tap once: Day white (Tip: Hold it and light color temperature will change from warm to cool)
	Forward/Reverse.
	Sleep Wind.
+	Increases the light level.
-	Decreases the light level.
1H 3H 6H	Preset timer for fan to stop autormally. E.g. if timer set at 1h and then 3h, fan will stop at 3h. Setting default to last press. To engage time this has to be last button pressed after selecting speed, pushing any other button after selecting timer will cancel it.

### Remote control pairing









- Note: Your remote control has been factory pre-set, so no pairing is required for first-time use. Re-pairing is only necessary if the remote control malfunctions.

1. Install 2 batteries(AAA 1.5V) into the remote controller.
2. Turn on the power. Within 10 seconds of powering on the fan, press and hold the "1" and "2" buttons for about 3 seconds. After a beeping sound , pairing is complete, and the fan is ready for use.

About the light memory function : Automatically remembers the brightness and color temperature of the light.

## REMOTE CONTROL OPERATION

### Button Function-2

	Fan Speed “-”.
	Fan Speed “+”.
	Stop the fan.
	Forward/Reverse.
	LED On/Off.
	Light brightness “+”.
	Light brightness “-”.
	Sleep Wind.
CCT	Change color temperature.
1H 3H 6H	Preset timer for fan to stop automally. E.g. if timer set at 1h and then 3h, fan will stop at 3h. Setting default to last press. To engage time this has to be last button pressed after selecting speed, pushing any other button after selecting timer will cancel it.

### Remote control pairing

- Note: Your remote control has been factory pre-set, so no pairing is required for first-time use. Re-pairing is only necessary if the remote control malfunctions.

- 1.Install 2 batteries(AAA 1.5V) into the remote controller.
- 2.Turn on the power supply to the fan. Within 5 sec, press and hold the “-” and “” button for about 3 sec. Once the receiver has detected the frequency, receiver will “Beep Beep” twice.Programming process is completed and fan is ready to use.

About the light memory function : Automatically remembers the brightness and color temperature of the light.

# TROUBLESHOOTING



**WARNING:** Before attempting any repairs, ensure that the power cabinet is turned off

Problem	Troubleshooting
The fan will not start.	<input type="checkbox"/> Check the main and branch fuses or circuit breakers.
	<input type="checkbox"/> Check the wire connections to the fan.
	<input type="checkbox"/> Make sure the remote control has been paired.
The fan sounds noisy.	<input type="checkbox"/> Make sure all motor housings are secured and tightened.
	<input type="checkbox"/> Make sure the screws that attach the fan blade to the motor hub are tight.
	<input type="checkbox"/> Check for any friction between the fan blades and the motor housing.
	<input type="checkbox"/> Allow a 24-hour "break-in" period. Most noises related to the new fan will disappear during this time.
	<input type="checkbox"/> Check if there is any friction between the light or the base cover and the blades.
	<input type="checkbox"/> Ensure the distance between the canopy and ceiling is minimal, and it should not touch the ceiling.
	<input type="checkbox"/> Check if the outlet box is securely installed and if rubber washers are used between the bracket and the outlet box.
The fan is rotating, but the airflow is insufficient.	<input type="checkbox"/> The fan may be operating in reverse, causing air to flow upwards.
	<input type="checkbox"/> The fan may be too small compared with the size of the room.
	<input type="checkbox"/> Obstacles in the room may be blocking airflow.

Remote Control Fault Alert Tones Explanation

No.	Buzzer Alert Tone	Problems	Troubleshooting
1	Two short, quick sounds, repeated 6 times with a 1-second interval between each repetition.	motor phase failure	1. Check whether the motor terminal and the controller are properly connected or if the connection is loose. 2. Check if any of the three wires in the motor terminal are loose. If neither of the above issues is present, the controller needs to be replaced. If replacing the controller does not solve the problem, the fan motor itself needs to be replaced.
	A continuous alert sound, ringing 5 times in each instance.		
2	Three short, quick sounds, repeated 4 times with a 1-second interval between each repetition.	Motor stall	1. When the motor engine stops, move the blade to rotate it so as to predict the motor is tight or jammed. If the blades rotate and the motor continues to rotate with inertia without any abnormal noise after releasing them, it indicates that the motor and structural components are properly installed. In this case, the controller needs to be replaced. 2. If the fan blades are too tight, try manually rotating them for 5 revolutions. Then restart the fan, setting the speed to the maximum. If it operates normally after this, keep the fan running at maximum speed for 10 minutes. If any issues persist, the controller needs to be replaced. 3. If the blades cannot be moved at all, check whether any incorrect screws or deformed structural parts are causing the fixed components to jam with the rotating parts. If not, the fan motor needs to be replaced.
	A continuous alert sound, ringing 6 times in each instance.		

## Addressing Fan Wobbling Issues During Operation

If the fan body wobbles during Operation, this is not an indication of a fault (even if it wobbles a few centimeters). To reduce it, you can turn off the fan and then:

1. Check if all the blades are properly secured by tightening the screws.
2. Check the distance between each blade and the ceiling. Measure the distance to the ceiling as shown in the image. If there is a change and you have already tightened the screws, ensure that all blades are the same shape. If any blade appears noticeably different, it could cause wobbling during operation. If you've completed these steps and the wobbling still persists, use the provided balancing kit for dynamic balancing, as follows.

(1) Turn the fan on to its highest speed to maximize the wobble.

(2) Turn off the fan. Select one blade and place a clip on it (see image 2), clipping it to the edge of the blade.

(3) Turn the fan on and set it to the highest speed, checking whether the wobble improves or worsens. If there is no improvement, move the clip to another blade. Repeat this process to determine which blade can reduce the wobble.

(4) Once the blade is determined, leave the clip on it and adjust the clip forward or backward on this blade until the best position is found that provides the most effective result.

(5) Finally, remove the clip and place one of the balance weights on the upper centerline of the blade where the clip was located.

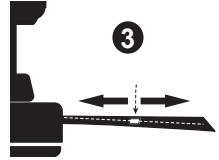
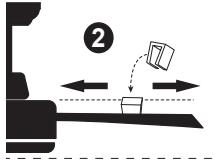
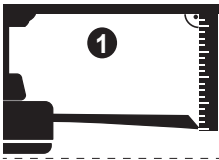

# Ceiling Fan

Questions, problems, missing parts? Before returning to the store,  
visit [www.pmwfan.com](http://www.pmwfan.com) for further assistance.

Retain this manual for future use.

**Manufacturer:** Zhongshan Miaowang Electrical Appliance Co., Ltd.

**Address:** Building C, No.10, Qingfu Road, Henglan Town, Zhongshan City, Guangdong Province, CN

**Website:** [www.pmwfan.com](http://www.pmwfan.com)

**Tech Support Telephone:** +12092272409

**Tech Support Email Address:** [support@pmwfan.com](mailto:support@pmwfan.com)