

Tall Cabinet Installation Instructions

CAUTION: Never use nails to mount cabinets. The use of nails may void your factory warranty, written or implied.

Tools Needed:

- Tape Measure
- Stud Finder
- Level
- Pencil
- Clamps
- Square
- Drill with $\frac{3}{32}$ " Bit
- Phillips Head Screwdriver and drill driver bit

Materials Needed:

- Wood Shims
- $2\frac{1}{2}$ " Trim Head or Flat Head Wood Screws
- $2\frac{1}{2}$ " Round Washer Head Wood Screws 

Before starting the installation

These instructions are intended as supplemental reference for those who have the appropriate skills and experience to safely and successfully install cabinetry, including familiarity with basic carpentry principles and safe and proper tool use. Wall framing and construction can vary greatly, and these instructions may not describe all construction methods. Also, there may be electric, plumbing, gas lines or other utilities behind the wall, for which contact must be avoided during installation. If for any reason after reading these instructions you do not feel confident in the ability to safely and successfully install this cabinetry, please contact a licensed contractor for installation. MasterBrand Cabinets is not responsible for improper installation or property damage.

WARNING: Electric, plumbing, gas lines and other utilities, are frequently installed or embedded behind walls where cabinets are being installed. Before drilling any holes or driving any screws, be sure you will not be making contact with any of these utilities. Failure to follow these instructions may result in property damage and serious or fatal injury. If you do not feel confident in your ability to insure that you will not make contact with utilities behind a wall during installation, please contact a licensed contractor to install the cabinets.

Step 1: Inspect New Cabinets

All cabinets are subjected to quality inspections before leaving the factory, and have been carefully packaged to prevent damage during shipping and handling. Unfortunately, damage may occur occasionally in handling between the factory and the final destination. Inspect each cabinet carefully. If damage is discovered, place the cabinet back into the carton and notify retailer of purchase.

Step 2: Determine Cabinet Placement

Remove baseboard and other objects on the wall area where the cabinets are to be installed. Using a straight edge and a level, find the high point in the floor where the cabinets are to be installed. From the high point, mark a level horizontal line on each wall where the cabinets will be attached. From the level lines, mark another parallel level horizontal line 84" for the tall cabinet heights. The top of the base, tall & wall cabinets will be located at these marks.

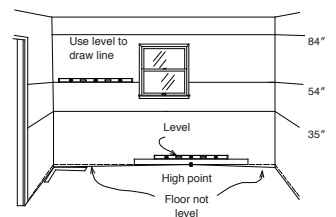

Step 3: Prepare For Cabinet Installation

Locate the studs with a stud finder and mark where the cabinets are to be installed. Remove all the doors, drawers and adjustable shelving from the cabinets before installation. This will reduce weight and allow easier access during installation.

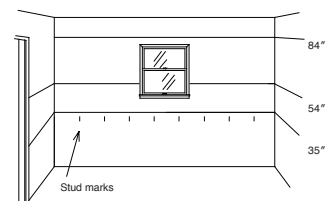

Step 4: Begin Cabinet Installation

Start installing the base cabinets in the corner (if applicable). Follow the base cabinet instructions and work towards the tall cabinet unit. Using clamps, align and join the adjacent cabinets together at the face frames. Make sure that the face frames align both on the face and vertically. With a $\frac{3}{32}$ " drill bit, drill starter holes through the face frames near the top and bottom. Insert and tighten the $2\frac{1}{2}$ " screws.

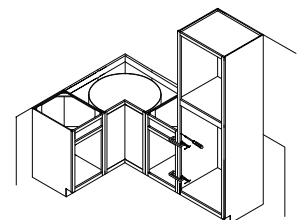

Step 5: Level Cabinets

Check the cabinet to ensure it is level and plumb. Shim to fill uneven areas between the floor and base of the cabinet, and between the wall and the back of the cabinet. Failure to do this step could result in damage to the cabinet. Pay close attention to the areas that the cabinet will attach to the wall, making sure that the cabinet bottom is fully supported.

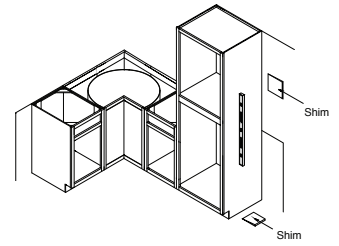

Step 6: Prepare To Anchor Cabinets

Drill through the cabinet back into the prelocated wall studs with a $\frac{3}{32}$ " diameter drill bit, approximately 2" deep. The holes should come no closer than 2" to any inside vertical edge of the cabinet. Two screw holes should be located in the upper section of the cabinet and two in the lower section. Cement, block, brick or tile walls will require anchors for screws or toggle bolts. These will need to be purchased separately, if needed. The size of the hole will need to be sized according to those purchased anchors.

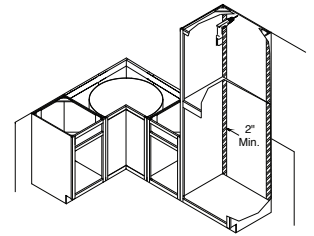

Step 7: Anchor Cabinets To Wall

Insert the 2½" round washerhead screws into the holes until they are nearly tight. Make sure the back is fully supported with shims, as needed, and does not bow into any imperfections in the wall. Ensure that the cabinet is level and plumb, adjust as needed. Tighten the screws fully and check once more to ensure the cabinet is level and plumb. Re-install the cabinet doors, drawers and shelving after all cabinets have been installed.

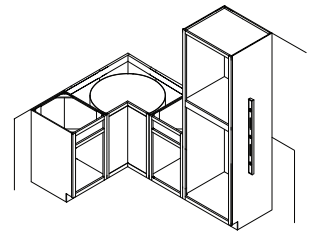

Step 8: Completing the Installation and Alignment

When all of the tall cabinets are securely installed to the walls, the next step is to check each door and drawer for proper alignment. If adjustments are needed, follow hinge adjustment instructions listed below.

IMPORTANT: All doors and drawer fronts must be aligned prior to decorative hardware installation.

Cabinet Care and Maintenance

6-Way Hinge Adjustment

The hinges can be easily adjusted "up and down" by loosening the hinge screws attached to the face frame. Slide the door up or down until aligned and tighten the screws. The hinges can also be adjusted "side to side" and "in and out". See below for details on adjustments.

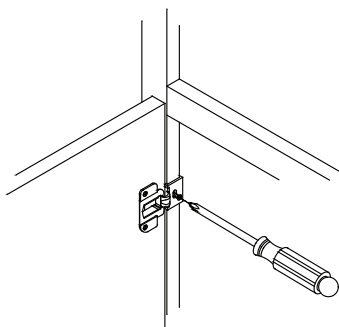

FULL OVERLAY

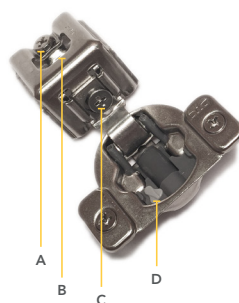

PARTIAL OVERLAY

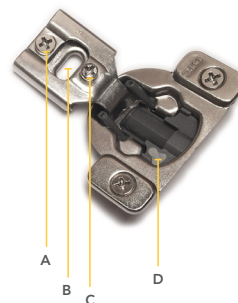

A. In & Out Adjustment
For bowed and warped doors.
(See illustrations below.)

B. Up & Down Adjustment
For misaligned doors. Loosen screws, adjust, then re-tighten screws.

C. Side to Side Adjustment
For gaps between double doors.
Clockwise to adjust out, counter clockwise to adjust in.

Trouble Shooting Guide: Problems You Can Handle

Even though your cabinets must pass rigid quality inspection procedures, irregularities arise as a result of shipping and handling procedures. Also, certain errors during the installation process may cause problems that are not the fault of the cabinet manufacturer. Listed below are several conditions and causes, as well as remedies for those situations.

Problem	Possible Cause	Solution
Cabinet doors do not align vertically (up and down).	A hinge is twisted or the cabinet is out of alignment or "racked."	Make sure the cabinet is plumb and level. Adjust the door hinges.
Double doors on a wall or base cabinet do not line up.	This could be the result of improper cabinet installation. The cabinet is out of alignment and is not set level and square (plumb).	Loosen the cabinet from the wall and use shims to properly square up the cabinet. Adjust the door hinges.
Space between the two adjoining doors is too great.	A hinge is out of adjustment.	Adjust the door hinges.
Cabinet drawer does not close evenly.	Drawer alignment is poor.	Manually adjust the drawer guide member.

Cabinet Cleaning: Interior

Cabinet interiors are surfaced with a urethane-coated laminate that resists scuffs, mars and most common household spills. Wipe with a damp cloth or sponge. For food residue or grease, use warm water mixed with mild dishwashing liquid to wipe clean. 5% dishwashing liquid to 95% water is a good ratio. Dry thoroughly. To avoid permanent damage, it is important to clean the spill and dry the surface immediately.

Cabinet Cleaning: Exterior – Wood Cabinets

Wood exteriors are manufactured with a quality finish that protects the wood. Monthly cleaning is recommended. Wipe the surface of the cabinets with a clean damp cloth, and dry with another clean cloth. For general soil or grease, use warm water mixed with mild dishwashing liquid to wipe clean. 5% dishwashing liquid to 95% water is a good ratio. Dry thoroughly. Excess moisture can damage any cabinet finish; areas near the sink, range, dishwasher, oven and baseboards are the most susceptible and must be kept dry. Waxing is not recommended and over time, waxing and polishing compounds may build up on cabinet surfaces forming a hazy, streaked or yellowed appearance.

Cabinet Cleaning: Exterior – Laminate

Laminate cabinets are surfaced with a durable PVC that is colored throughout, allowing for years of outstanding wear and beauty. Monthly cleaning is recommended, using the same procedure described for wood exteriors.

CAUTION:

Avoid using cleaners that contain bleach, ammonia, citrus based products or any type of abrasives (see cleaner label). These cleaners can cause damage to your cabinet finish.

Characteristics of Wood

Authentic woods vary in color and character markings such as streaks, knots and grain patterns. Since the finish stains may attract differently to these grain patterns, some light and dark areas may result. The beauty lies in these natural variations of color and grain that give each cabinet its own individual charm. Over time, changes in the finish color may occur. Because of a natural aging process, the finish can also "deepen" over time, darkening the color of the wood or creating a "shadowing" effect where doors overlap the frame. Due to these minor differences in tone, it may not be possible to match the finish color of existing cabinets exactly when replacing doors or adding cabinets at a later date. Lighter & natural finishes and glazes highlight the inherent qualities of genuine wood to create a truly beautiful product. Only select solid hardwoods and hardwood veneers have been used to construct your cabinetry. The beauty of these genuine woods lies in the variations of color and grain. Shadings of white, red, black, yellow and even green may be visible. Mineral streaks may also add to the distinctive appearance, reflecting the tree's "life history" as it absorbs minerals differently from one area to another. Grain and apparent texture may range from even and consistent to varied and dramatic. These natural variations result in unique character markings on adjacent cabinets, on pairs of doors and even within the same panel. These variations can also appear on edges of hardwood doors where solid lumber cores are exposed in certain styles. These unique characteristics of wood are pointed out to remind you that each piece is different. The varied affect, more clearly evident in the natural finish, may be different in a complete kitchen from that represented by a smaller display or finish sample. Neither we the manufacturer, nor your dealer can be responsible for the type or degree of variations which may actually characterize your cabinetry.

Characteristics of Laminate

Laminate cabinetry features doors and drawer fronts surfaced with laminate PVC. These products also feature face frames constructed of solid wood with a painted finish protected with a catalyzed varnish. Woods naturally expand and contract with changes in temperature and humidity; therefore, some visible cracks may eventually form in the area of cabinet joints. Since the doors and drawer fronts are fabricated with different materials than the solid wood face frames, the natural aging process may cause the two materials to show some color variations. The levels of exposure to sunlight, smoke and household chemicals will all have an impact on the color variation.

The preceding is not a warranty. If you have specific warranty questions, contact the manufacturer's customer service for warranty information and limitations.