

24-IN WALL CABINET 2 DOORS

CAISSON DE HAUT 24-PO. 2 PORTES



Assembly Instructions
Instructions d'assemblage



Z00200



x16

Z00210

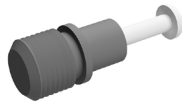

x8

Z00209



x8

Z01561



x4

Z01558



x4

Z01361



x8

Z01362



x4

Z00200



x16

CQ-CHIG-BL



x2

CQ-D2430-FBL

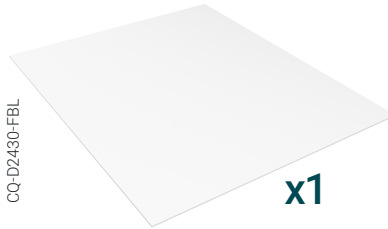

x1

CQ-BH24-BL



x2

CQ-DD24-BL



x2

CQ-TH24-BL



x2

Door models

Modèles de portes

CQ1230-MEL-BL

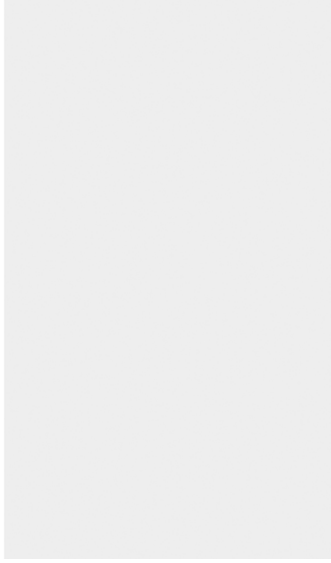

CQ1230-ST-BLM



CQ1230-ST-GRM



CQ1230-MEL-FEY



CQ1230-PA-NOM

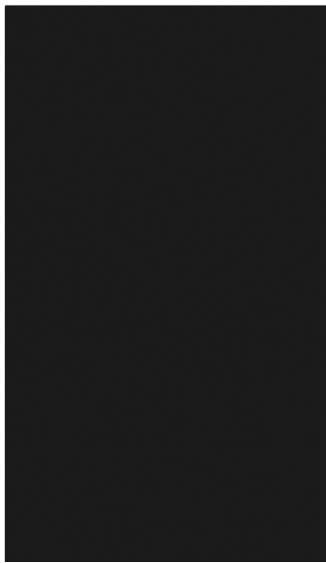

1

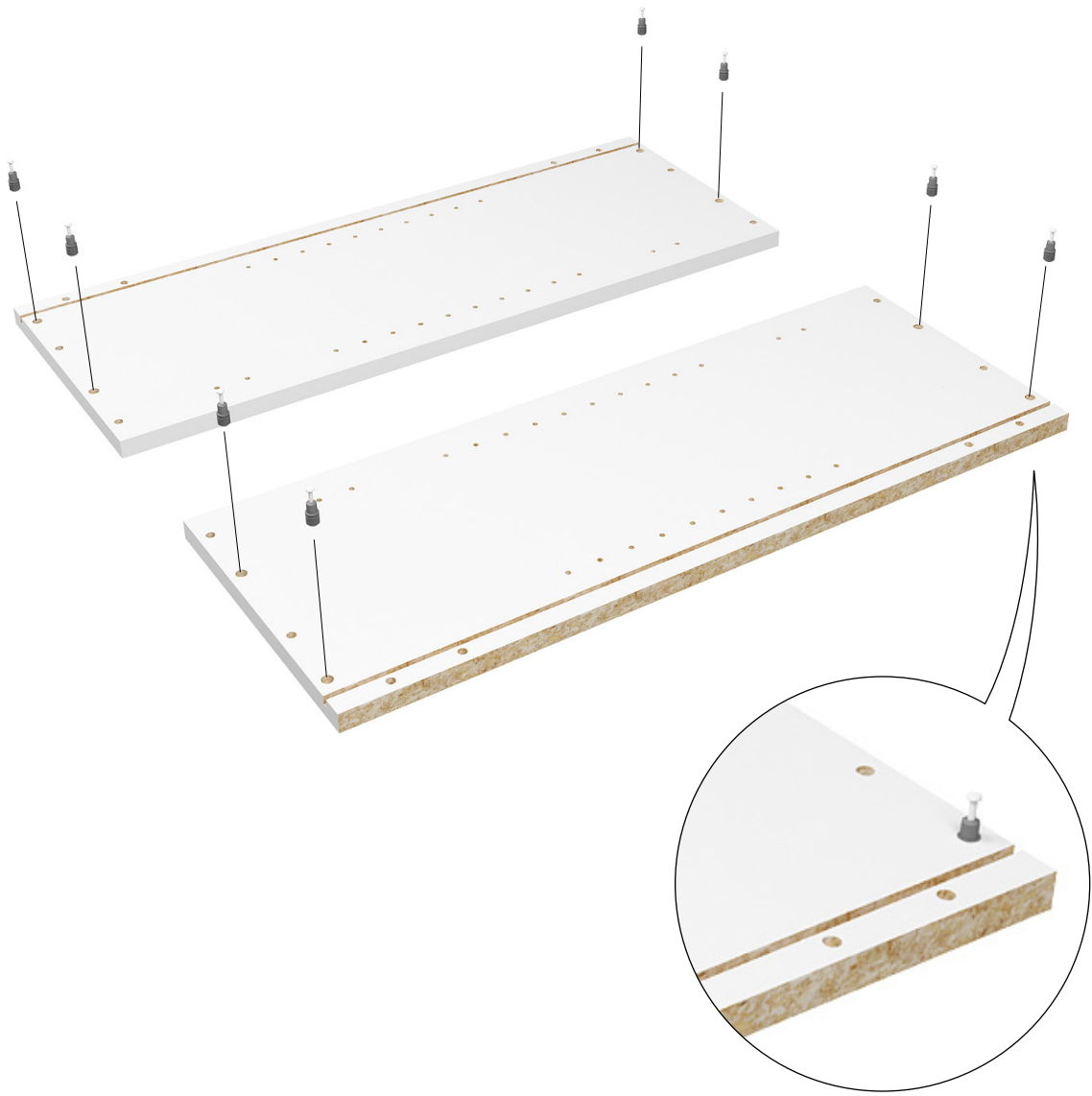
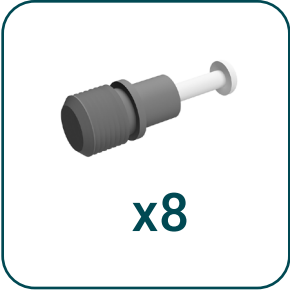
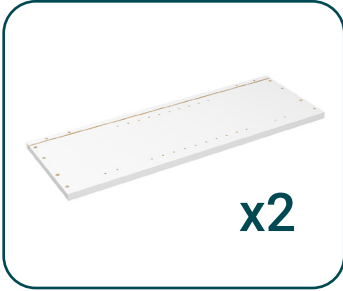

2

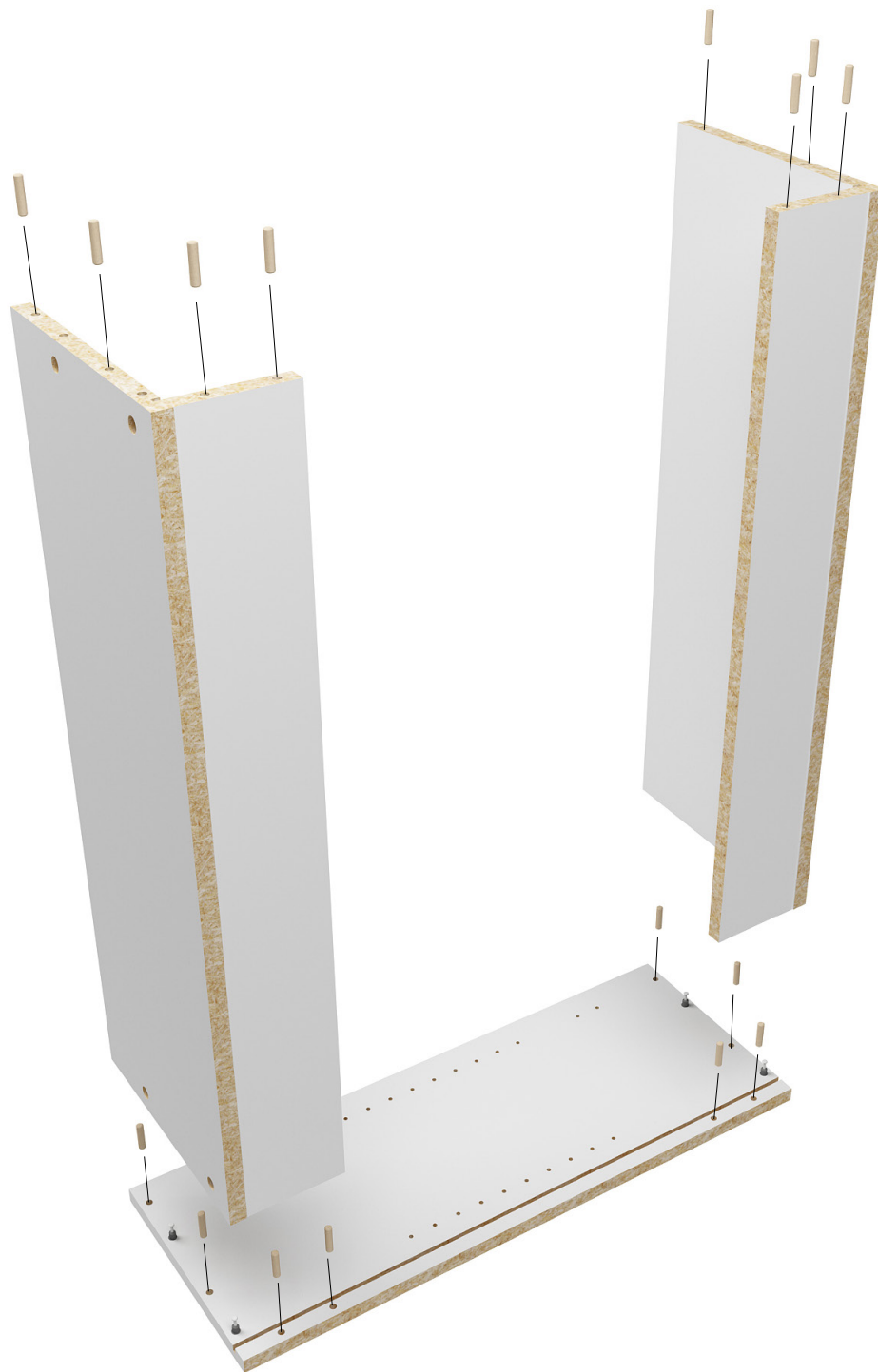
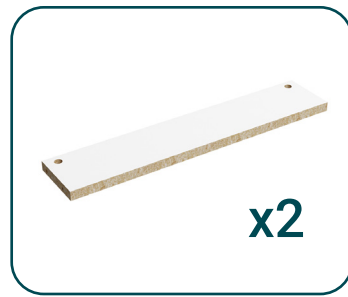
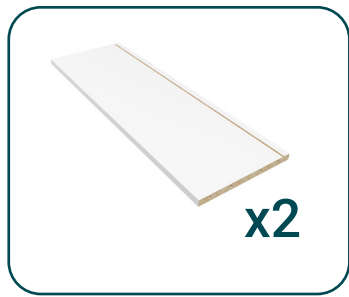

3

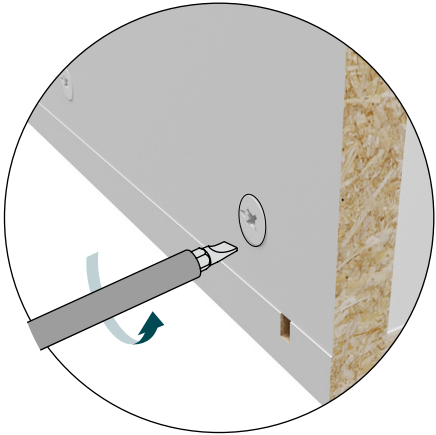
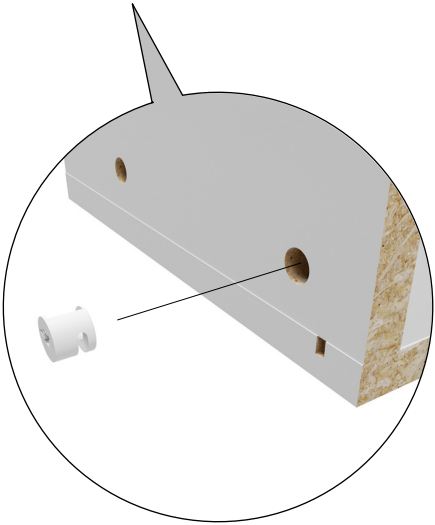
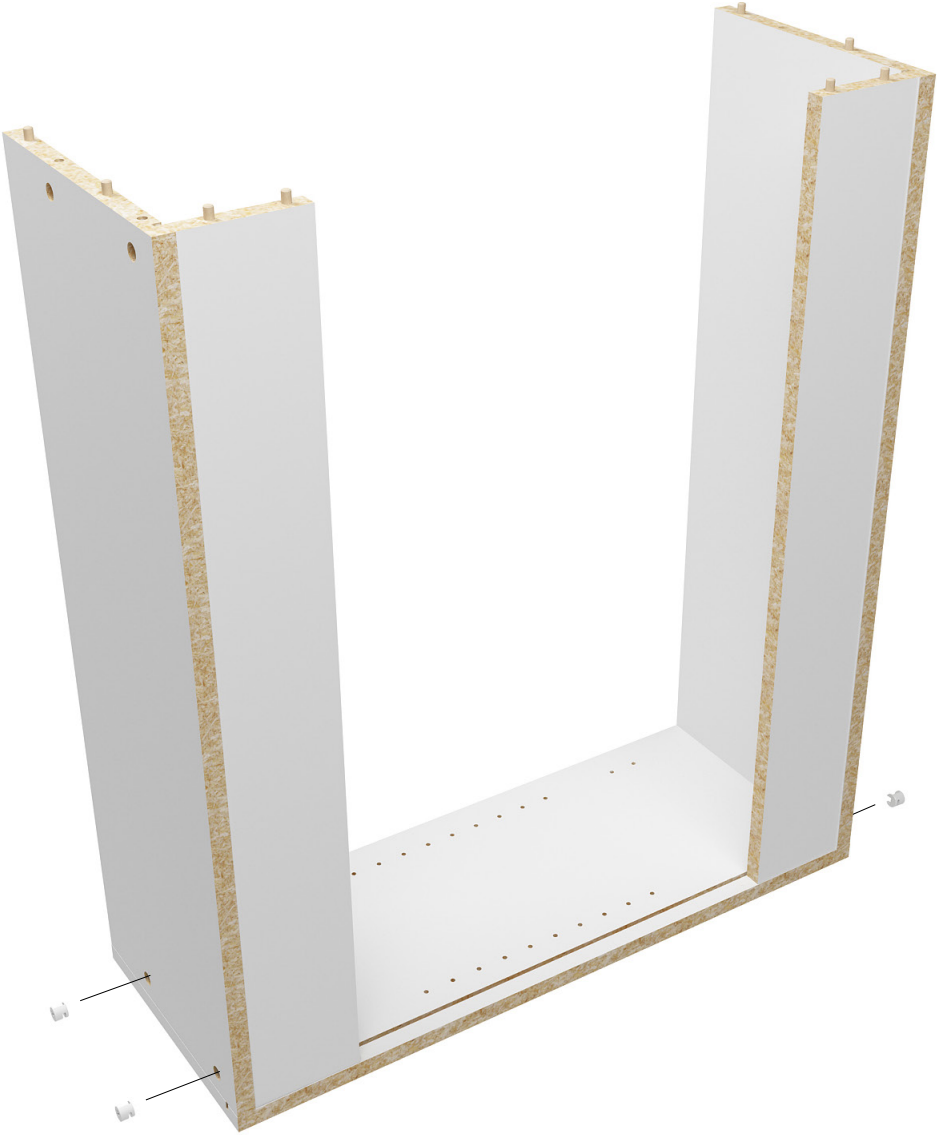
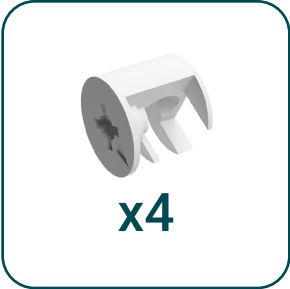

4

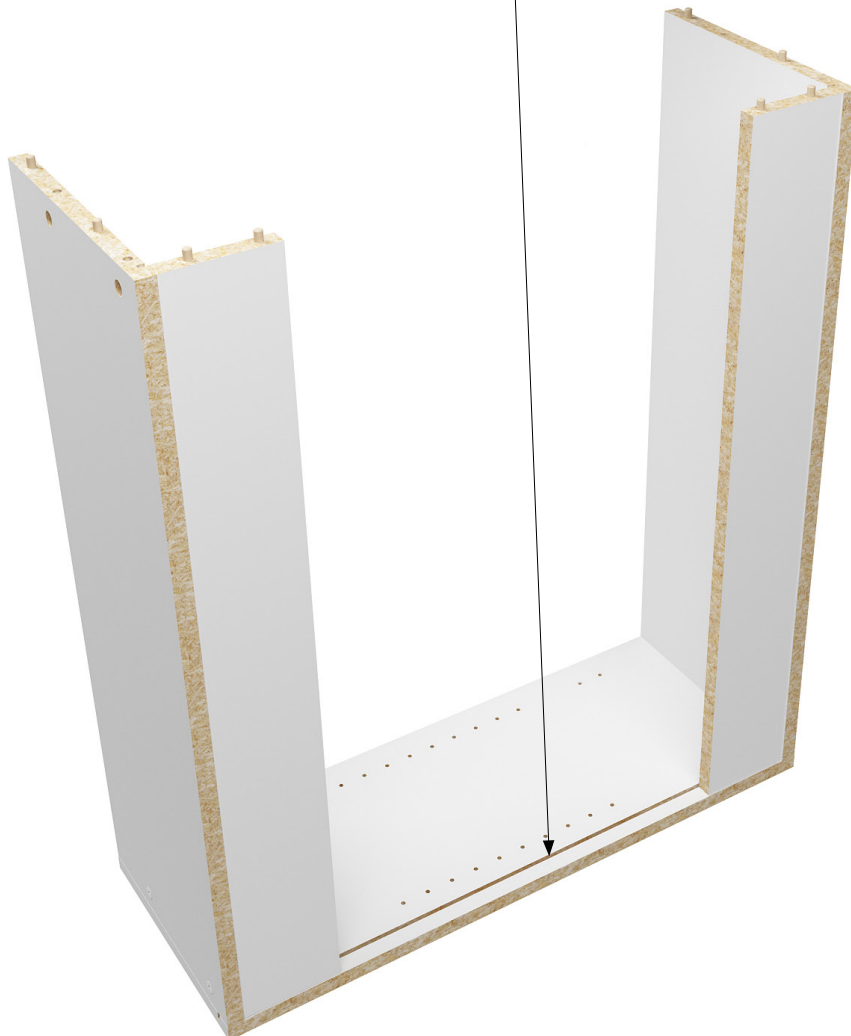
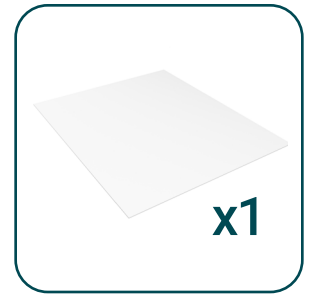

5

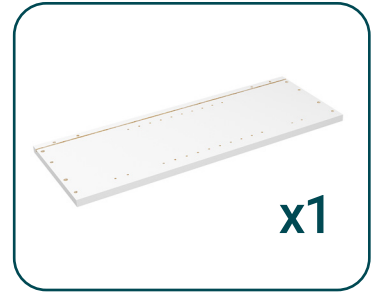

6

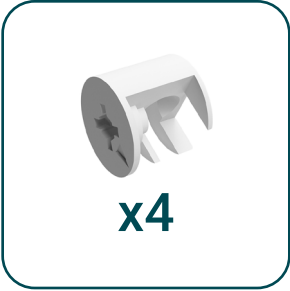

7

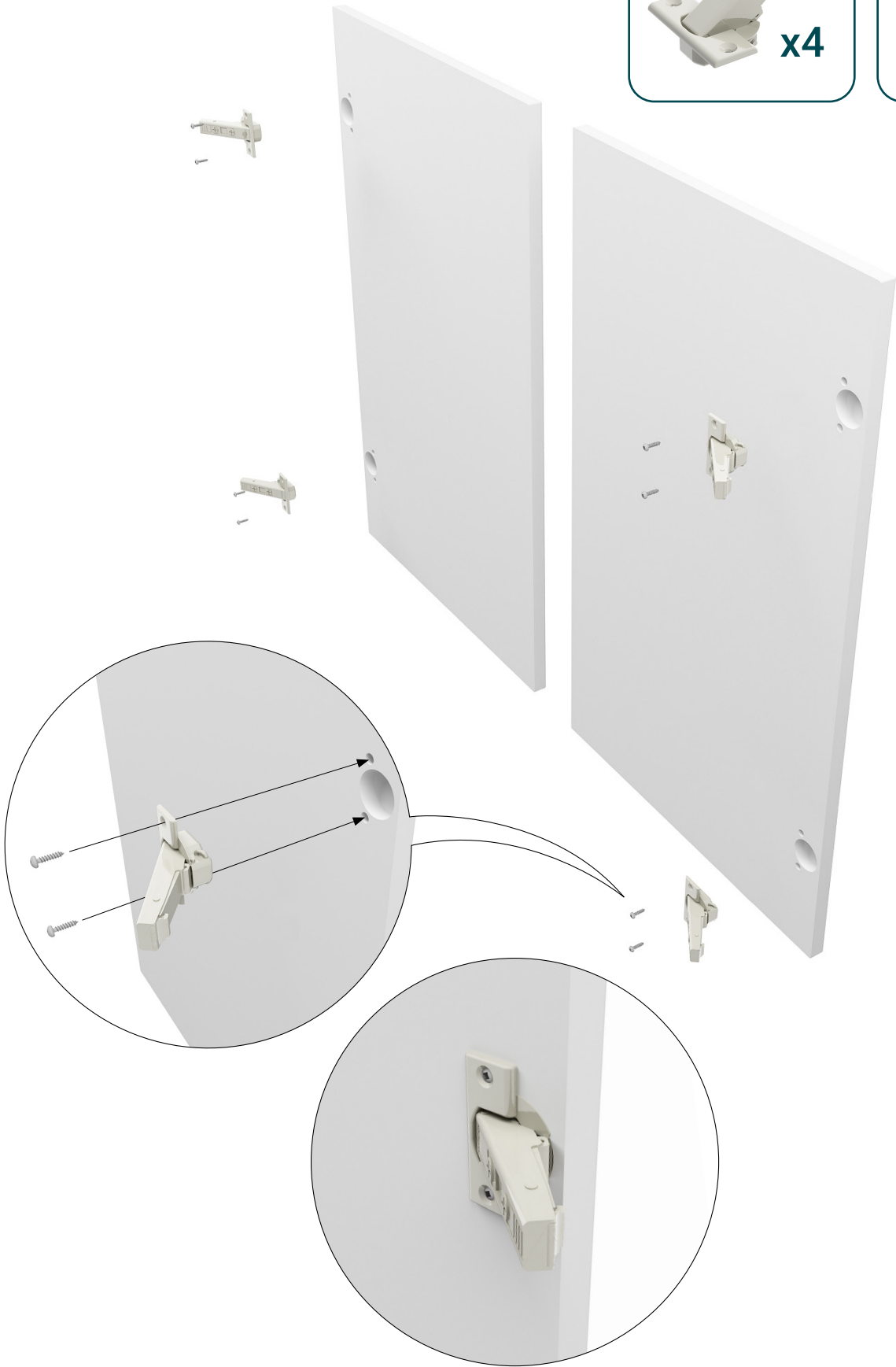
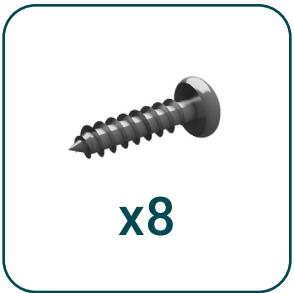

8

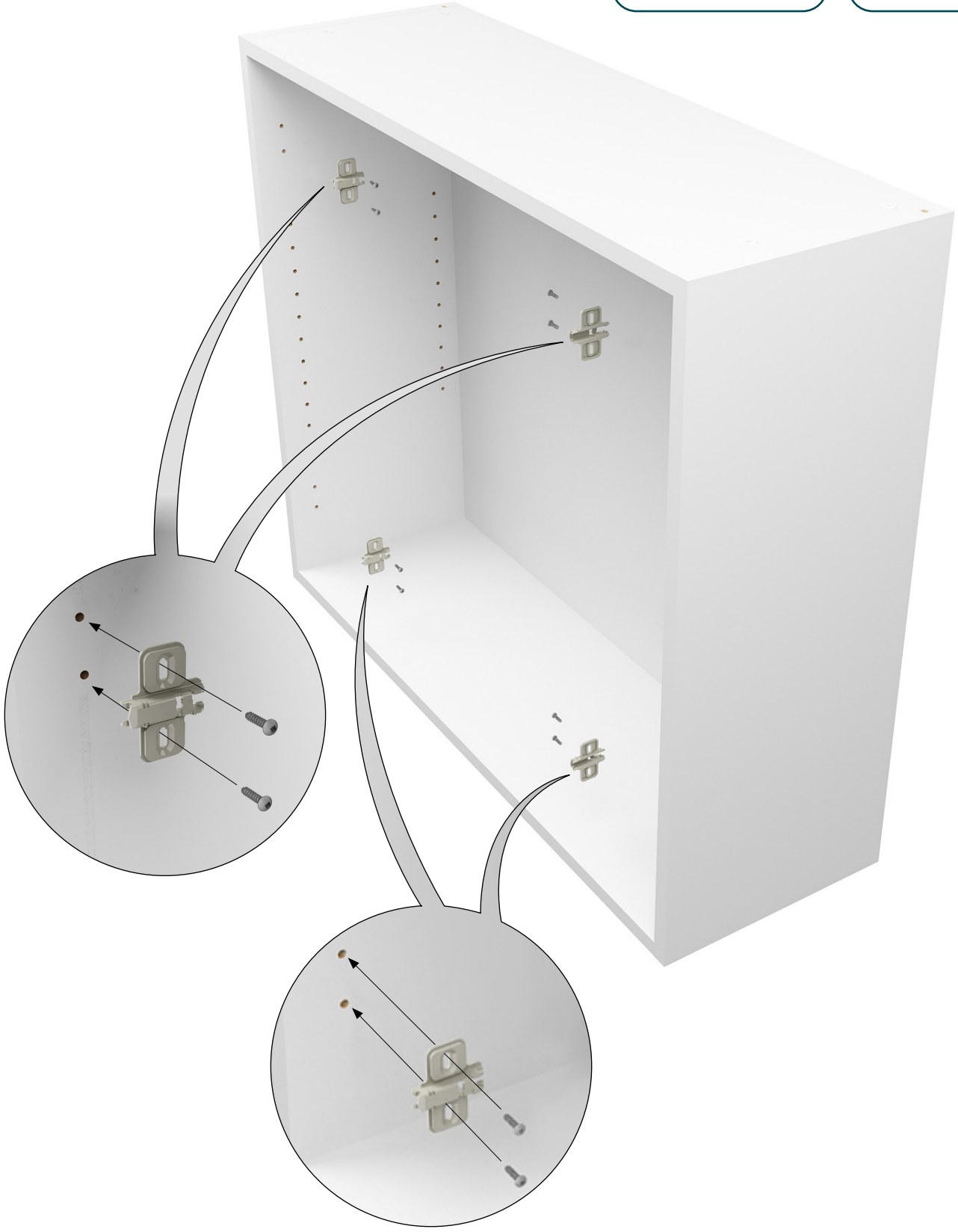
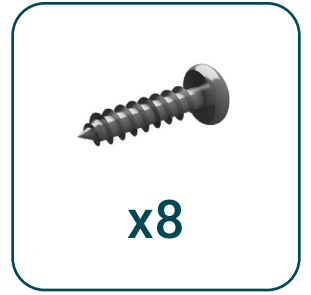

9



10

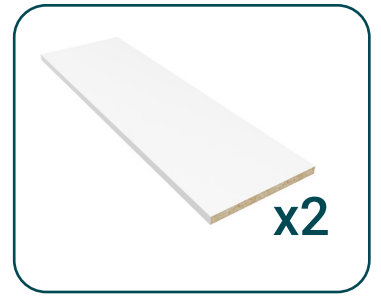

11



12



CONTACT US
CONTACTEZ-NOUS
EKLIPSE@EBSU.CA
1 877-533-7729

