

# INSTRUCTION MANUAL

Model: A29



## ATTENTION

Thank you very much for your purchase.

When the number of your order is more than 1, we will split your order and ship the goods separately to ensure the safety.



Scan the code to watch the  
installation video.

# PARTS LIST

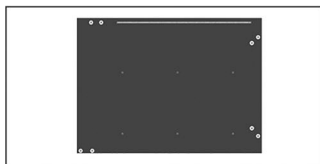

① X1 Right side panel

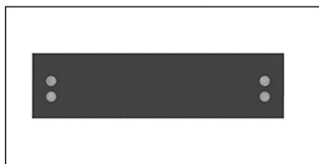

② X1 Rear decorative panel

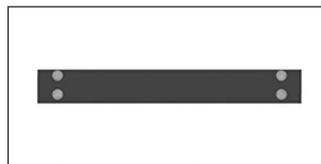

③ X1 Front decorative panel

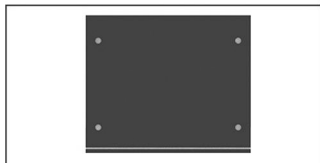

④ X1 Middle trim panel



⑤ X1 Back panel-1

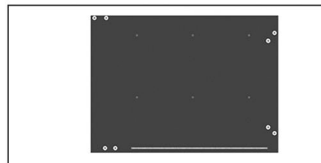

⑥ X1 Left side panel



⑦ X2 PC panel



⑧ X3 Drawer left-1

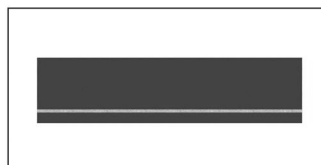

⑨ X3 Drawer back-1

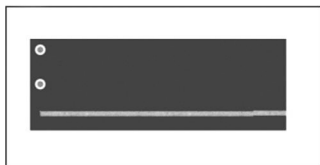

⑩ X3 Drawer right-1



⑪ X3 Drawer bottom-1



⑫ X3 Drawer front-1



⑬ X1 Right trim panel



⑭ X1 Back panel-2



⑮ X1 Left trim panel



⑯ X1 Top panel

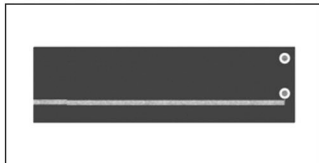

⑰ X1 Drawer left-2



⑱ X1 Drawer back-2

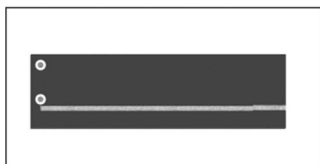

⑲ X1 Drawer right-2



⑳ X1 Drawer bottom-2

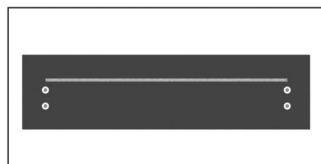

㉑ X1 Drawer front-2

# HARDWARE LIST



**A** 56 PCS

Cam Bolt



**B** 56 PCS

Cam Lock



**C** 38 pcs

Screw-2 14mm



**D** 4 SET 16PCS

Slide rail 250mm



**E** 8 PCS

Screw-1 16mm

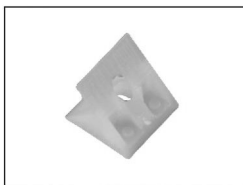

**F** 6 pcs

Rear panel hook

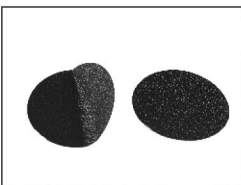

1 SET

Hole cover

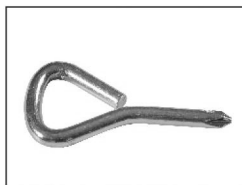

1 PCS

Screw driver



LED\*1 SET

Light strip



1 PCS

Tool hammer



## ATTENTION

- 1.Please place the product on the carpet or carton to assemble to avoid scratching the floor;
- 2.During the installation process,keep away from children and pets,and avoid accidentally swallowing spare parts;
- 3.It is recommended to use a low-speed electric drill for installation.

# step 1.

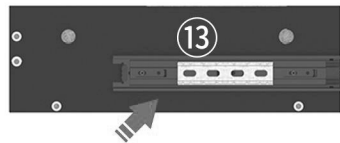
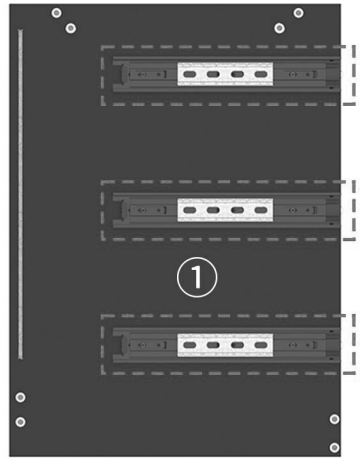
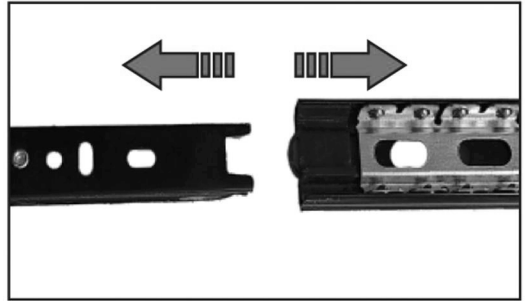
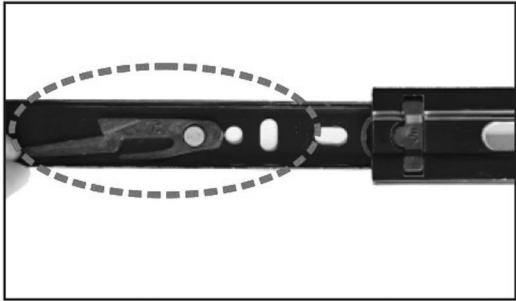

Please check the direction of each slide first!  
Please carefully review the red markings on the slide rails in the manual!

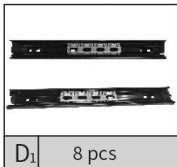

## step 2.

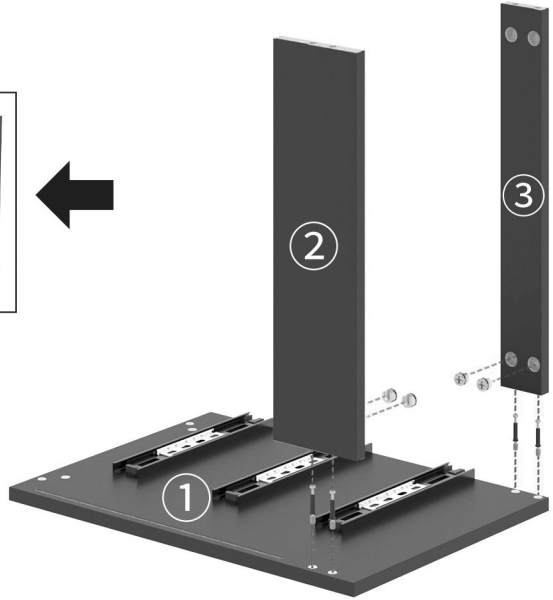

(Attention: Cam bolt & Insert nut need to be put together)



A 4 pcs



B 4 pcs

## step 3.



A 2 pcs



B 2 pcs

## step 4.



## step 5.

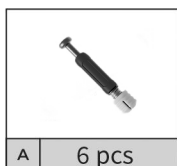

A 6 pcs



B 6 pcs

# step 6.

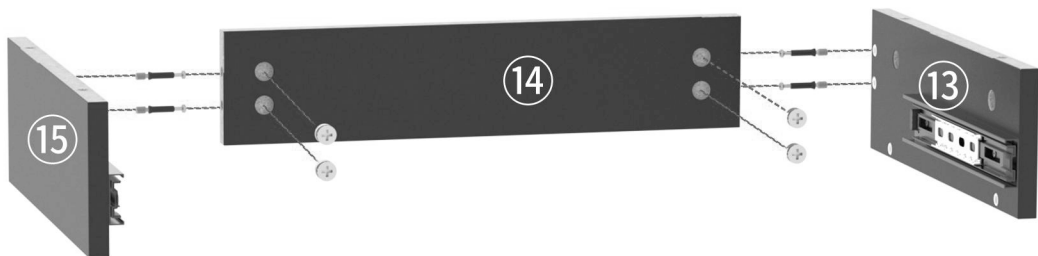

A 4 pcs



B 4 pcs



# step 7.



A 4 pcs



B 4 pcs

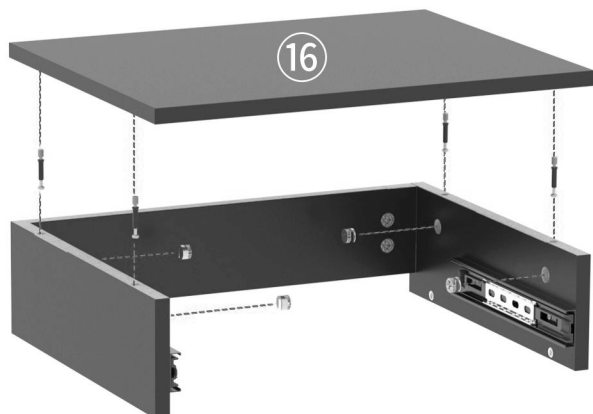

## step 8.

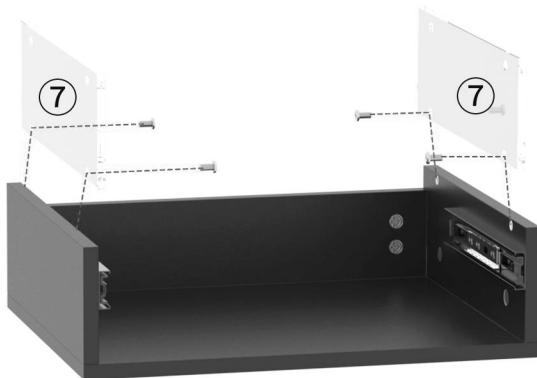

E 4 pcs

## step 9.

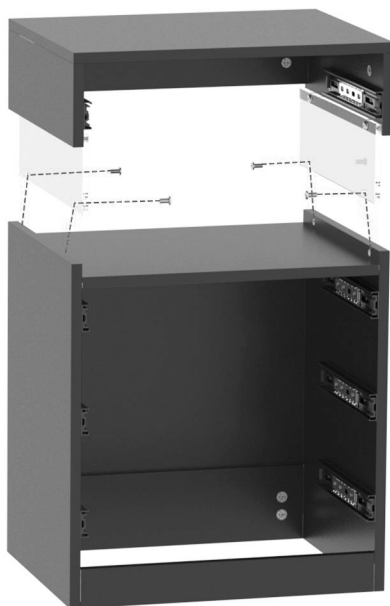

E 4 pcs

# step 10. X4

## DRAWER INSTALLATION

**1** Connect part 8&9to10

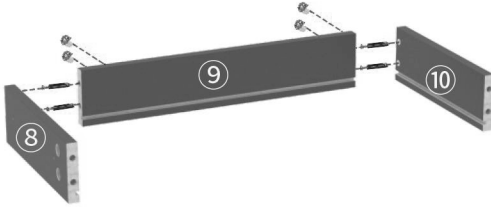

**2** Insert part 11

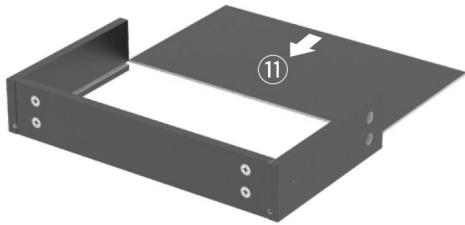

**3** Connect Part 12



**4** Install hardware "D" to part 8 & 10, 17 & 19 according to the pre-drilled holes



Top 1 drawer

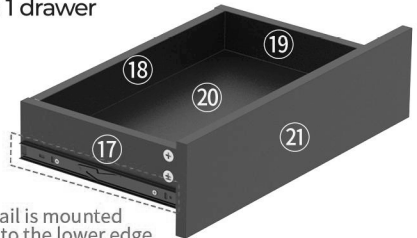

This rail is mounted close to the lower edge

Bottom 3 drawers

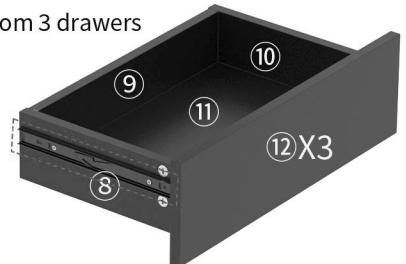

A 16 pcs



B 16 pcs



C 16 pcs



D<sub>2</sub> 8 pcs

## step 11.

Stick the light strip inside the back panel for testing.

You can choose to paste it from left to right or from right to left.

Note: If the light strip is not pasted correctly, it should be gently removed and avoid using too much force to prevent the lightstrip from breaking. If the light strip is not on or damaged, please contact the online seller in a timely manner.

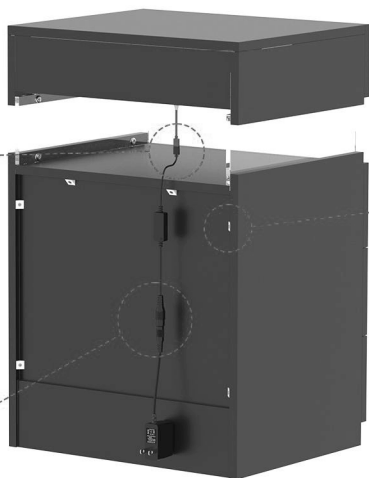
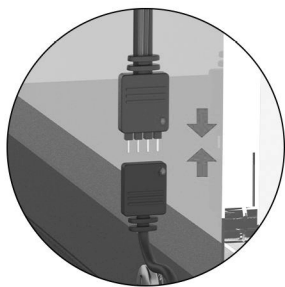
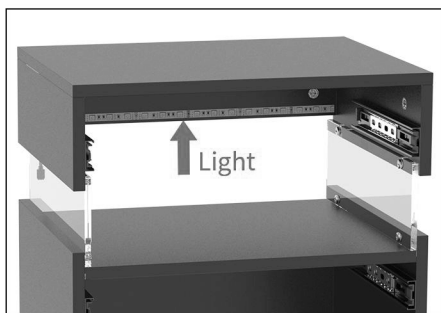
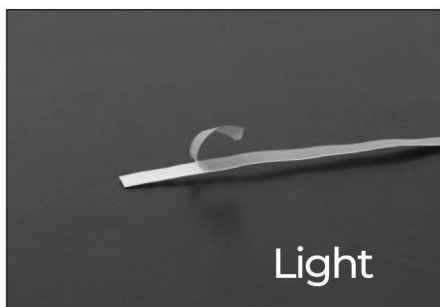

As the picture shows.

Fix hardware "E" into the gap with screws to make the back panel more stable.

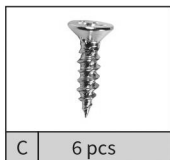
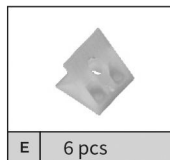
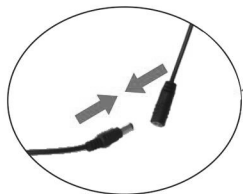

## step 12.

Please stick the hardware "Holecover" on the exposed cam lock hole that makes your product more beautiful.

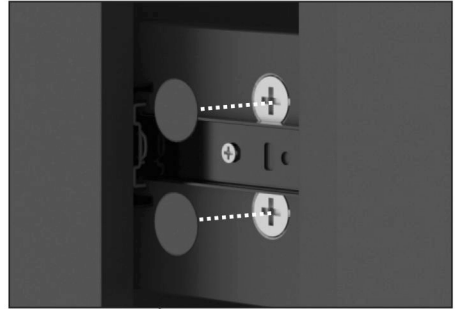
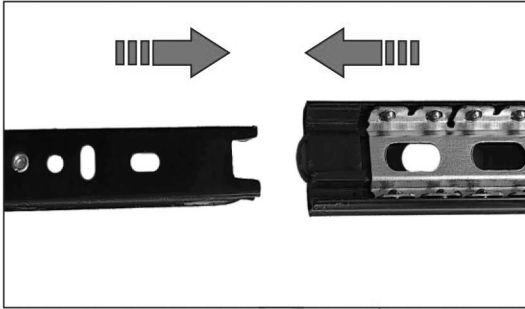



**Congratulations on successful installation!!!**

**THANK YOU VERY MUCH FOR YOUR PURCHASE.**