

MANUAL INSTRUCTION

METAL GARDEN SHED

IS407BR01

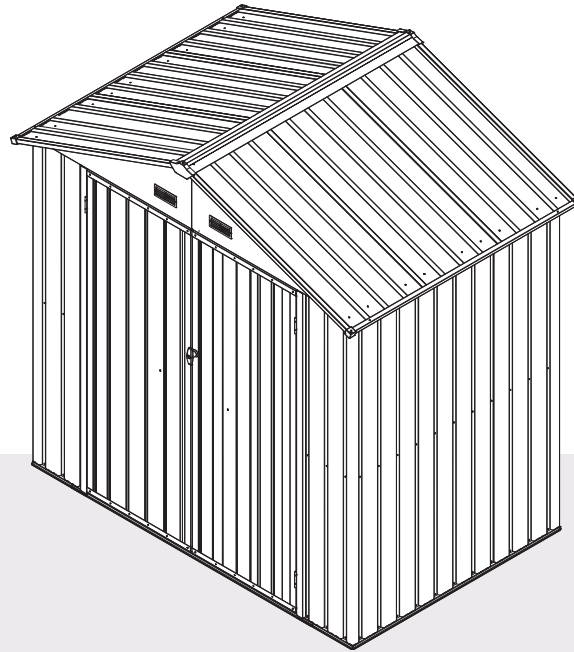
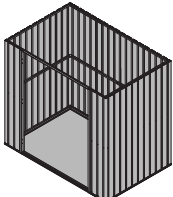
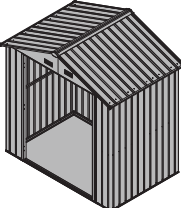
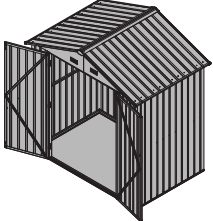

part 1: Precautions and preparations	3-6
part 2: Material list (please check before installation)	7-13
part 3: Cabinet installation	14-35
	
part 4: Roof installation and internal fixing	36-47
	
part 5: Door installation and adjustment	48-57
	
part 6: Help center	58

Outdoor Furniture

We are a professional furniture provider with top-notch factories and outstanding designs, Our mission is to provide consumers with new lifestyles. By collecting consumer feedback, we constantly improve our products and create more choices for consumers. If you want to create your space, We are an ideal choice.

Always.



WARNING

- 1. Two or more people are required for assembly.**
- 2. A ladder and electric drill may be necessary.**
- 3. Do not erect the structure in heavy winds or inclement weather.**
- 4. It is a temporary, portable shelter that shields you from sunlight and rain. The screens also block flying insects.**
- 5. Do not use candles, matches, or any open flames near the tent.**
- 6. To better align the screws for practical situations, do not fully tighten screws initially.**
- 7. Professional installation is highly recommended.**

WARNING

- In case of windy weather, please do not stand in the gazebo.
- Please do not stand under the gazebo in case of heavy snowfall.
- For safety, please use expansion screws to reinforce the posts to the ground.
- In windy weather, please tighten the fence and netting to avoid tearing in high winds.
- In extreme weather conditions, you can use a rope to pull the four corners of the gazebo to keep it stable.
- Please clear the snow off the roof in time for the heavy snowfall.
- Make sure all screws are tightened before use.
- Repeat to confirm all screws, buckles and straps every 90 days.
- Please keep all screws loose during the assembly process and tighten them after completing the installation.
- Do not use or store next to a pole with an open flame or flammable chemicals.
- Please note that some parts have sharp edges and should be handled with gloves.
- If any parts are missing, broken, damaged or worn, discontinue use of the product until repairs are made or factory replacement parts are installed.
- Installation of the product in a manner that does not conform to the manufacturer's instructions may result in the loss of the warranty policy for this product.
- Consult your local authorities to check if permits are required to erect the shed .

WARNING

WARNING: This product can expose you to Carbon monoxide, which is known to the State of California to cause birth defects or other reproductive harm. For more information go to www.P65Warnings.ca.gov

TOOLS REQUIRED

EQUIPMENT REQUIREED(Not included in boxes)

*NOTE:Tools / equipment are not shown to actual size and scale.



LEVEL



RUBBER Mallet



PHILLIPS SCREW



DRILL



ALLEN KEY

EQUIPMENT REQUIREED(Not included in boxes)

*NOTE:Equipment are not shown to actual size and scale.



SAFETY HAT



GLOVES



SAFETY GOGGLES



STEPLADDER
(6.5Ft Or More)

Matters needing attention



Three or more people
are required for
assemblie



Do not fully tighten
screws prior to complete
assembly

INSTALLATION PRECAUTIONS

Right

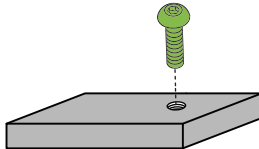

Wrong

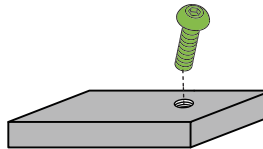

*The screws need to be aligned with the hole when installing.

*If the screw cannot be tightened ,please do not tight forcely ,as this may cause damage to the threaded hole.The correct way is to withdraw the screw and adjust to the right angle ,and try to tighten the screw again.

Part 2: Material list

As this item contains many parts, please read the installation instruction carefully before installation . Please use tools properly and carefully. If you have any questions about the product and installation, please contact us.





(please check before installation)

Hardware list

<input checked="" type="checkbox"/>	
<input checked="" type="checkbox"/>	
<input type="checkbox"/>	
<input type="checkbox"/>	

P8

Parts list

<input checked="" type="checkbox"/>	
<input checked="" type="checkbox"/>	
<input type="checkbox"/>	
<input type="checkbox"/>	

P9-P12

HARDWARE

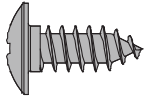

F1 X 300



F2 X 25

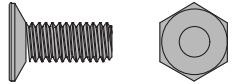

F3 X 12

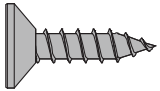

F4 X 12



S2 X 30



S3 X 285

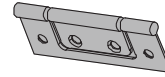

G4 X 6

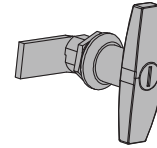

B1 X 1

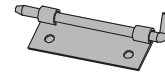

BL X 1

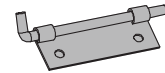

BR X 1



1105mm
X1 X 3



1105mm
X2 X 1

HARDWARE



1105mm

Y1 X 2



1105mm

Y2 X 4

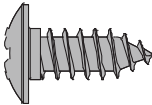

F1 X 34

PARTS

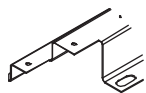

1180mm

1 X 2

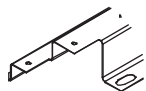

995mm

2L X 1

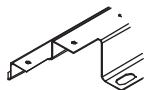

995mm

2R X 1

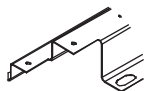

1372mm

3 X 1

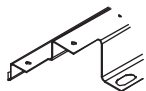

313mm

3L X 1

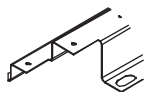

313mm

3R X 1



21L X 2

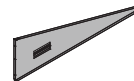

21R X 2



240mm

B3 X 4



239mm

24 X 2



1095mm

22 X 2









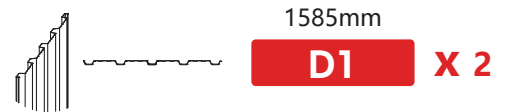
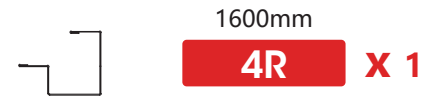

898mm

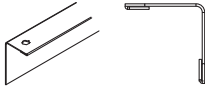
23L X 1

PARTS

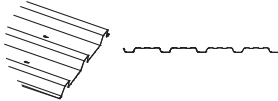

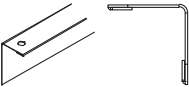
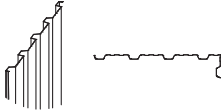
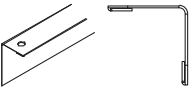
PARTS

	1585mm 40 X 2		1304mm 15 X 2
	1585mm 41 X 1		1014mm P5 X 2
	1585mm 42 X 1		1014mm P6 X 2
	590mm 43 X 4		1014mm P7 X 2
	1014mm 17L X 2		1600mm P9 X 4
	1014mm 17R X 2		1600mm P13 X 2

PARTS

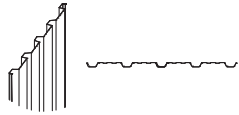

1600mm

P2 X 6

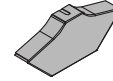

GE X 2

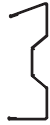

13 X 2



GC X 4



1304mm

19 X 1

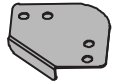

L X 4



DX1 X 4

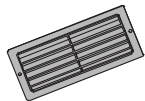

GF X 4

Part 3: Cabinet installation

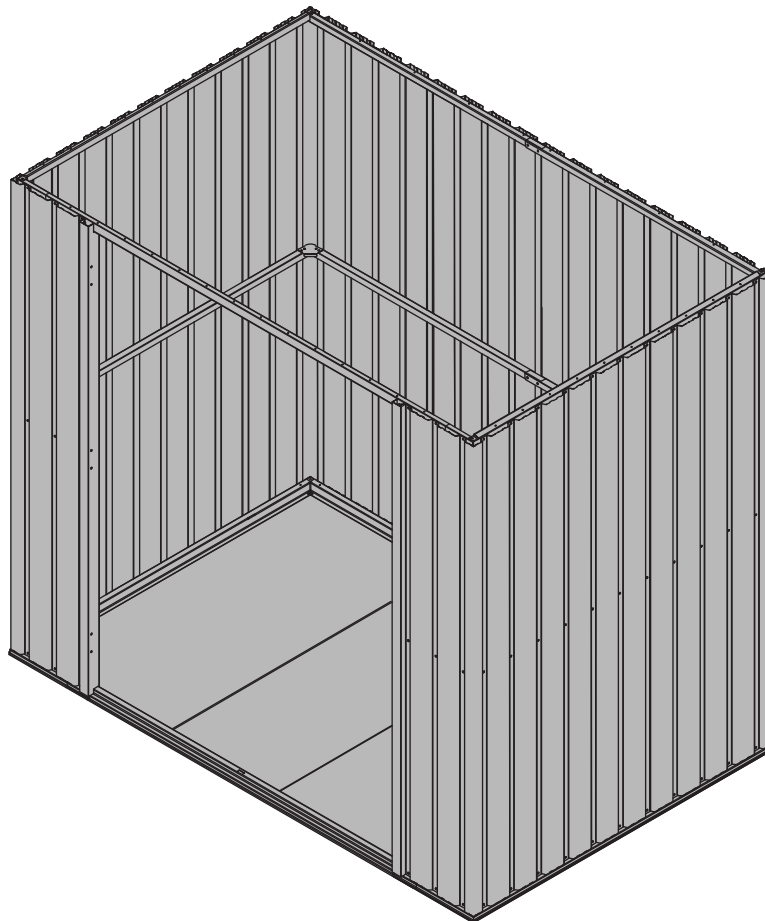

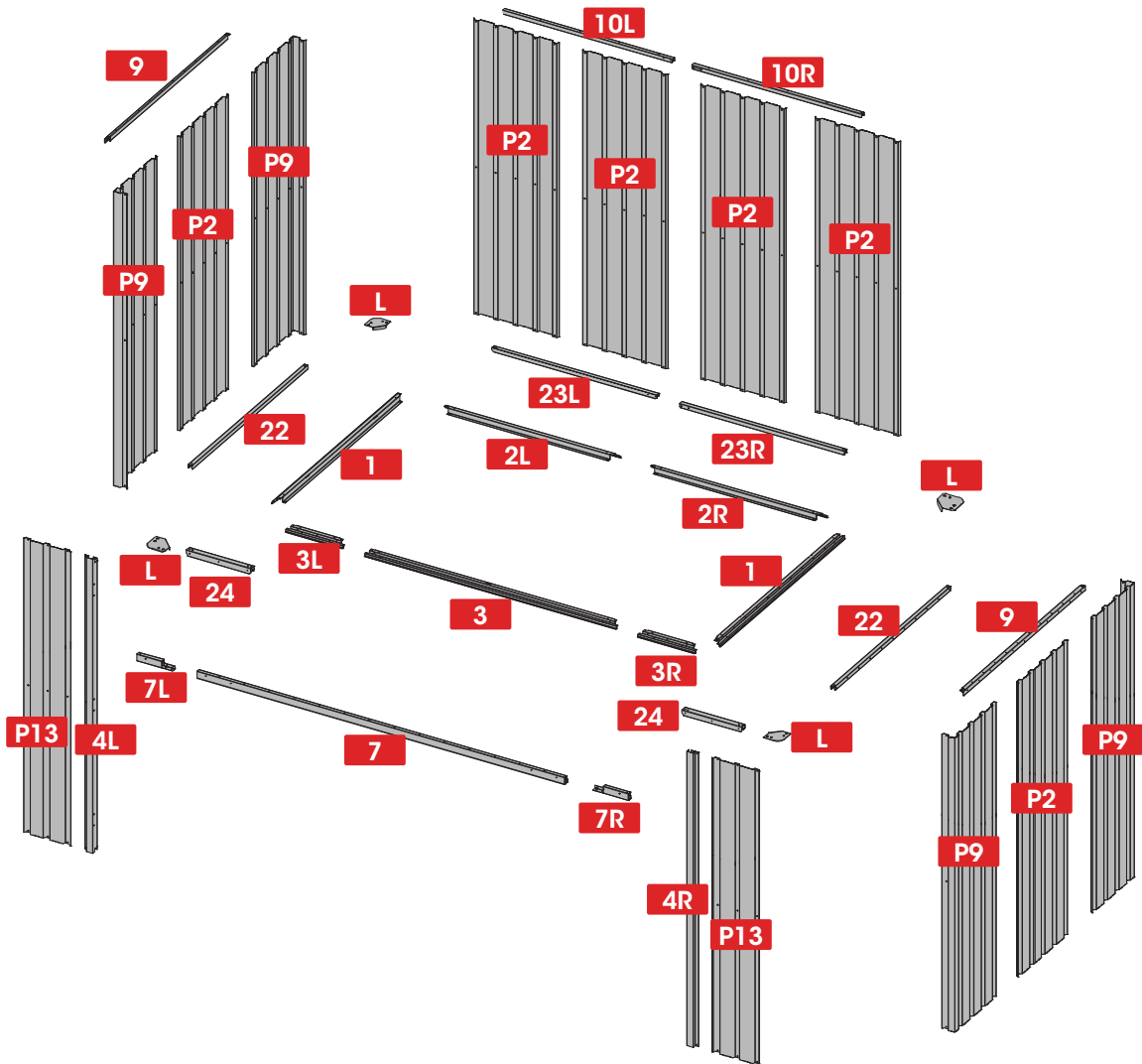

1

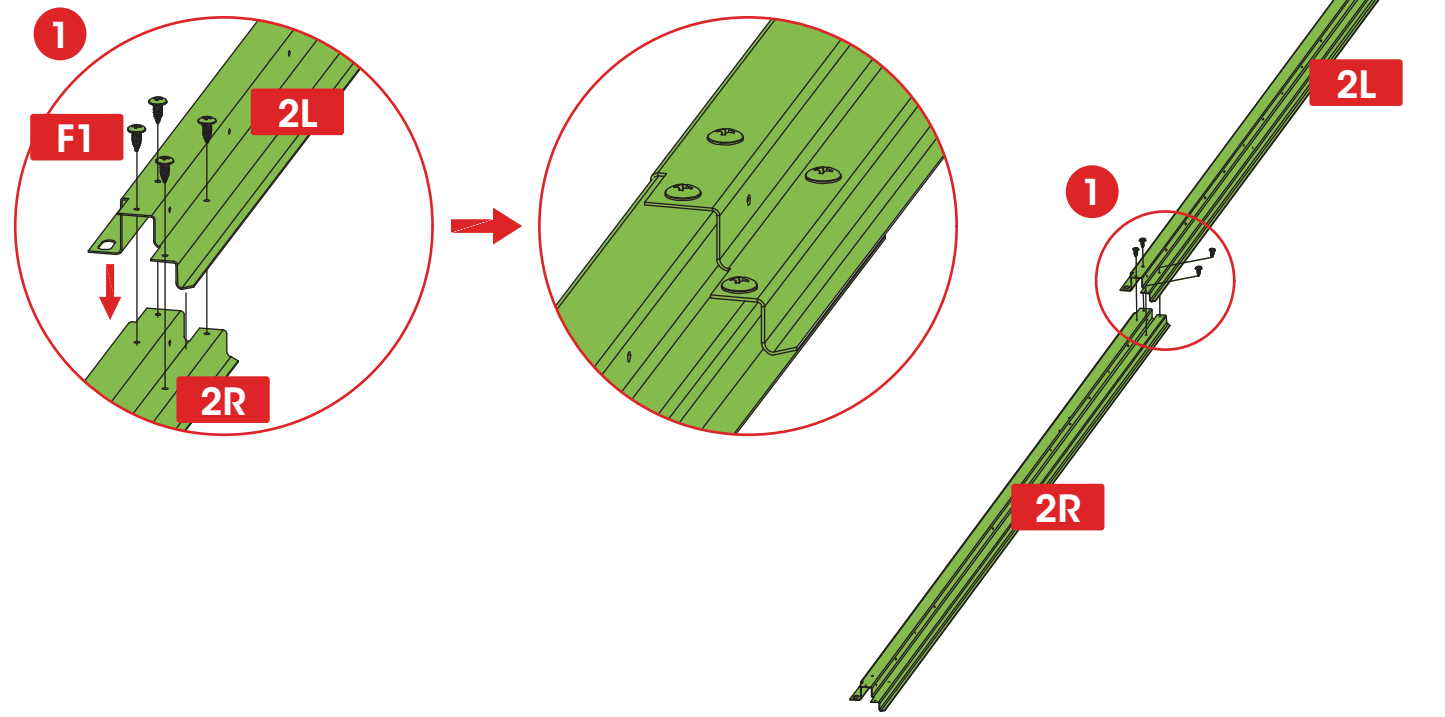

2

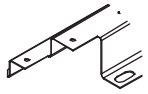
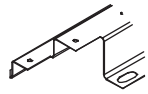
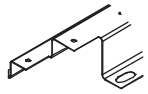
 **3L** X 1  **3R** X 1  **3** X 1

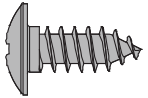
 **F1** X 8

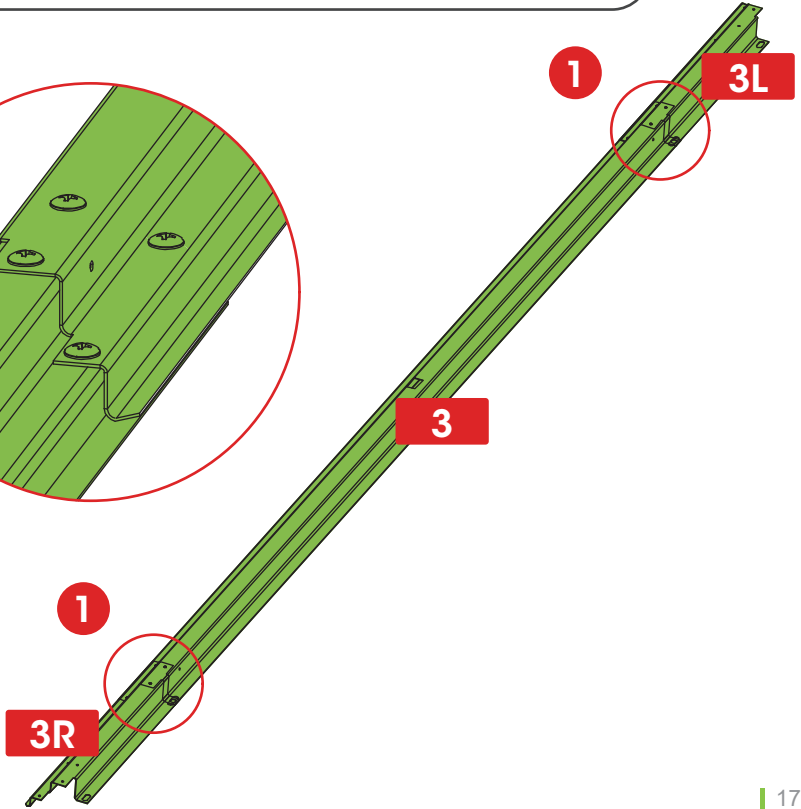
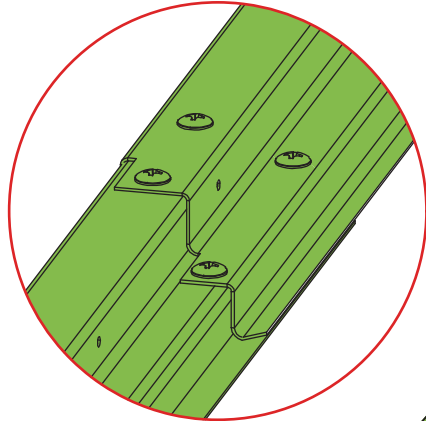
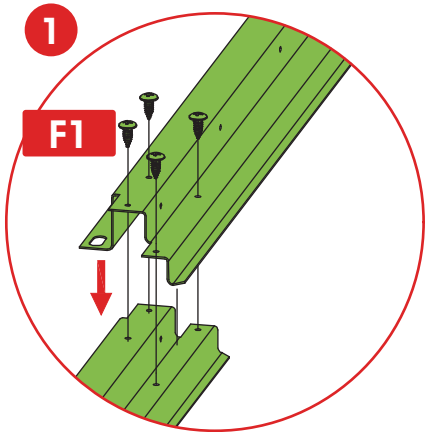

3

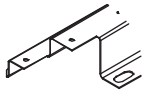

1 X 2

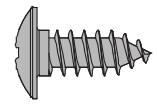

F1 X 8

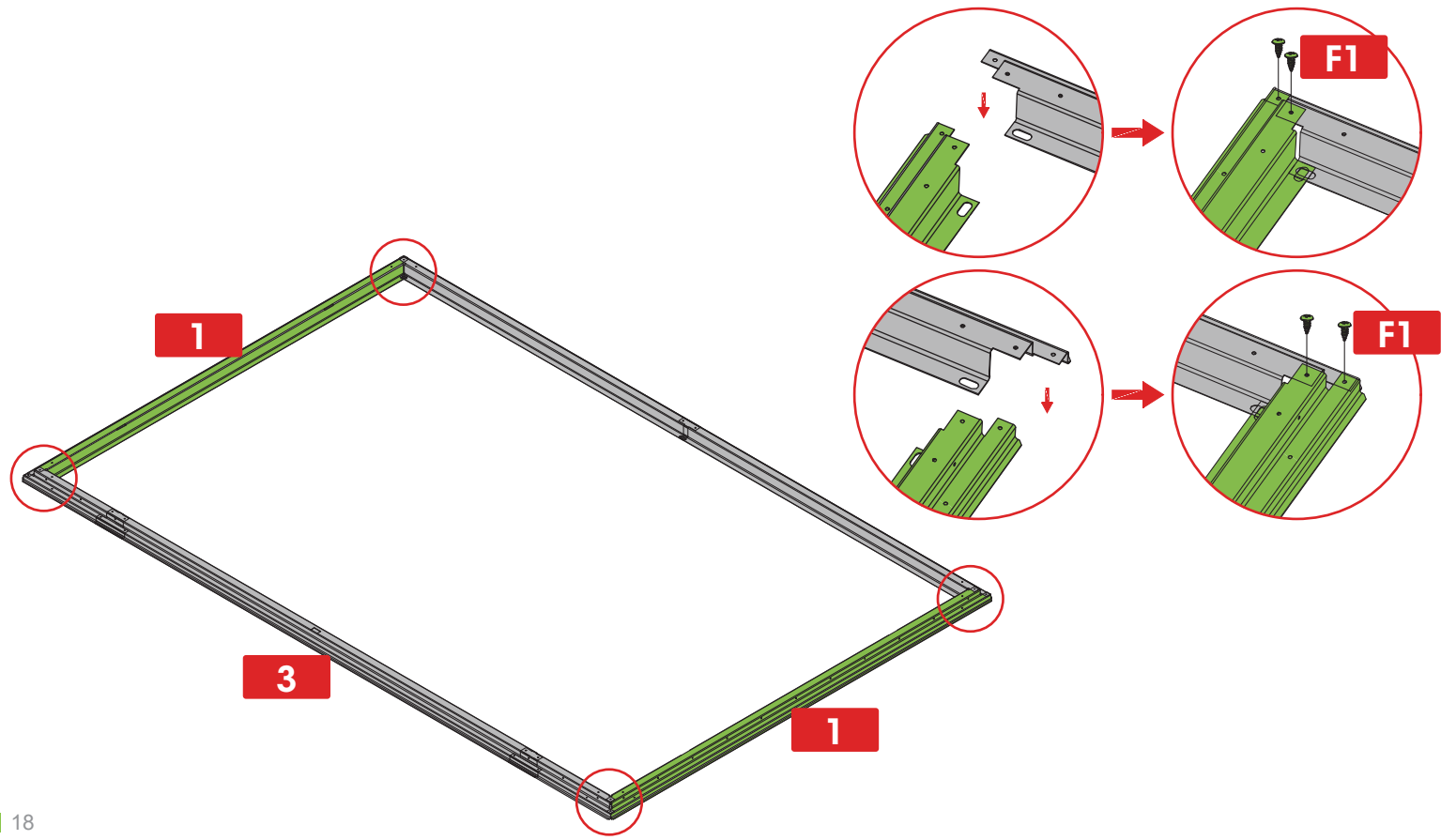

4 1. When diagonal measurements are equal, the frame is square.

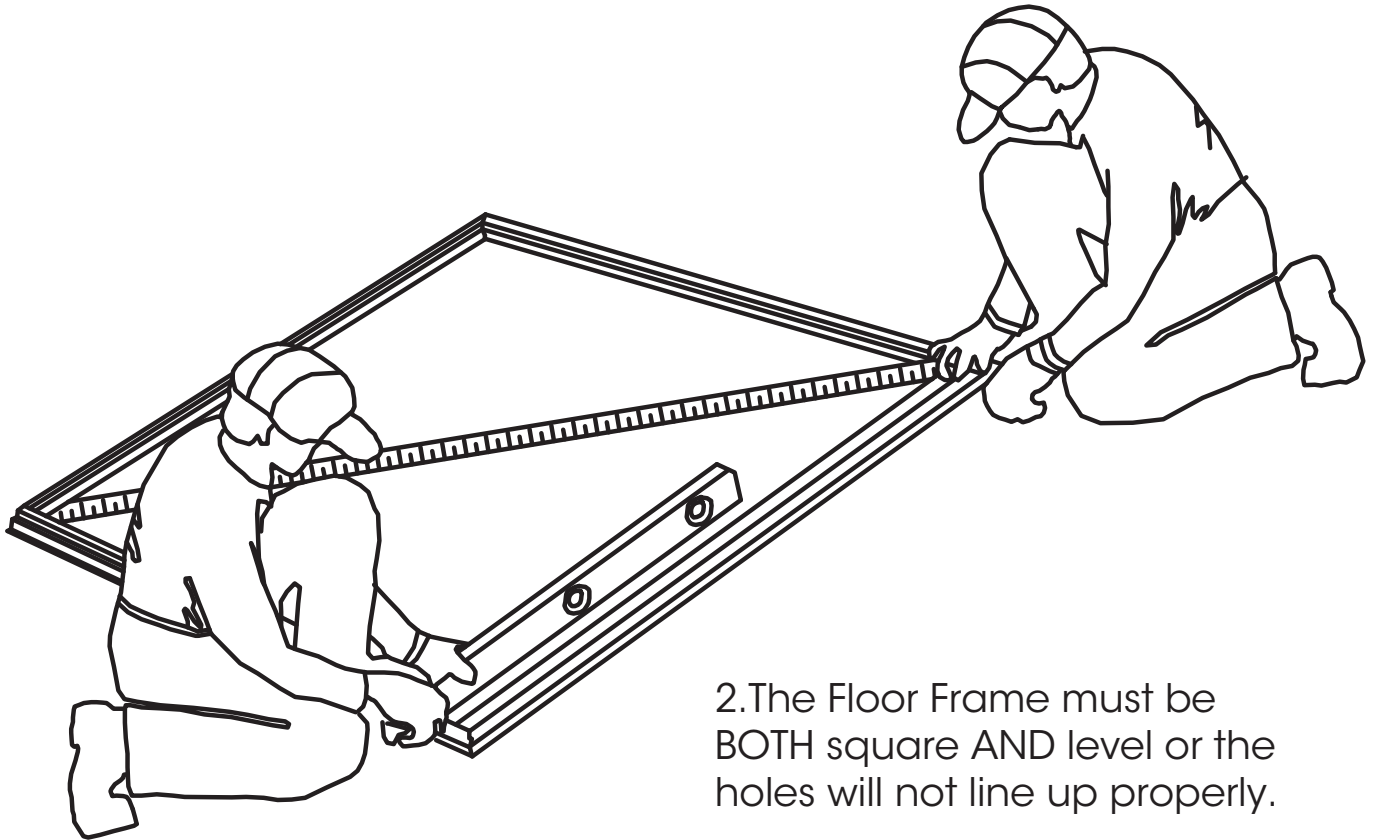



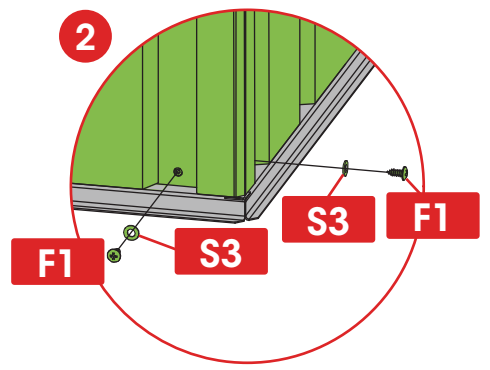
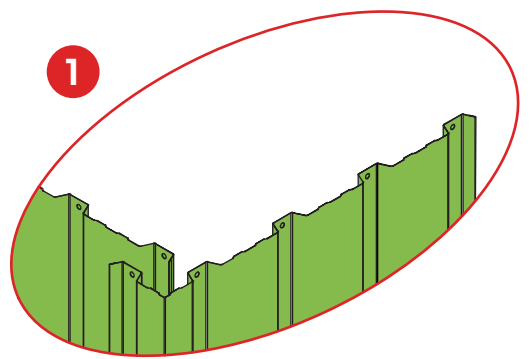
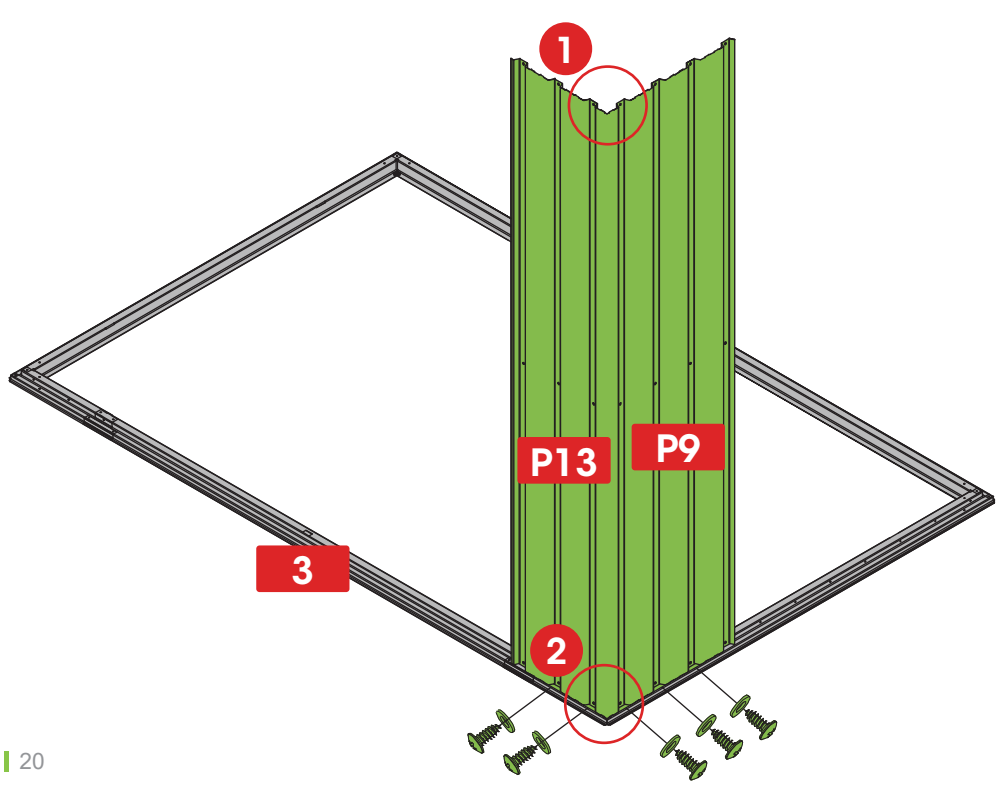

2. The Floor Frame must be BOTH square AND level or the holes will not line up properly.

5

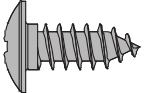

6

	24 X 1		22 X 1		L X 1
	F1 X 9		S3 X 4		

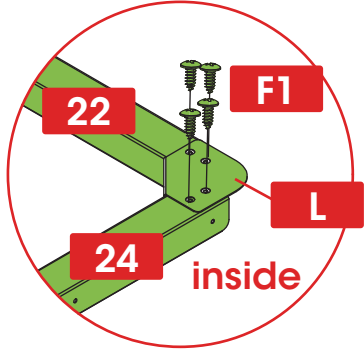
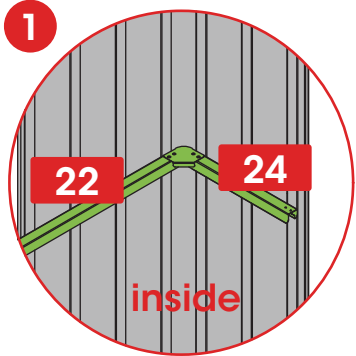
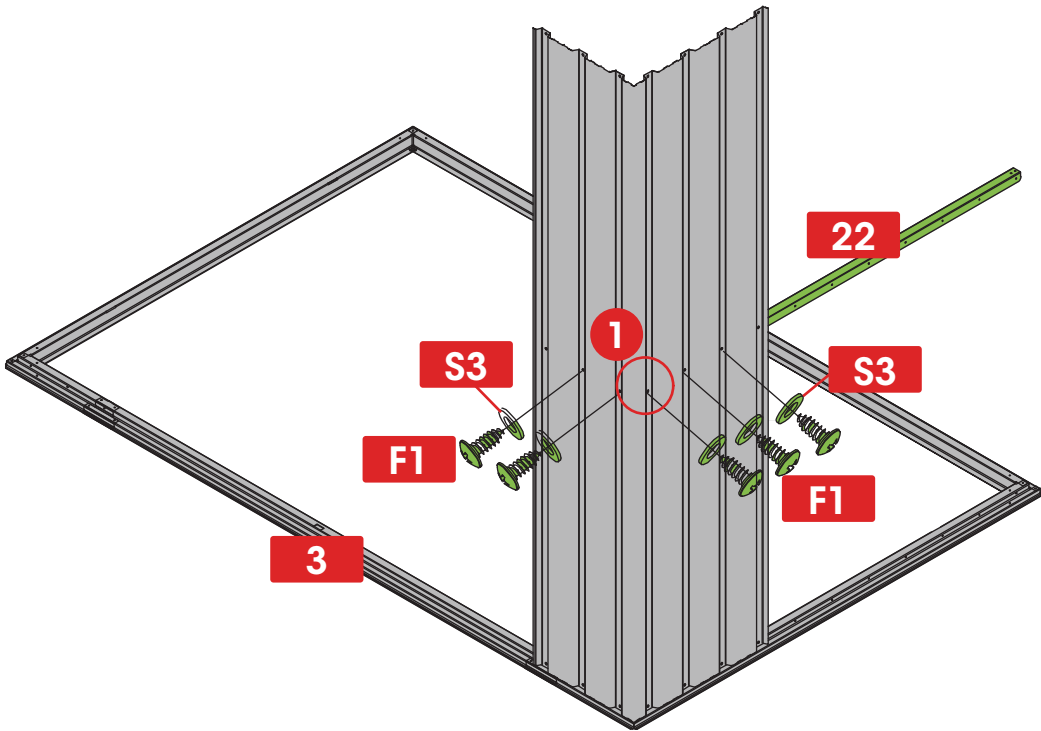

7

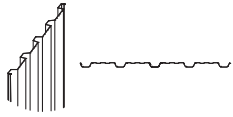

P2 X 1

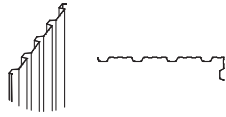

P9 X 1

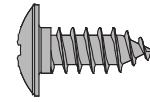

F1 X 10



S3 X 10

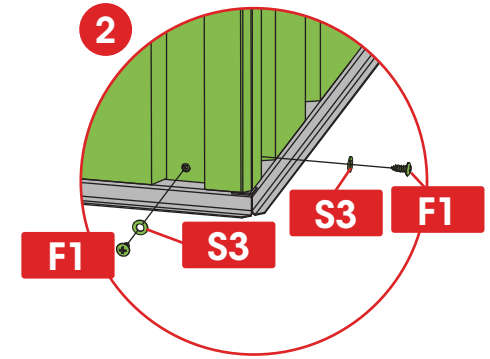
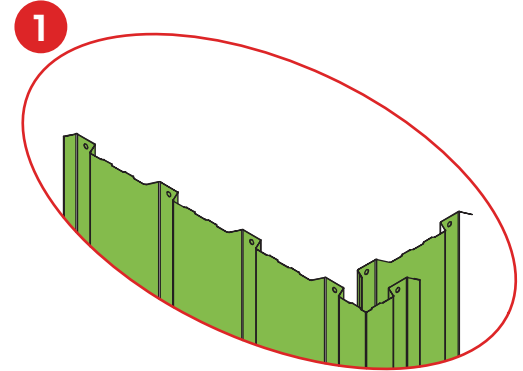
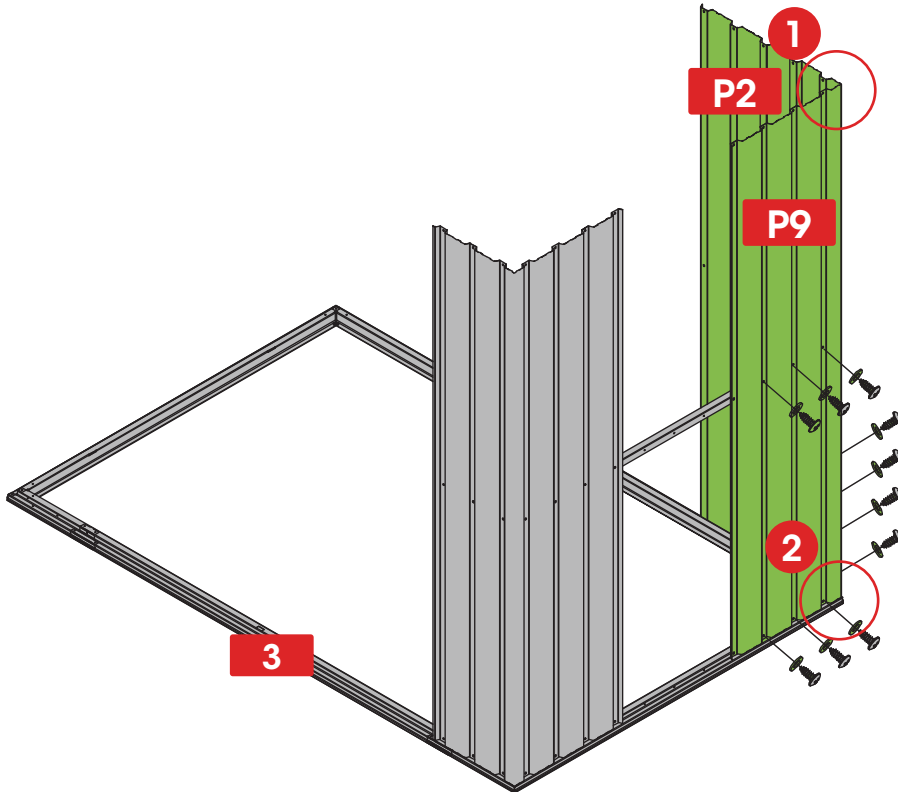

8



23R X 1



L X 1

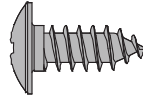

F1 X 8



S3 X 4

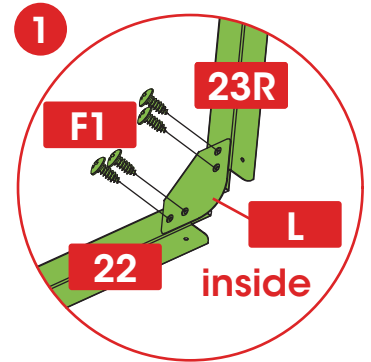
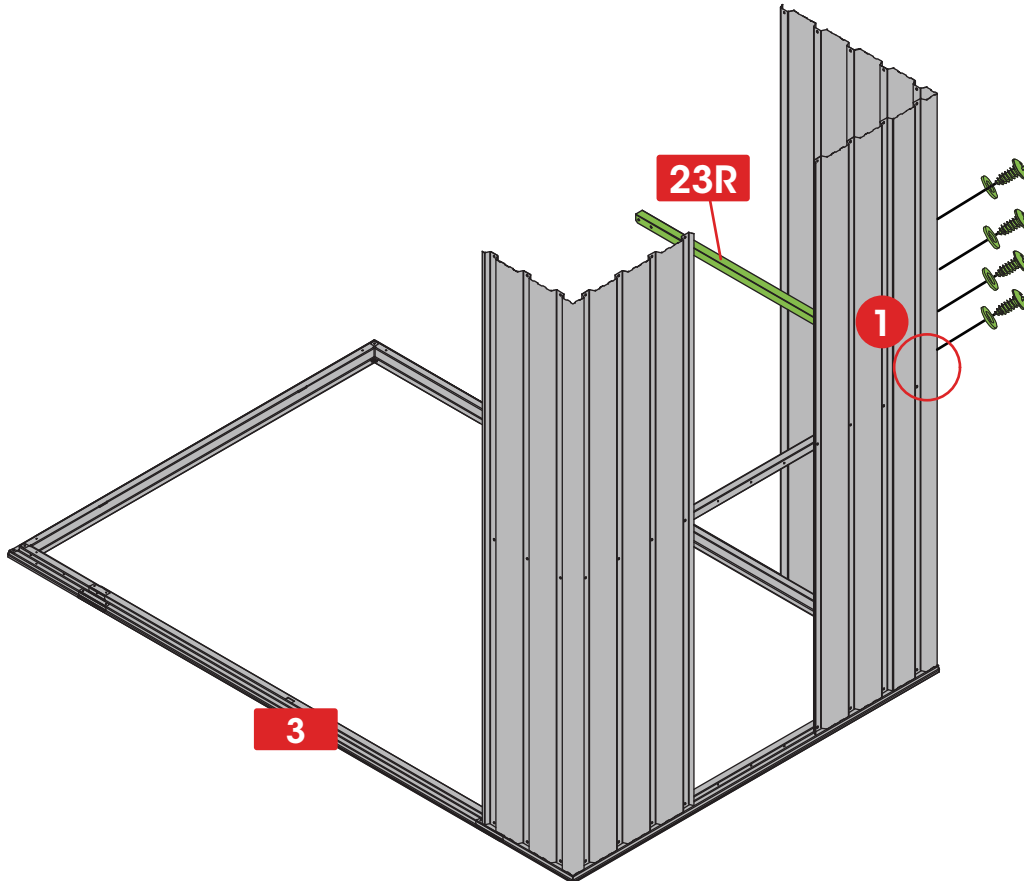

9

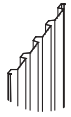

P2 X 1

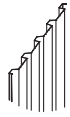

P9 X 1

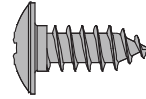

F1 X 7



S3 X 7

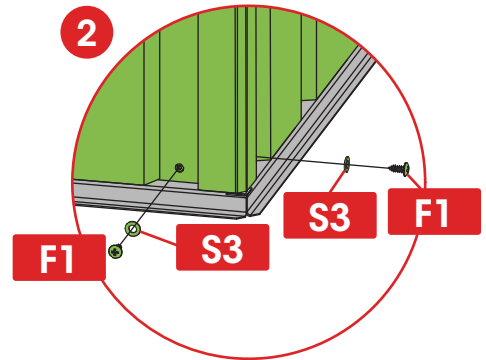
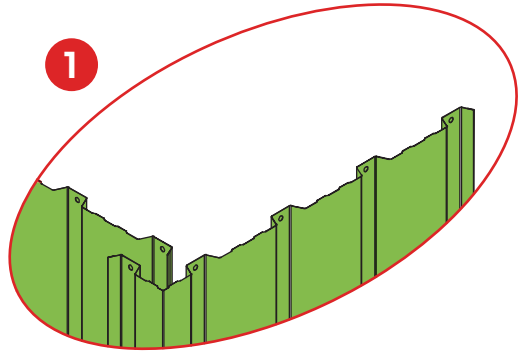
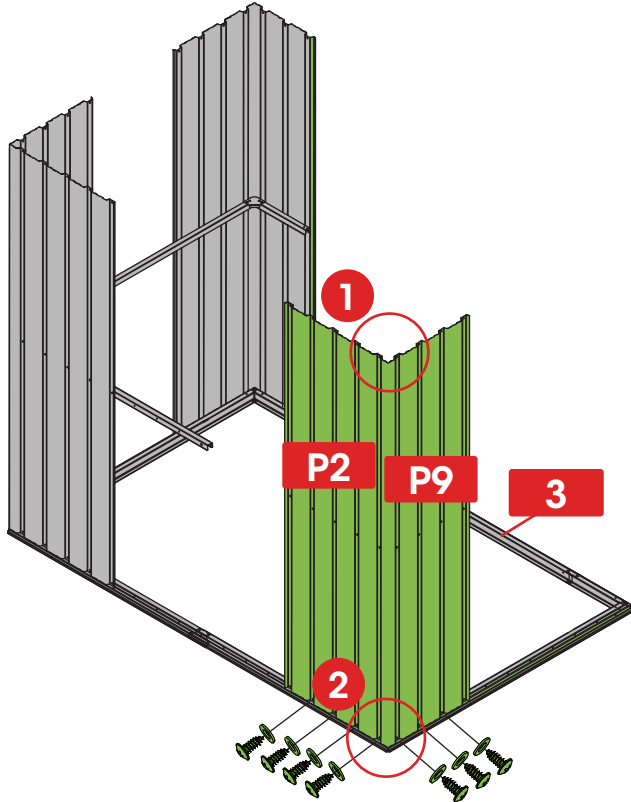

10

22 X 1 23L X 1 L X 1

F1 X 13 S3 X 7

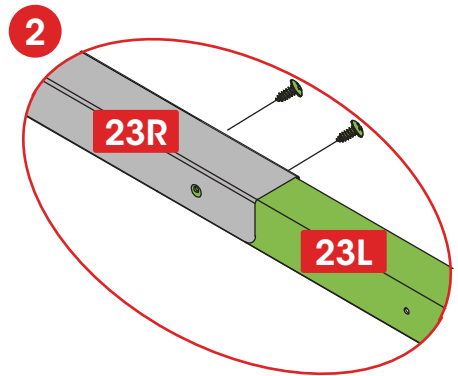
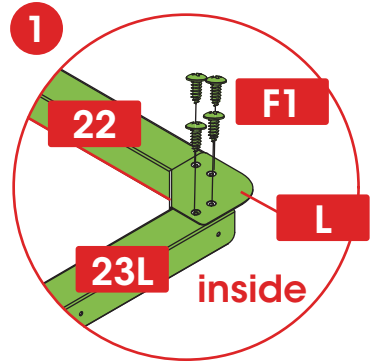
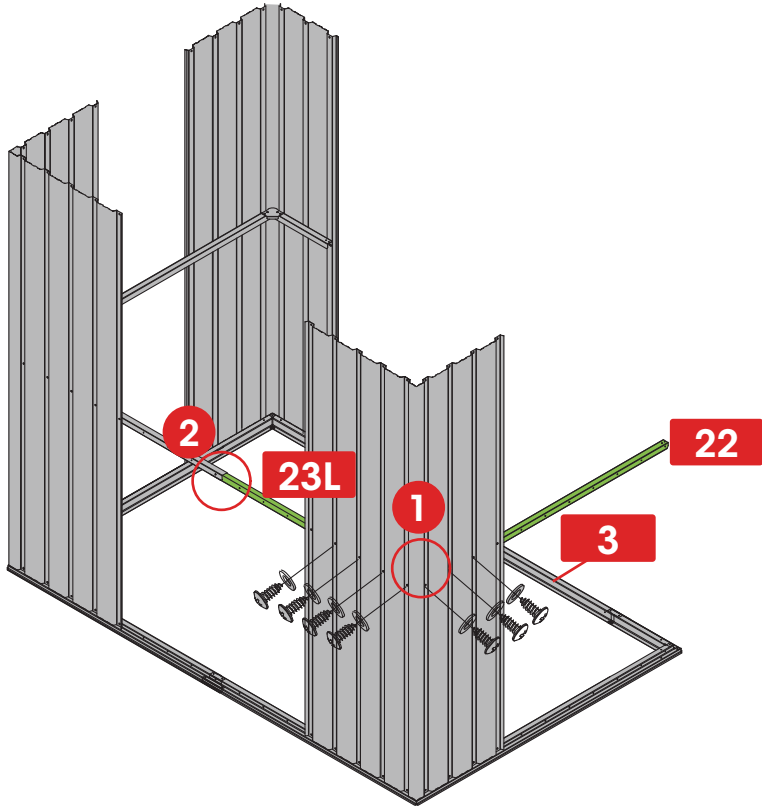
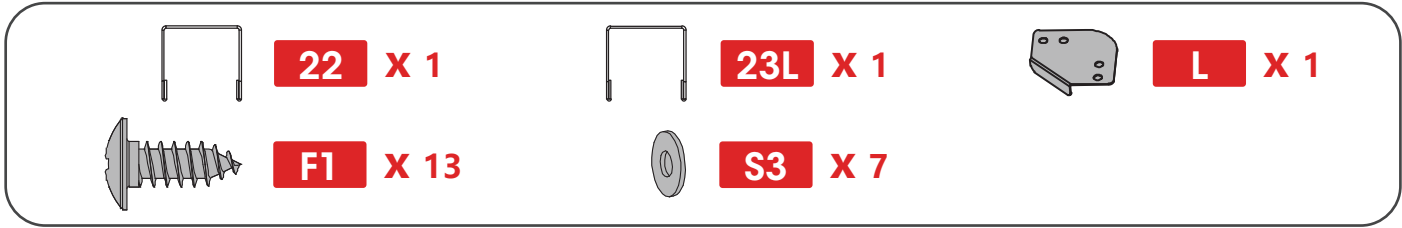

11

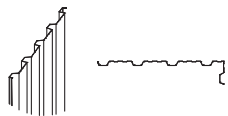

P9 X 1

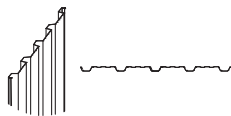

P13 X 1

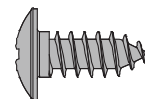

F1 X 8



S3 X 8

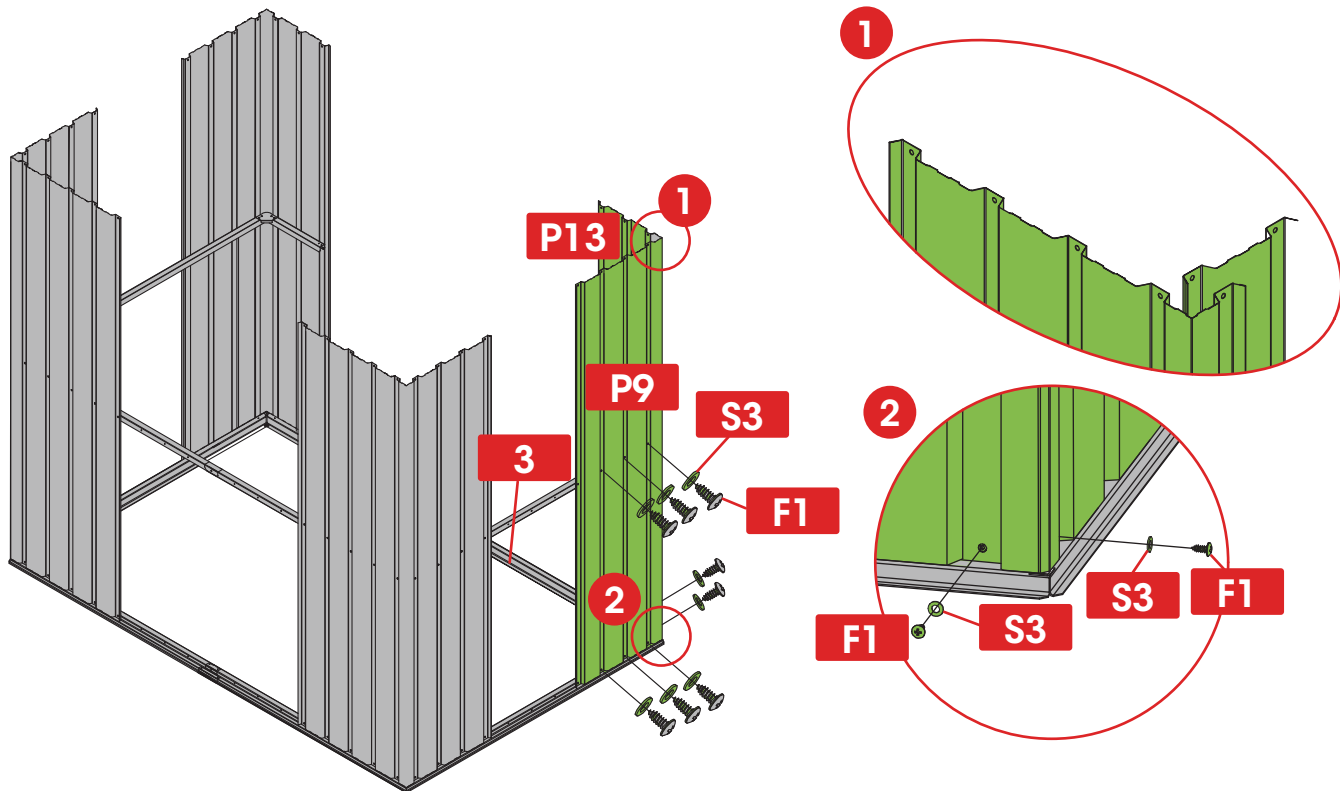

12



24 X 1



L X 1

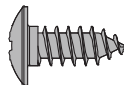

F1 X 6



S3 X 2

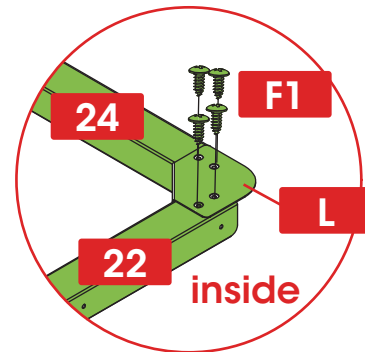
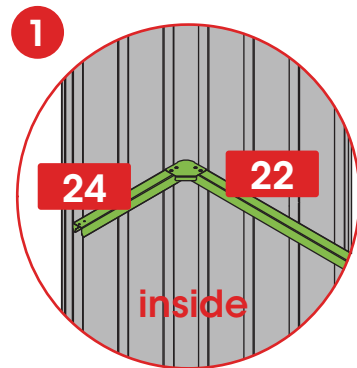
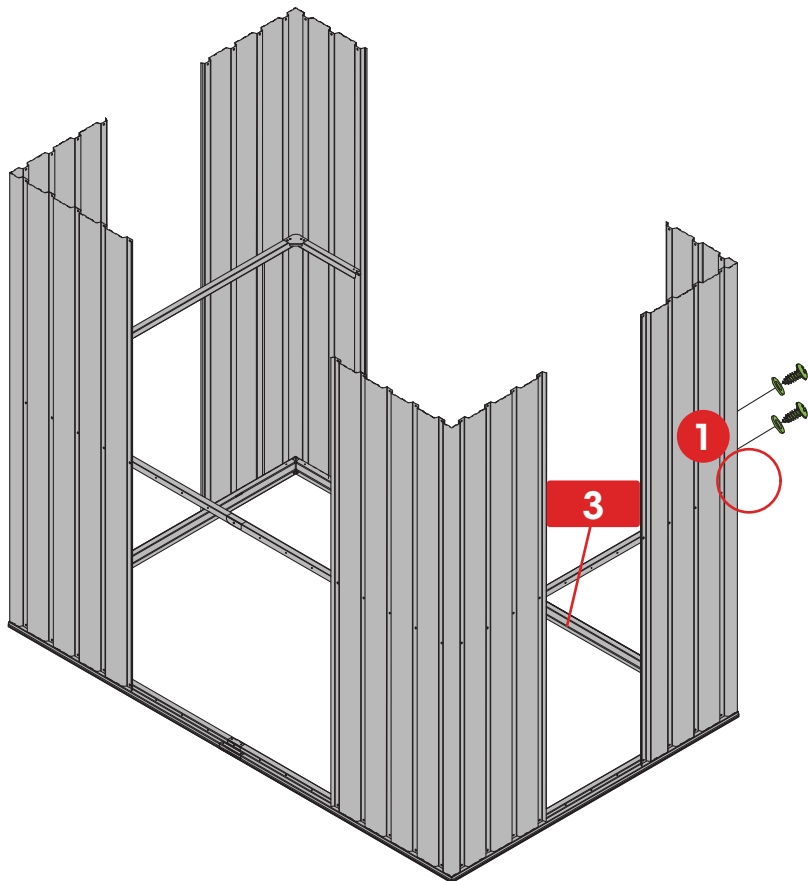

13



9 X 2

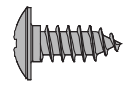

F1 X 12



S3 X 12

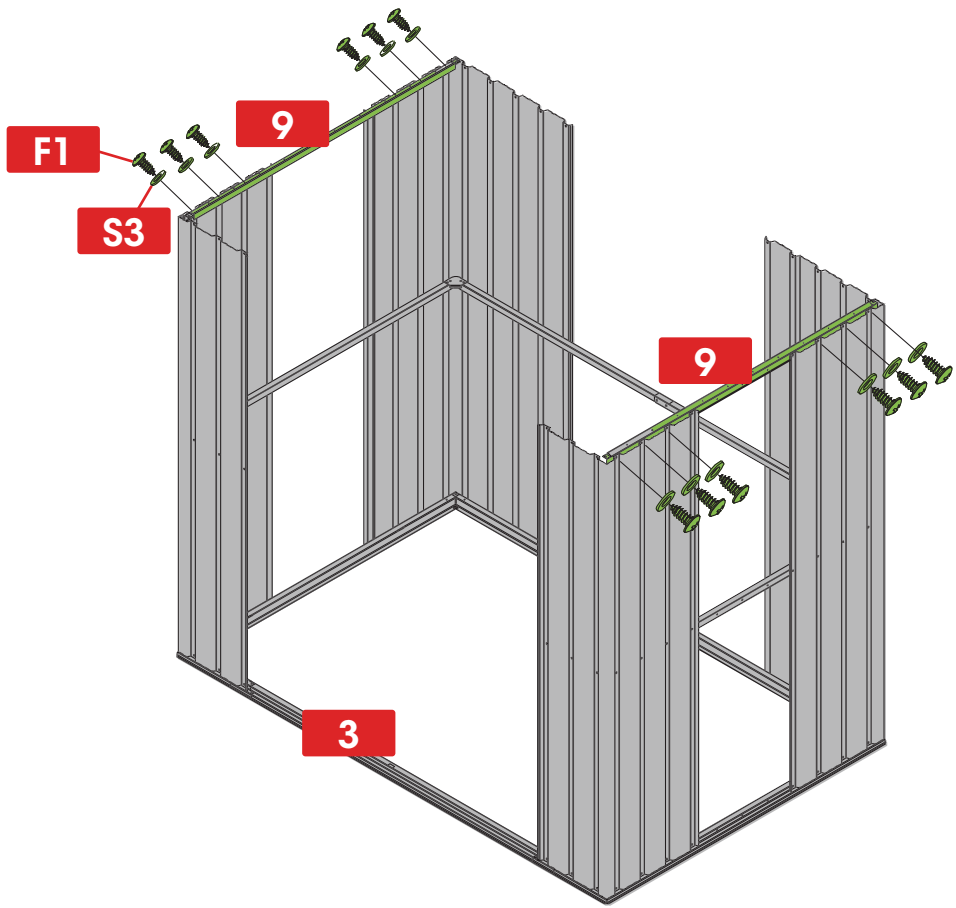

14

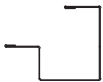

4L X 1



4R X 1

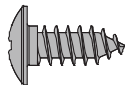

F1 X 6



S3 X 4

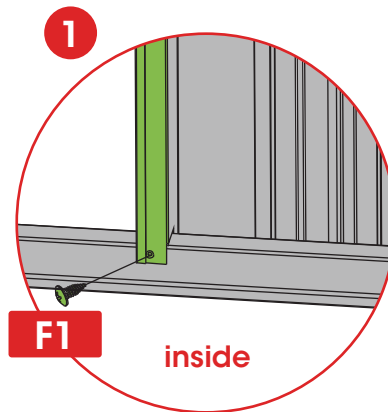
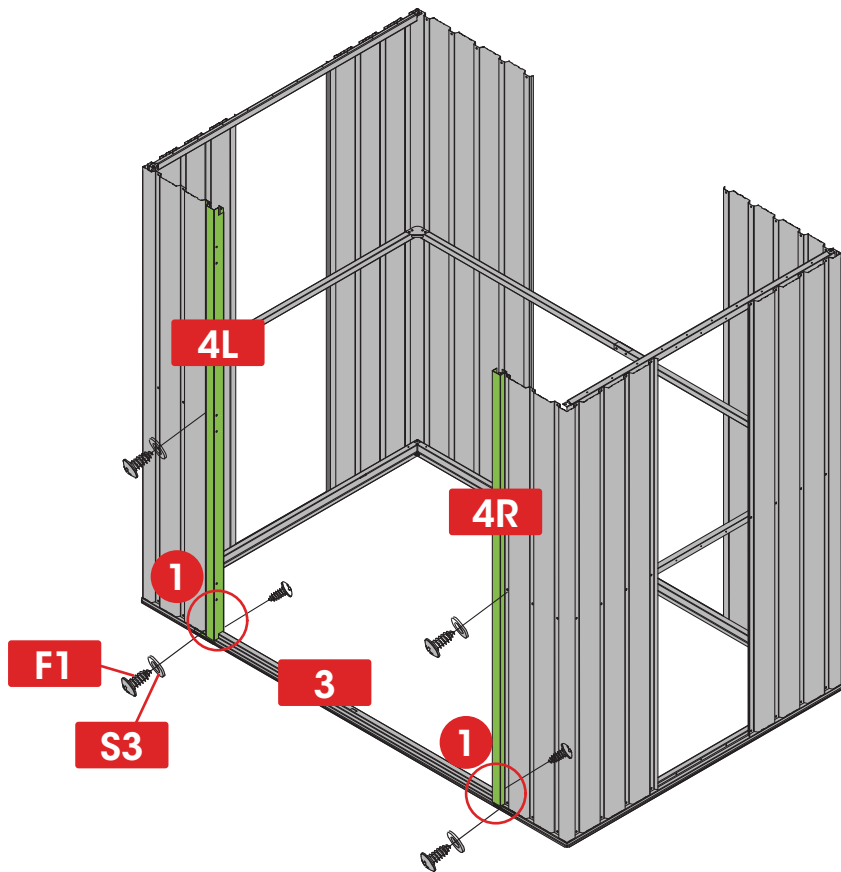

15



10L X 1



10R X 1

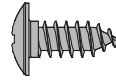

F1 X 10



S3 X 8

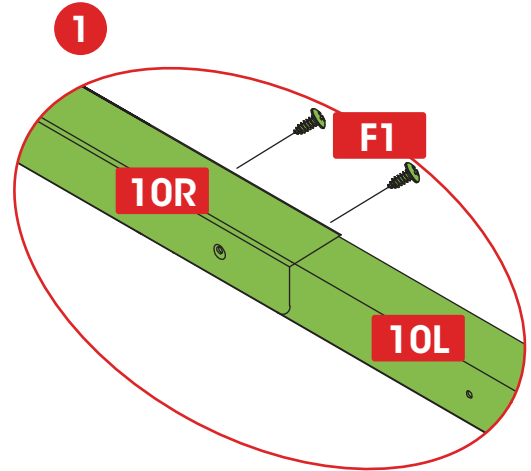
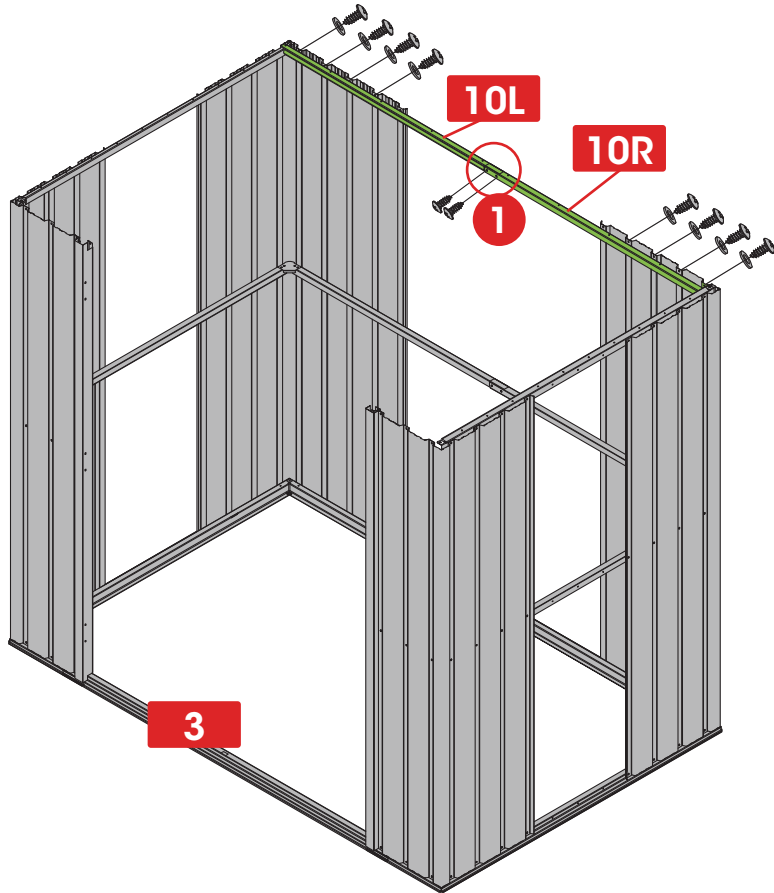

16

7L X 1 7R X 1 7 X 1 F1 X 8

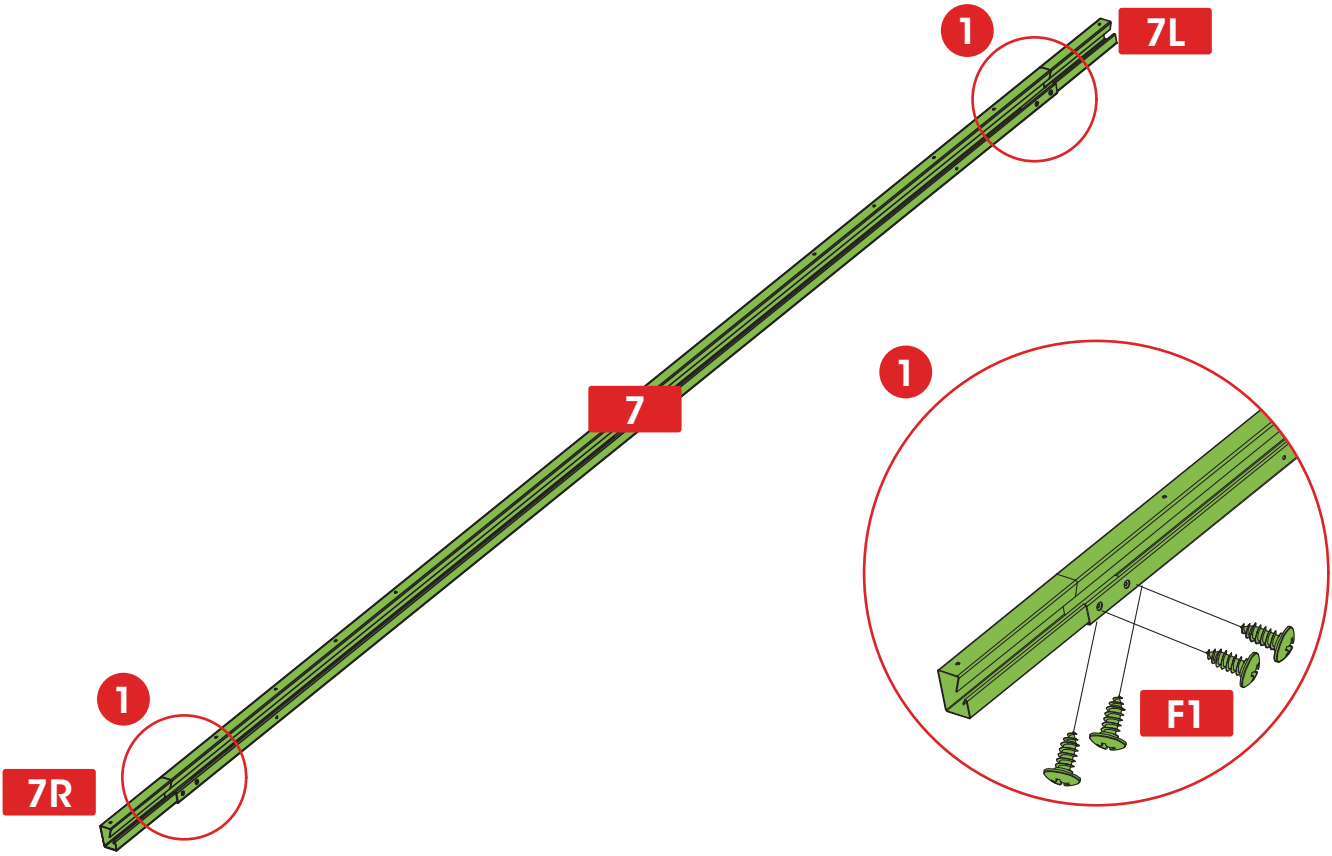

17

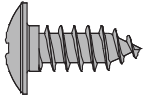

F1 X 6



S3 X 6

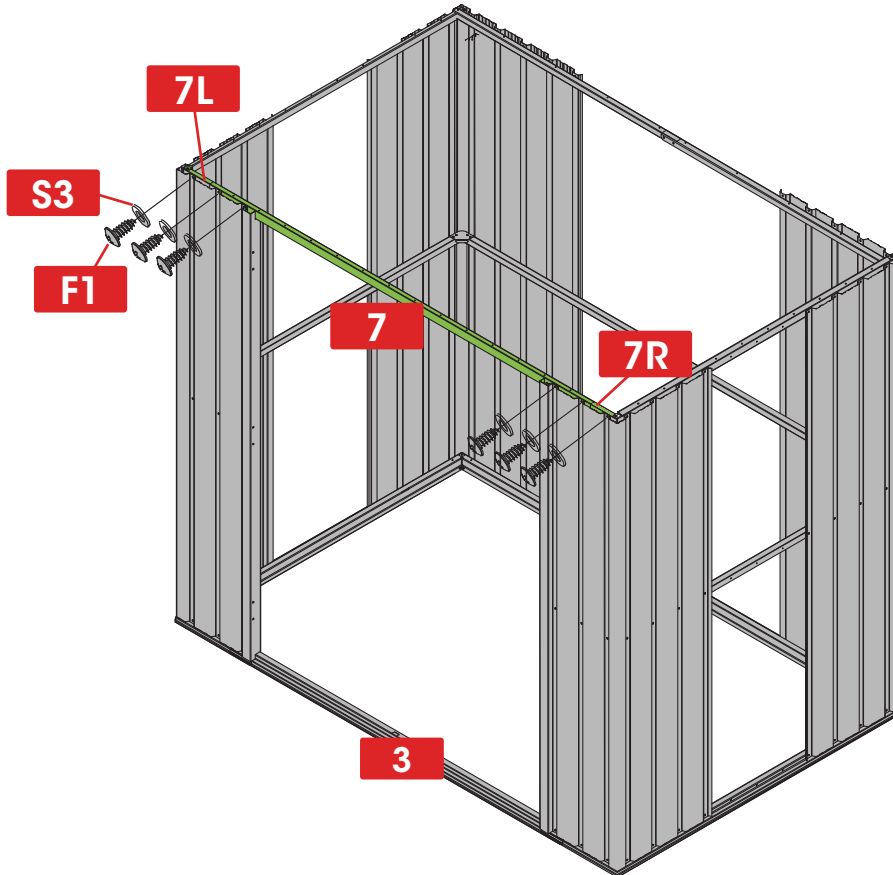

18



X1 X 3



X1 X 1

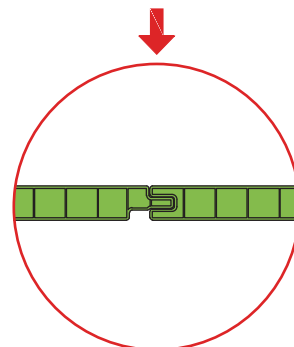
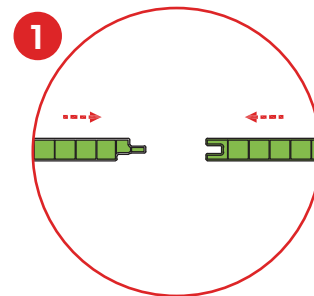
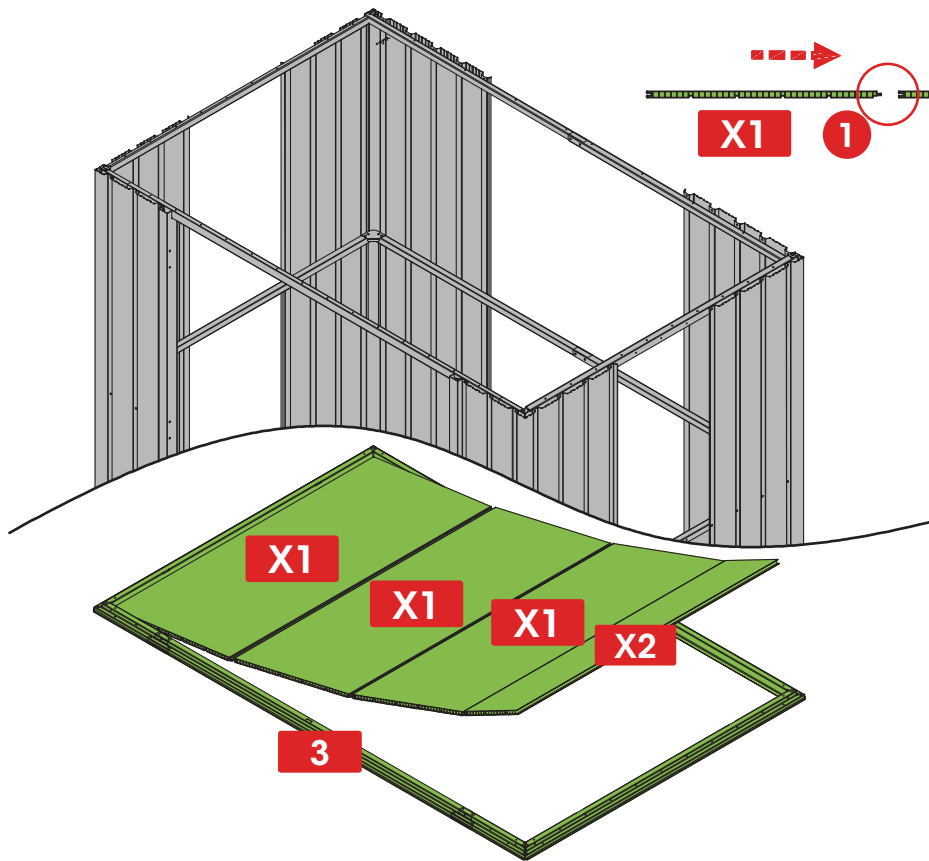

19

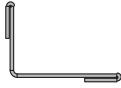

Y1 X 2

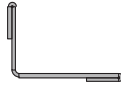

Y2 X 4

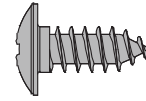

F1 X 34

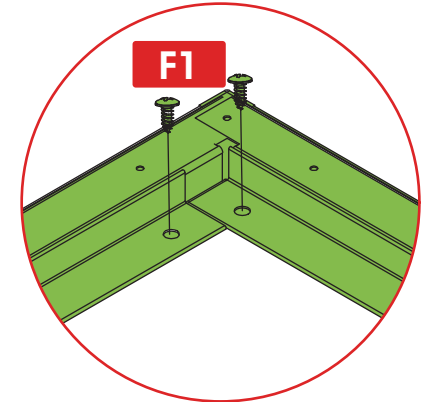
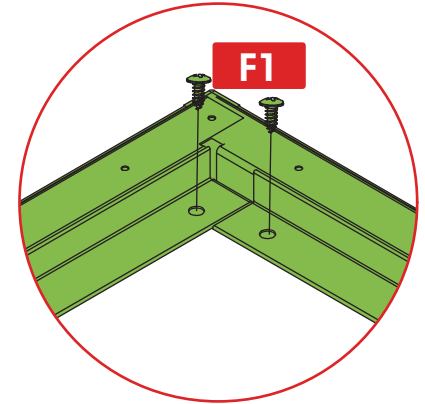
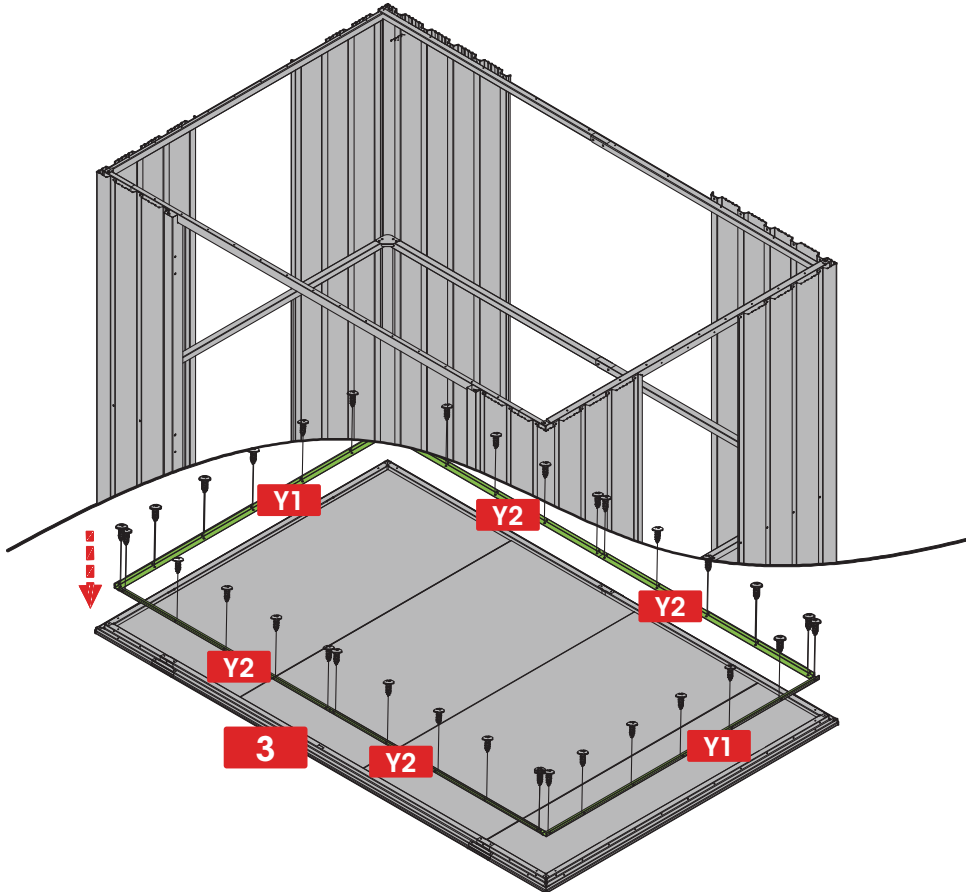

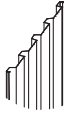

P2 X 4

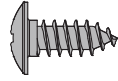

F1 X 57



S3 X 57

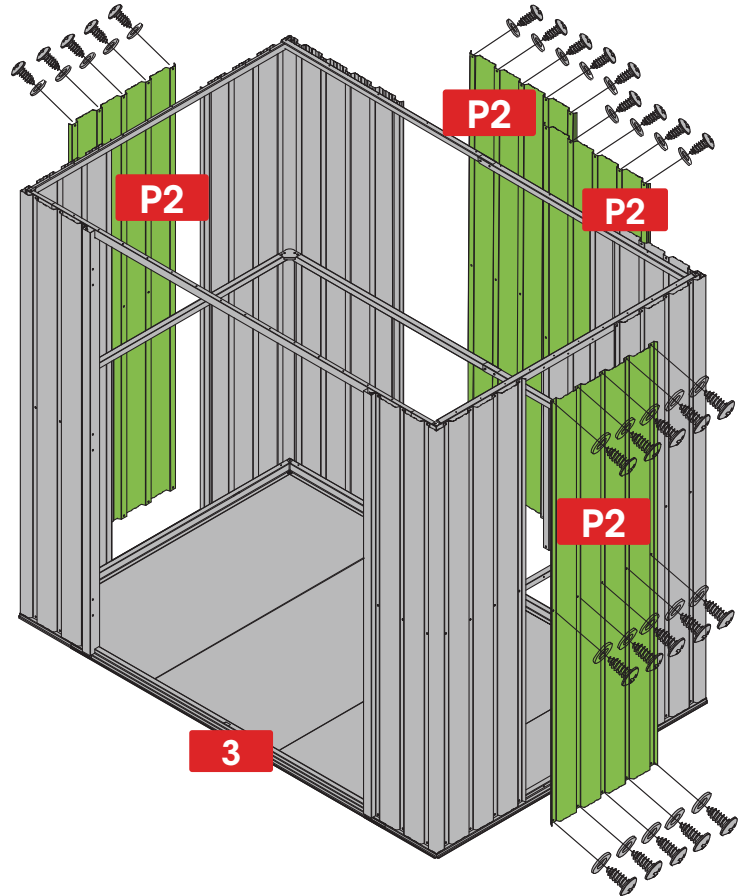
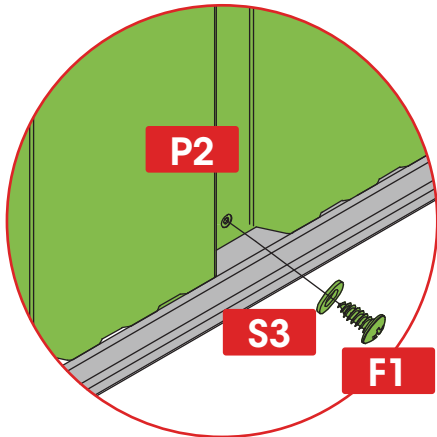

Part 4: Roof installation and internal fixing

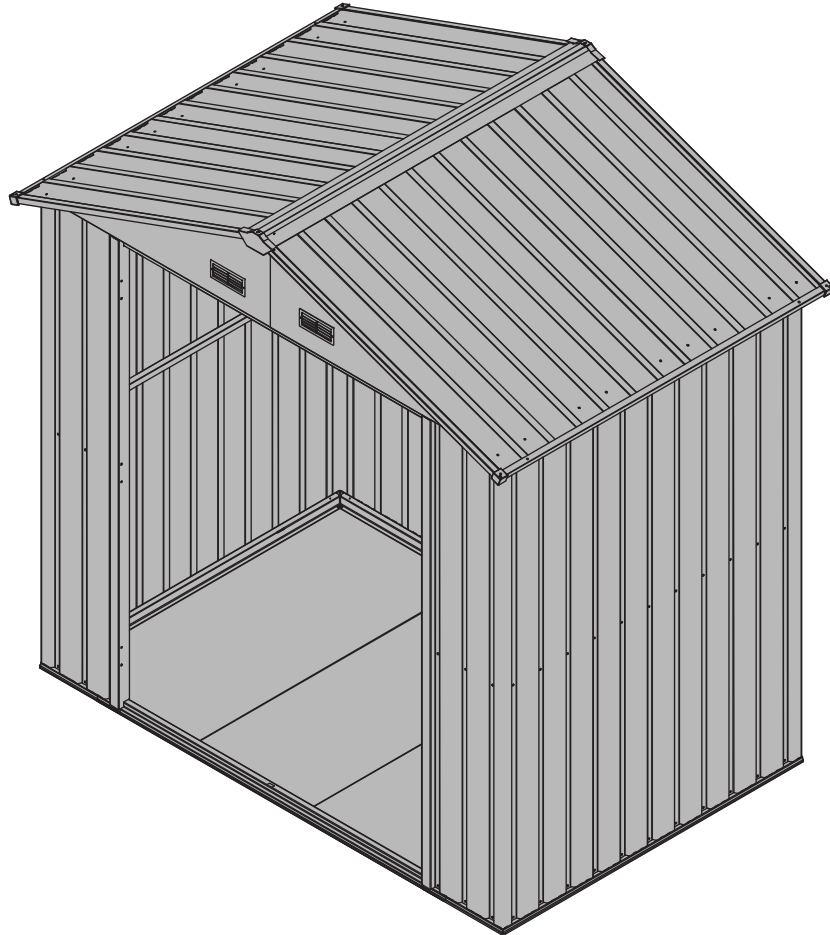

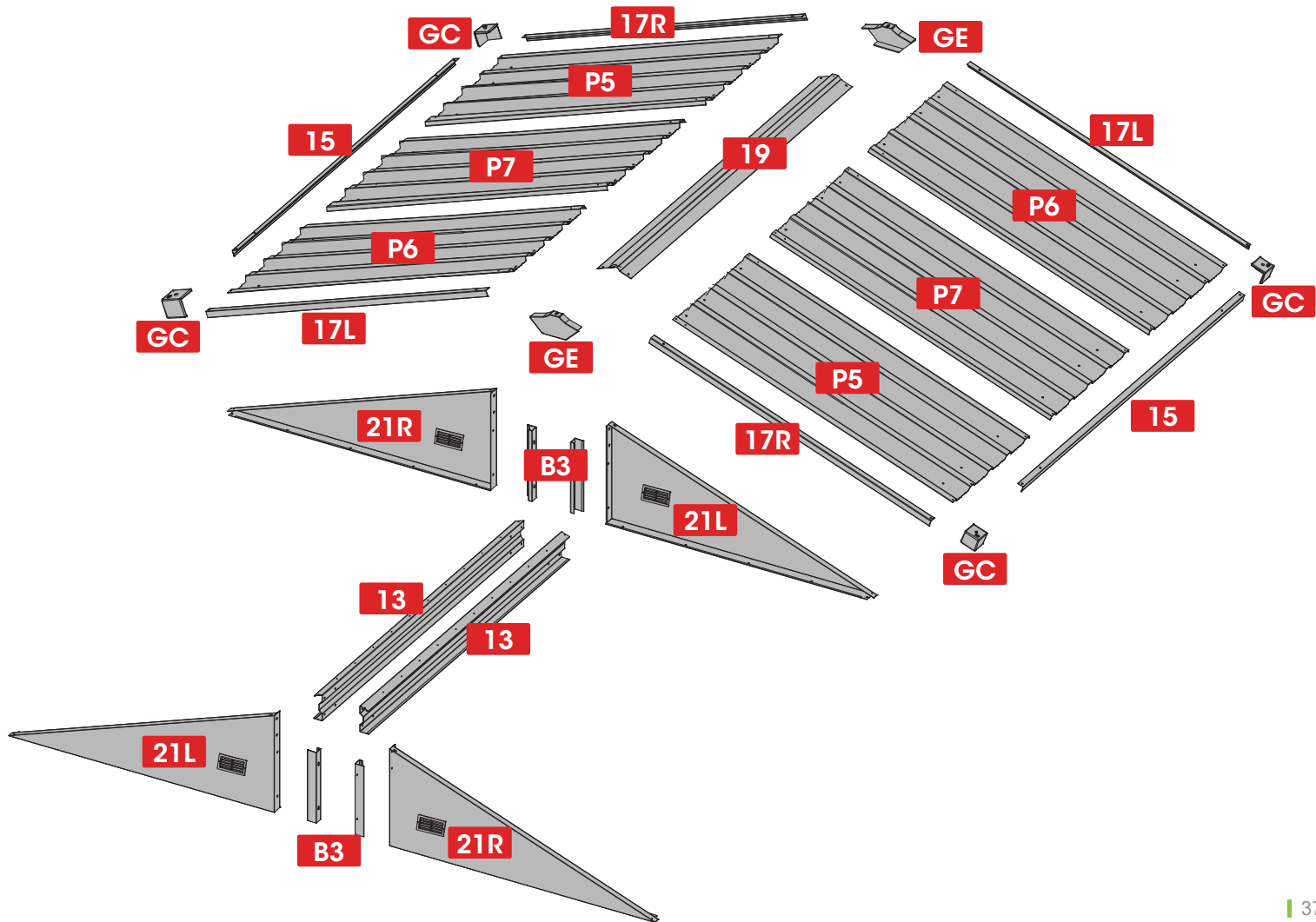

21



21L X 2

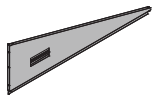

21R X 2



B3 X 4

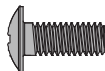

F2 X 4

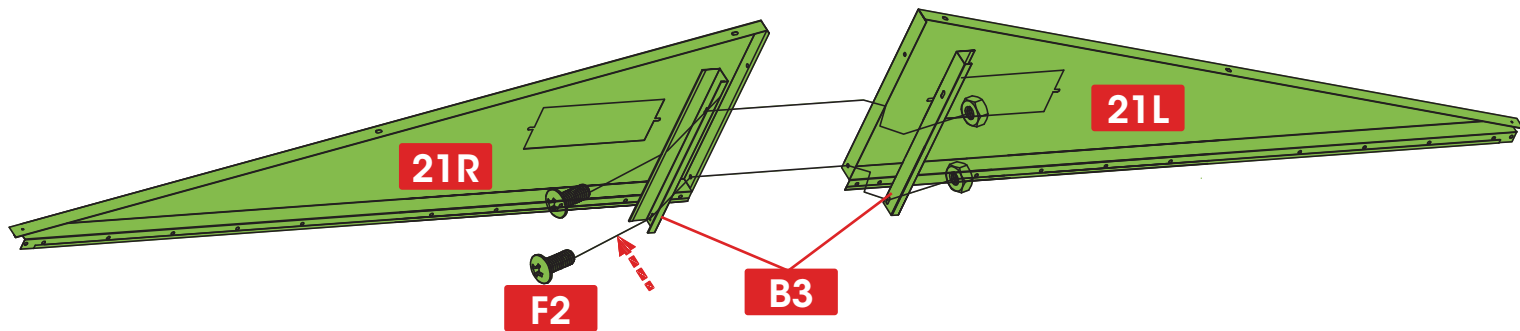

x 2

22

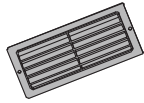

GF X 4

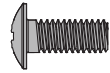

F2 X 8



S3 X 8

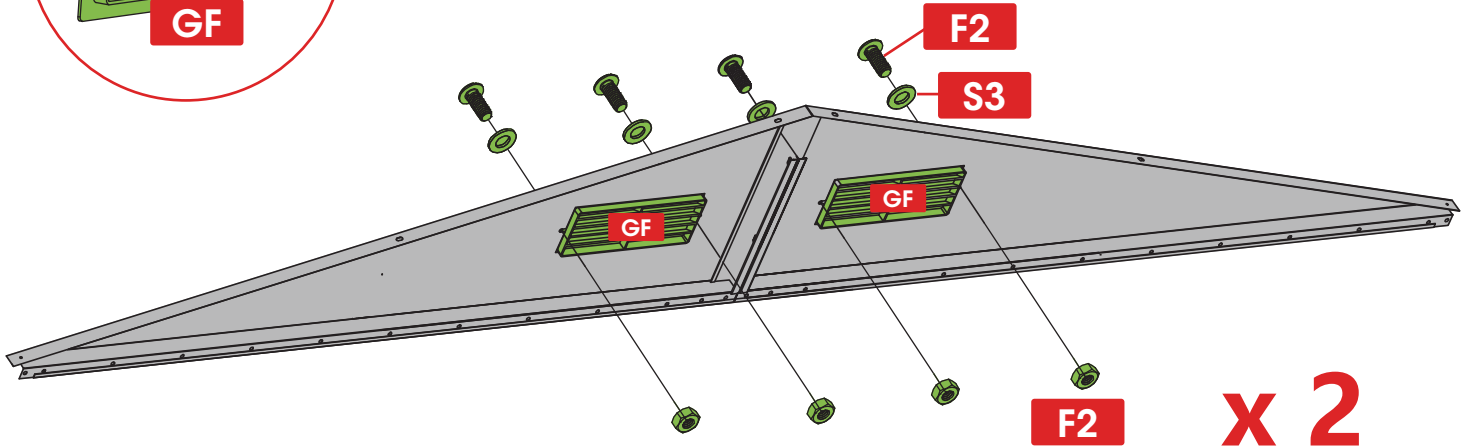
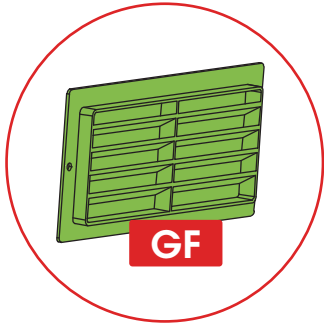

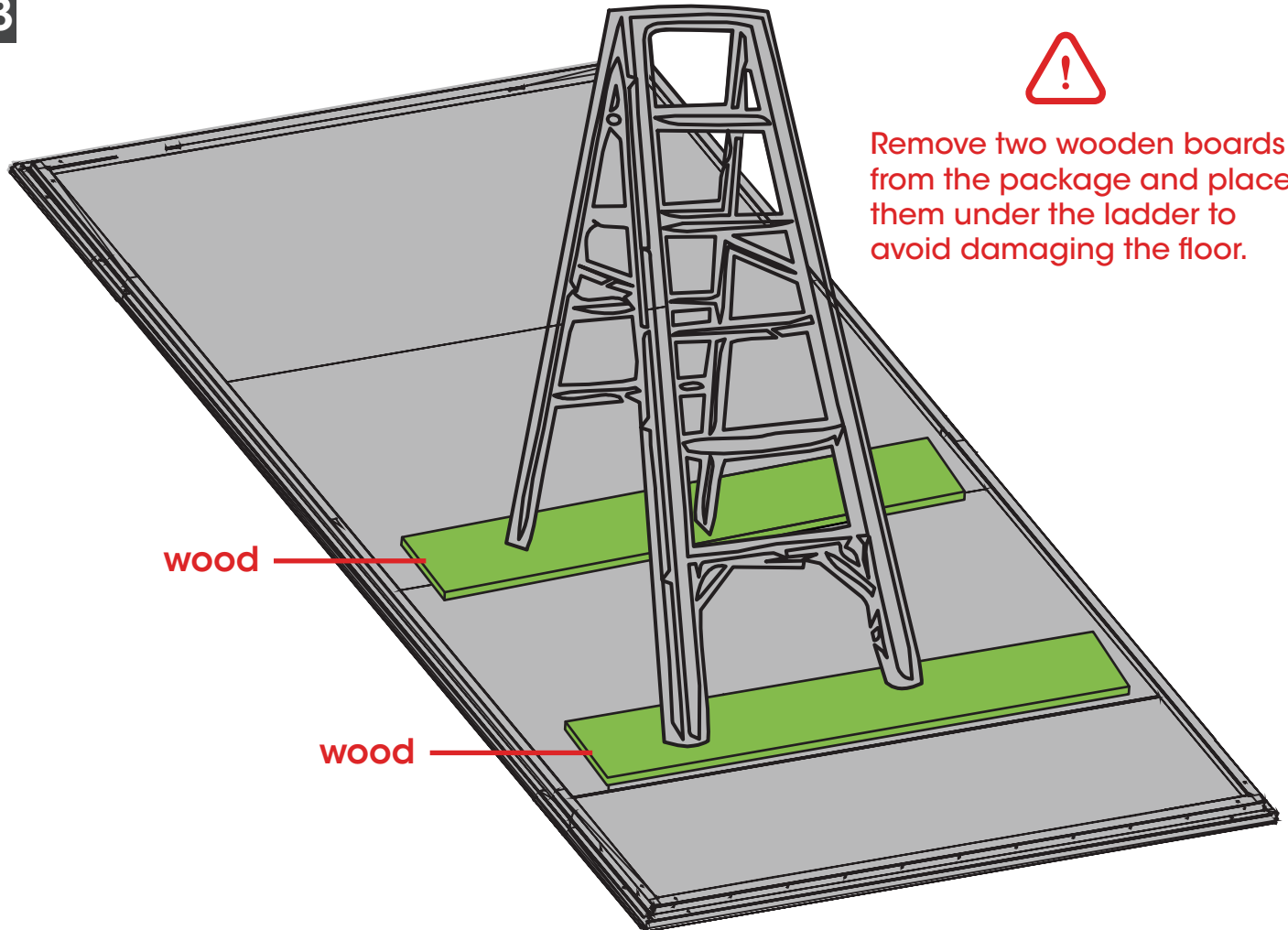

24

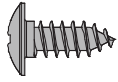

F1 X 10



S3 X 10

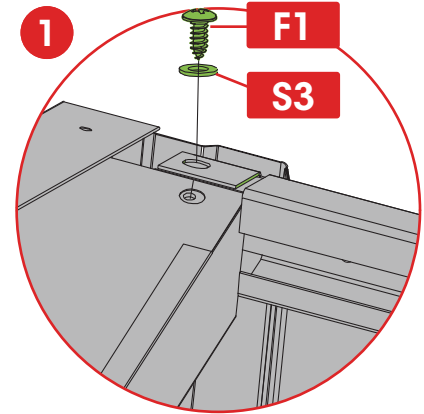
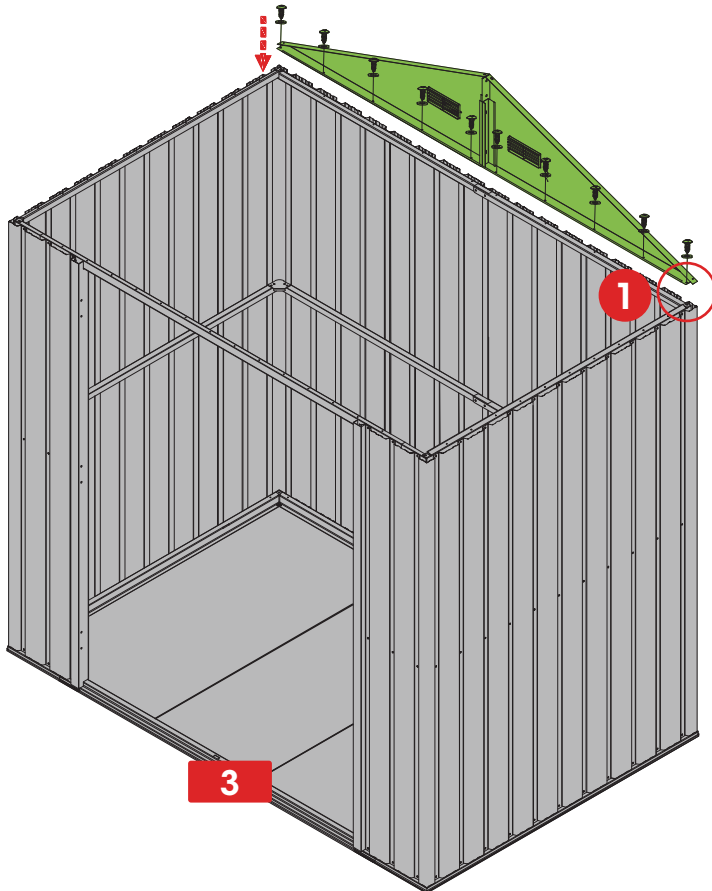

25

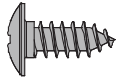

F1 X 10



S3 X 10

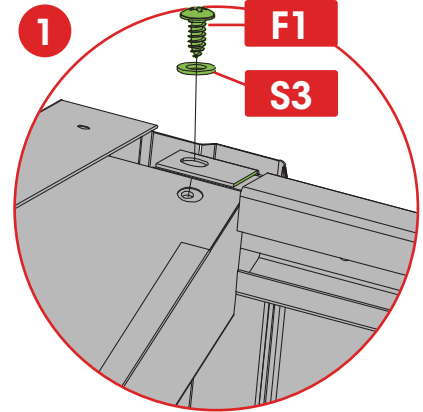
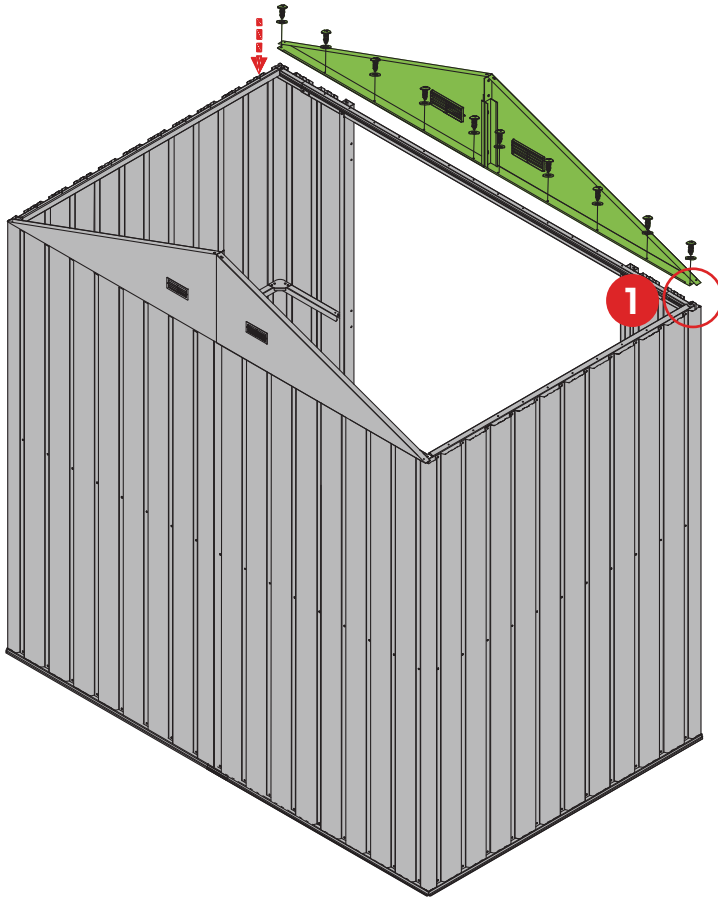

26

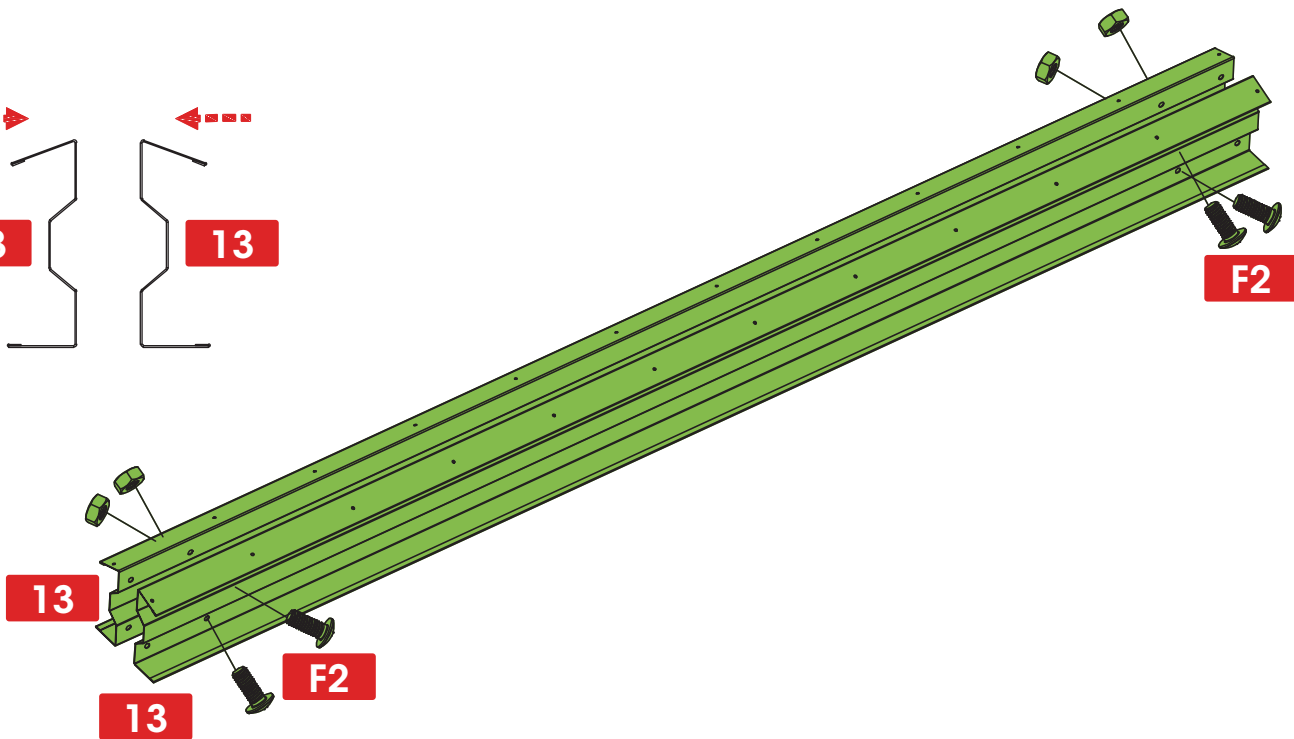
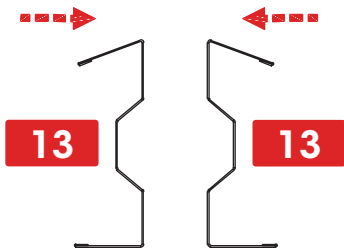
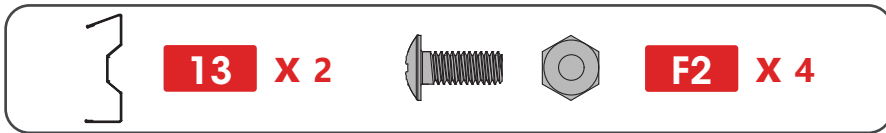

27

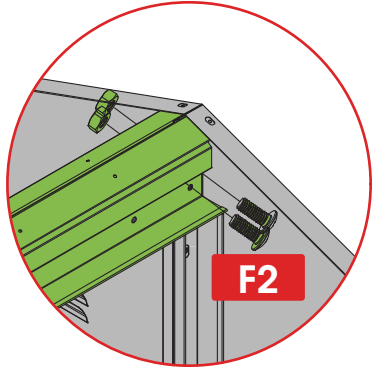
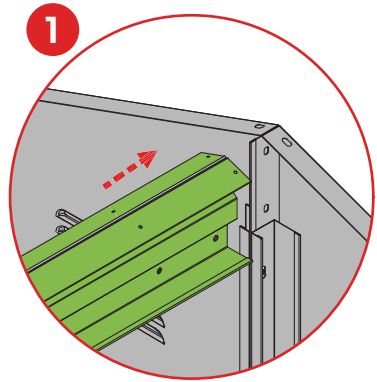
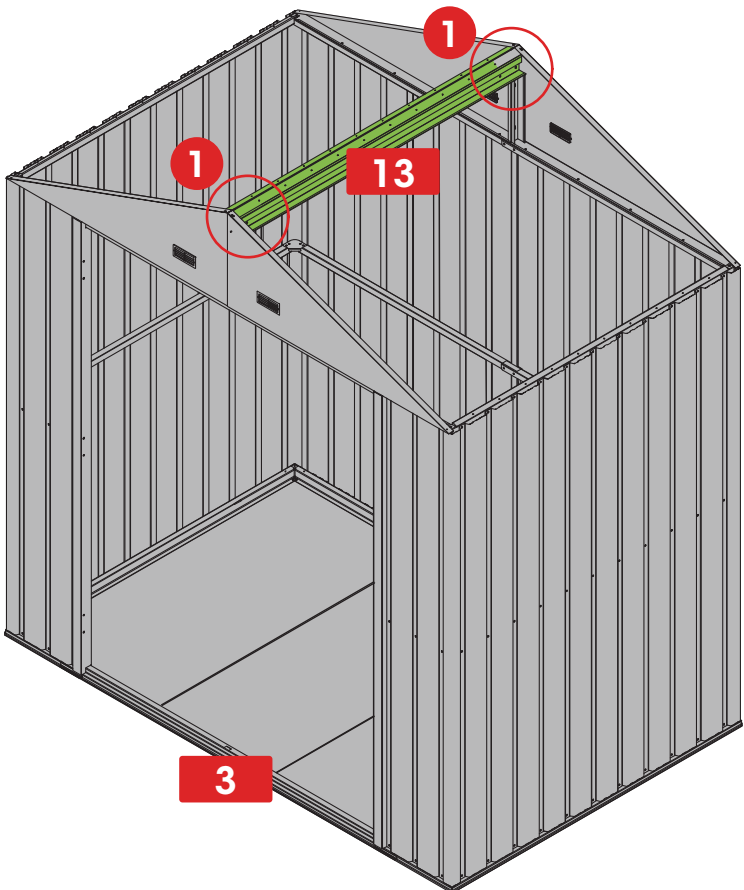

28

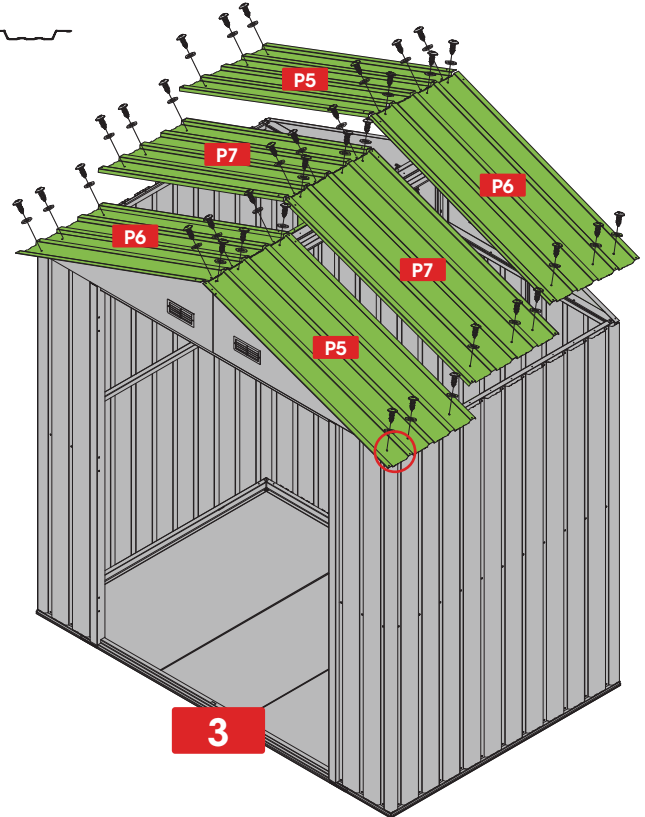
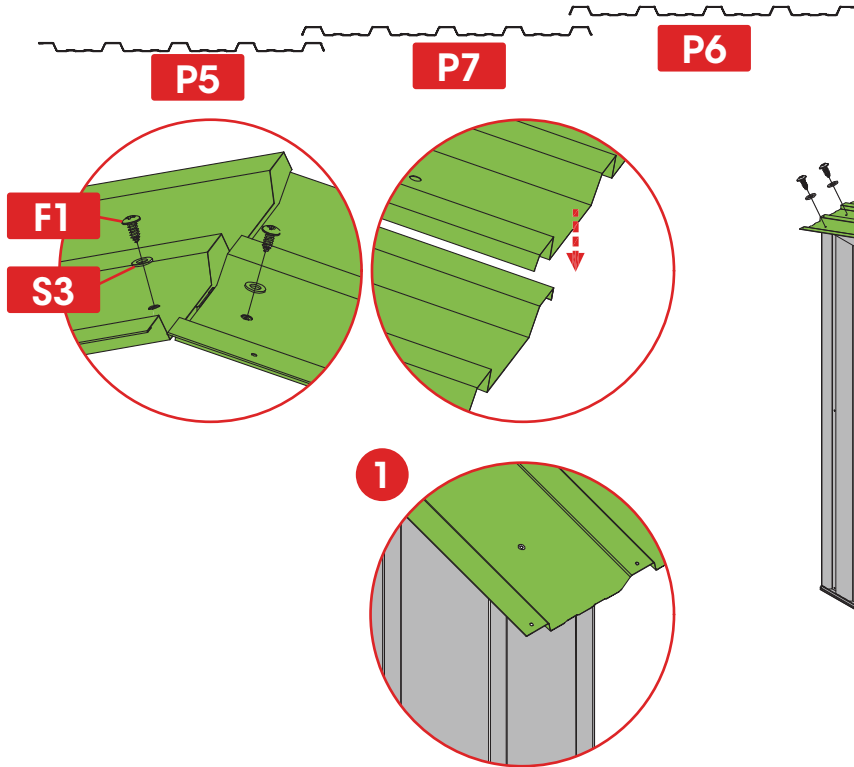
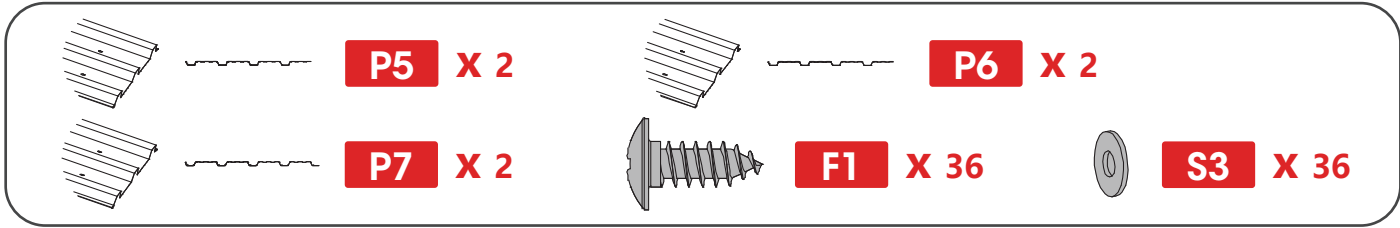

29

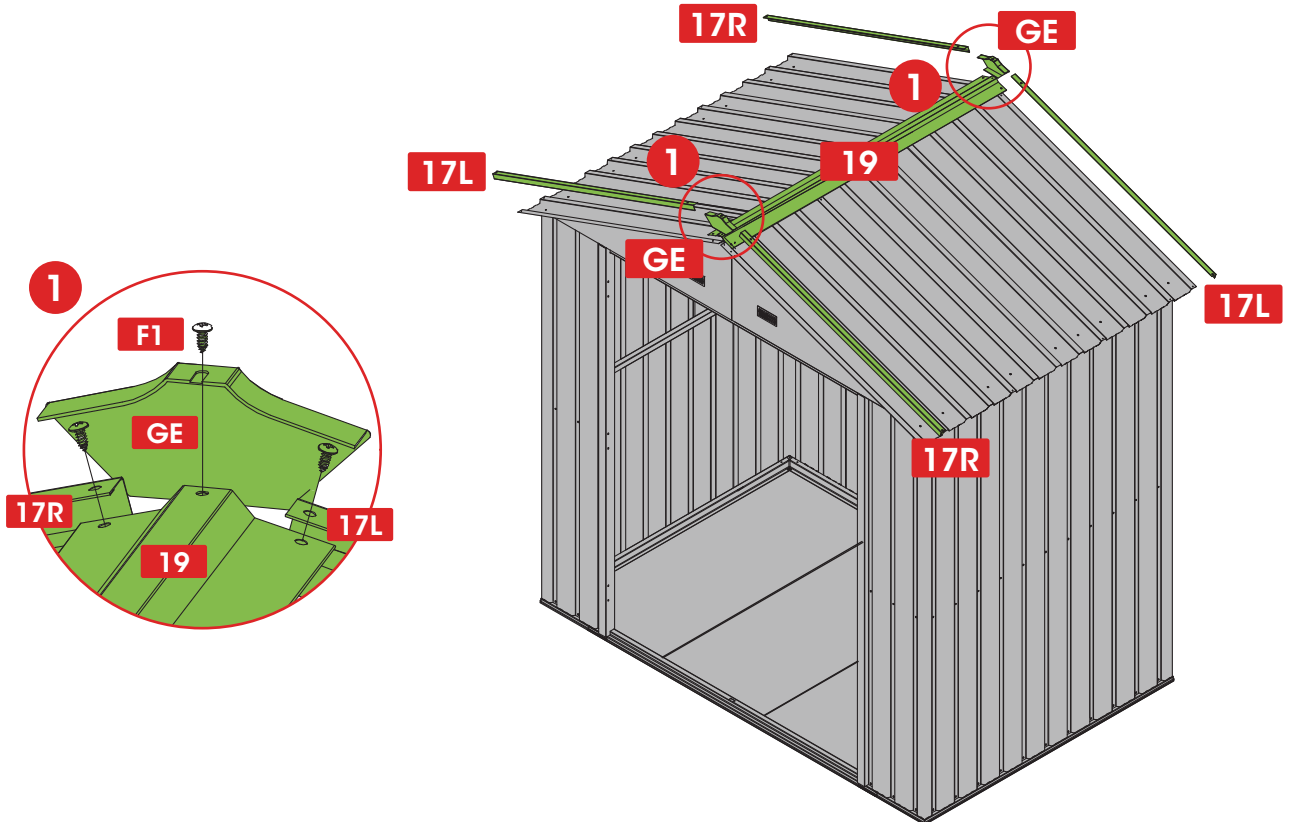
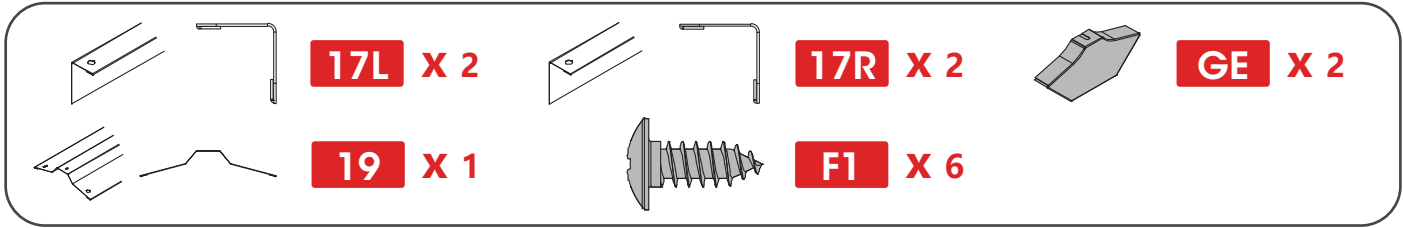

30



15 X 2



GC X 4

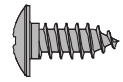

F1 X 8



S3 X 8

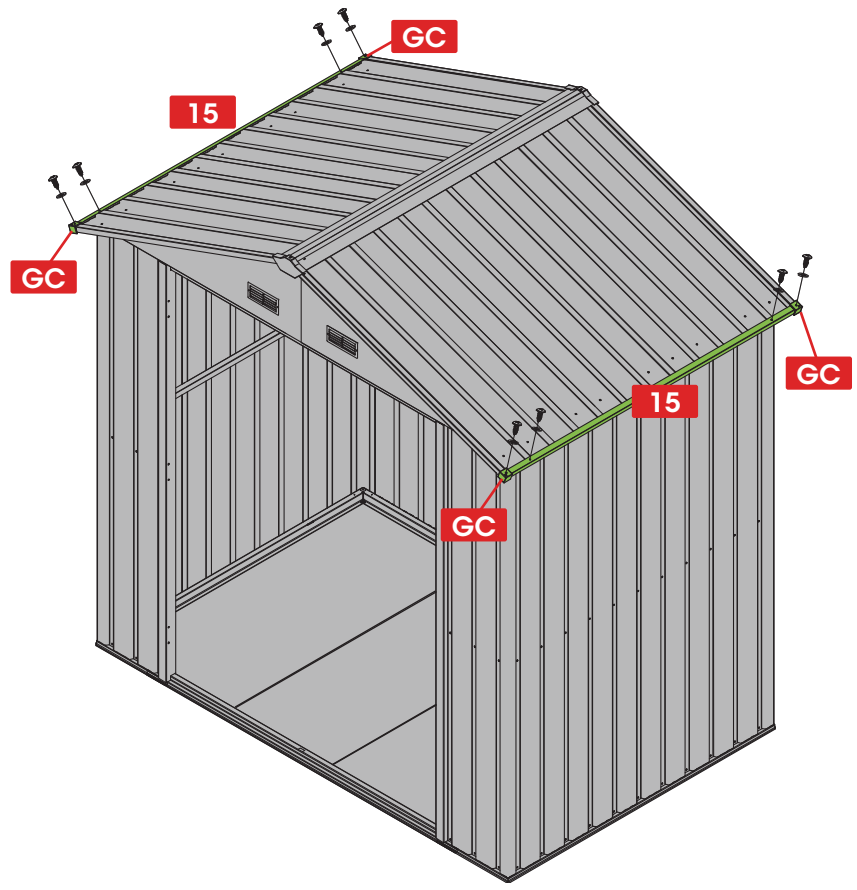
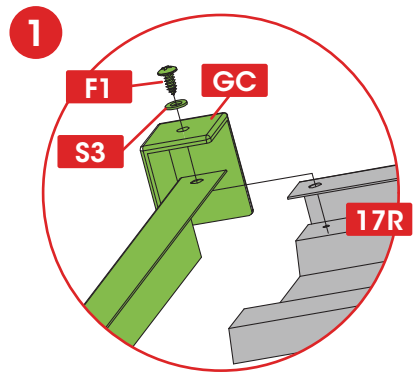

Part 5: Door installation and adjustment

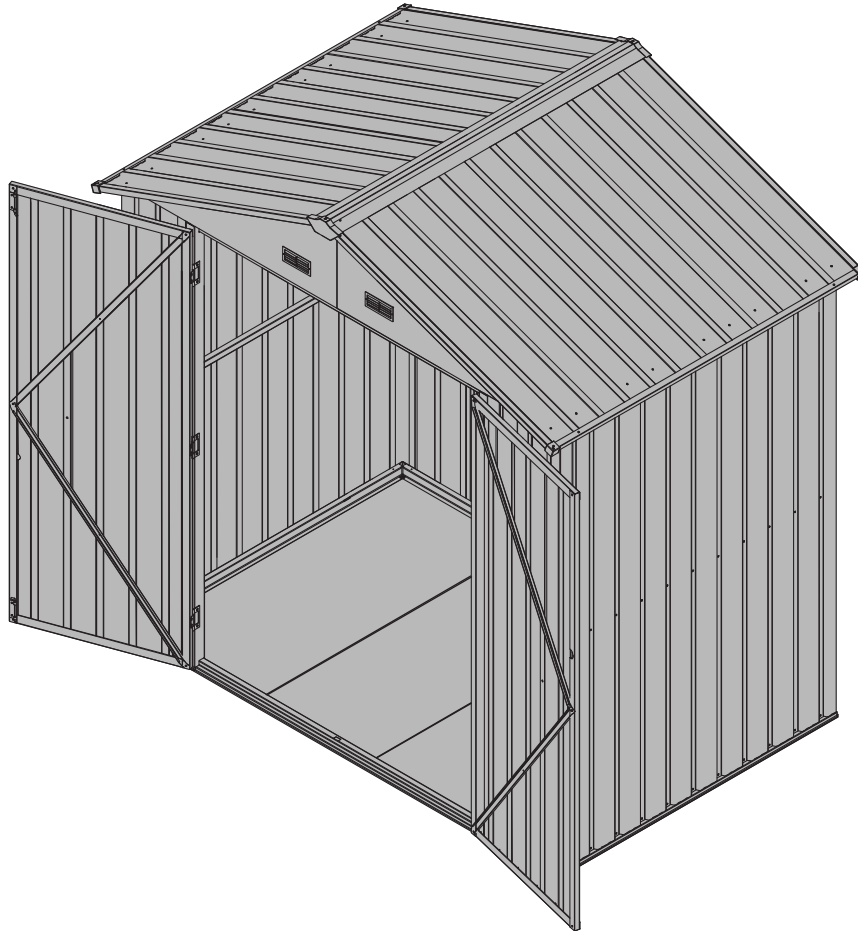

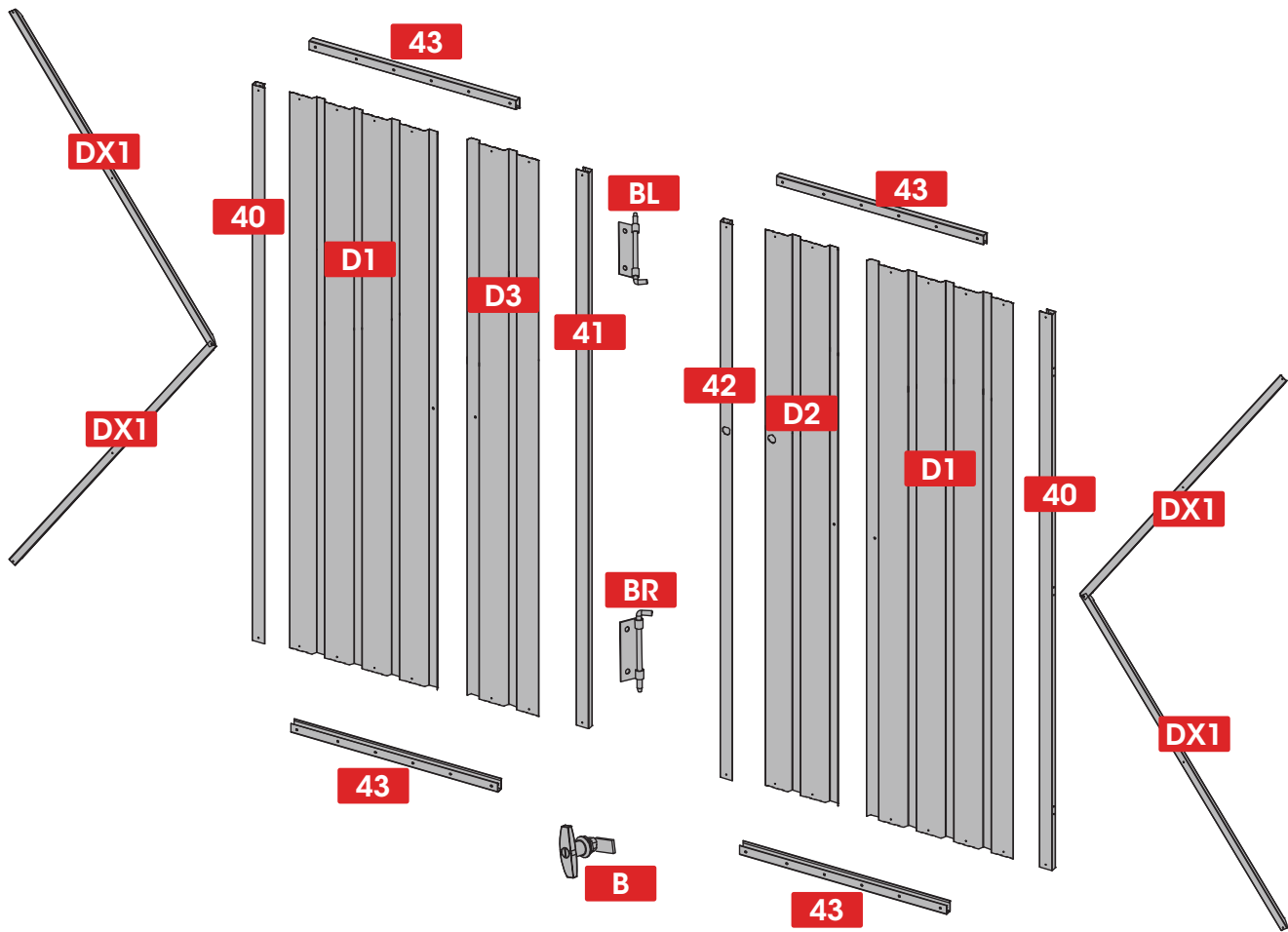

31

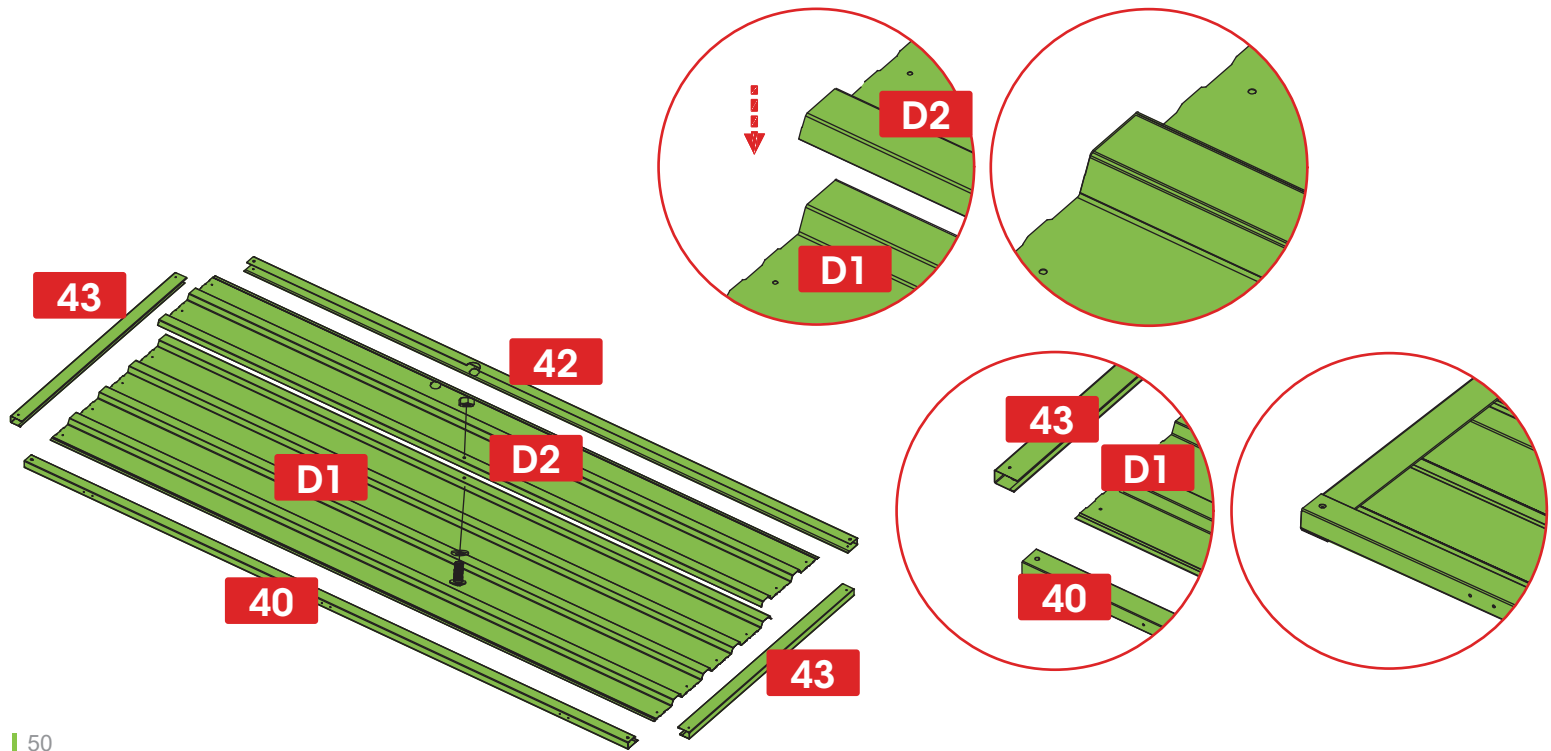
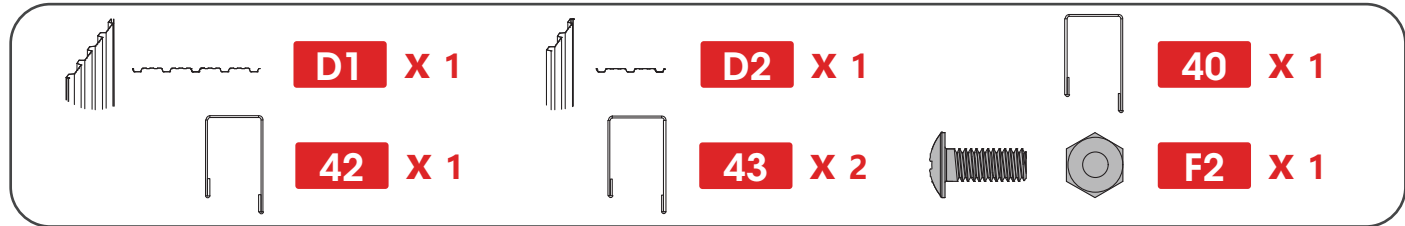

32



DX1 X 2

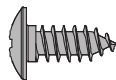

F1 X 5



S3 X 5

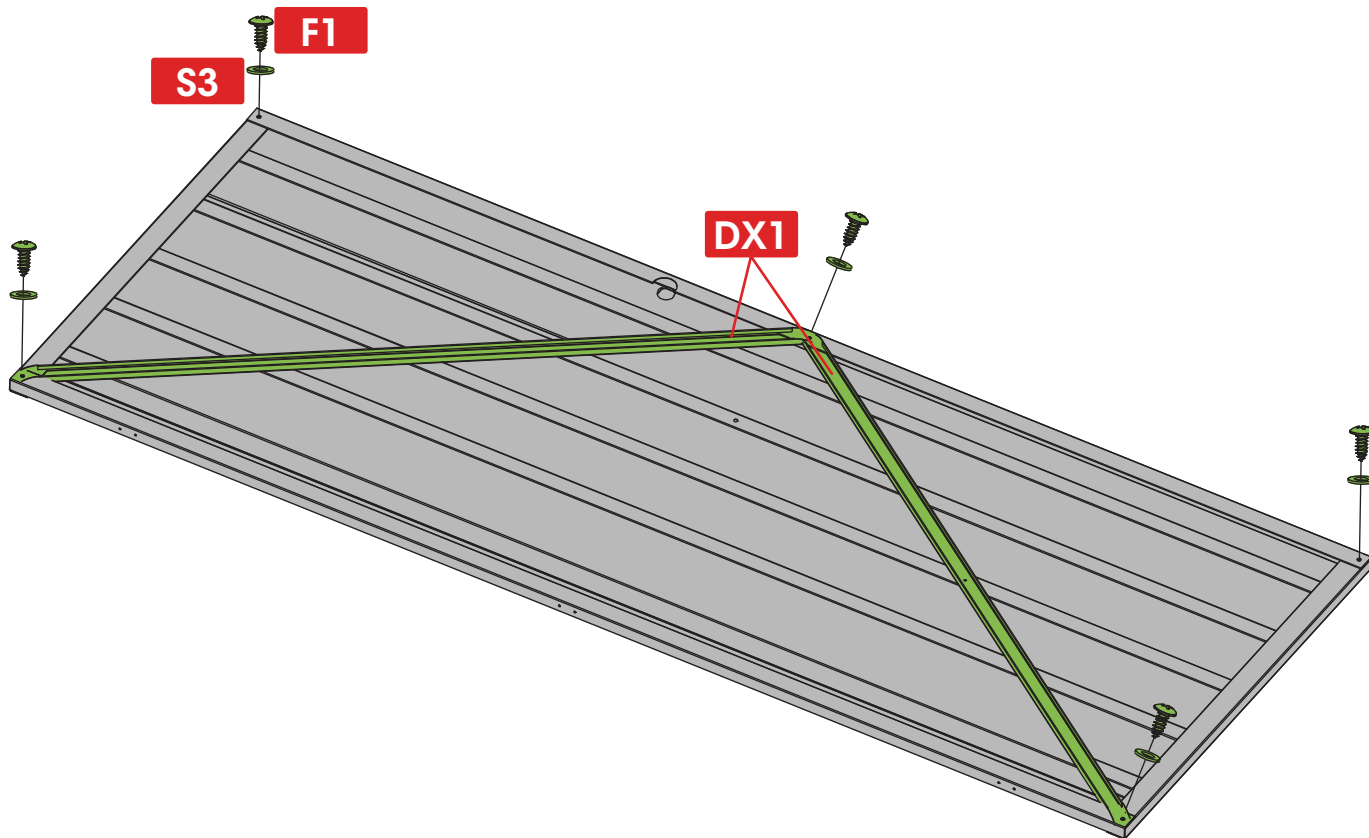

33

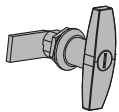

B X 1

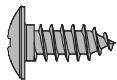

F1 X 12



S3 X 12

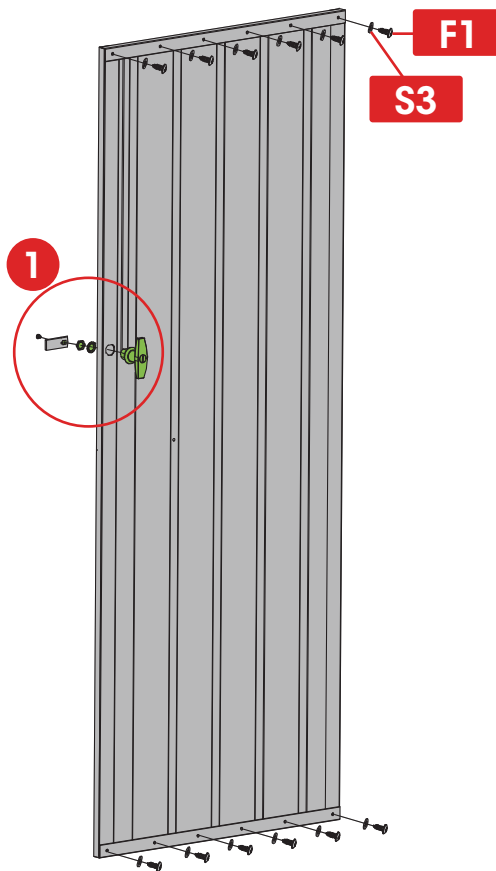
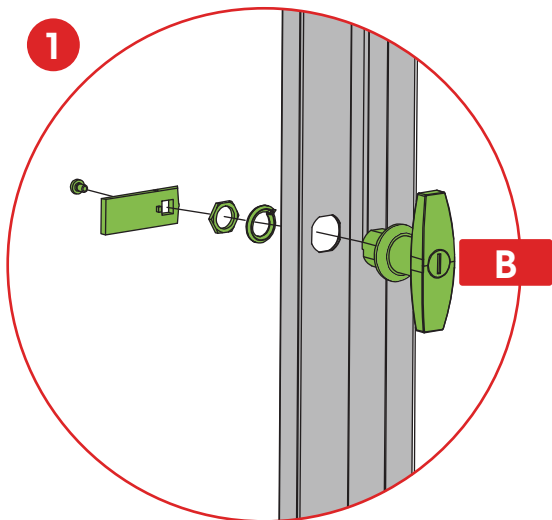

34

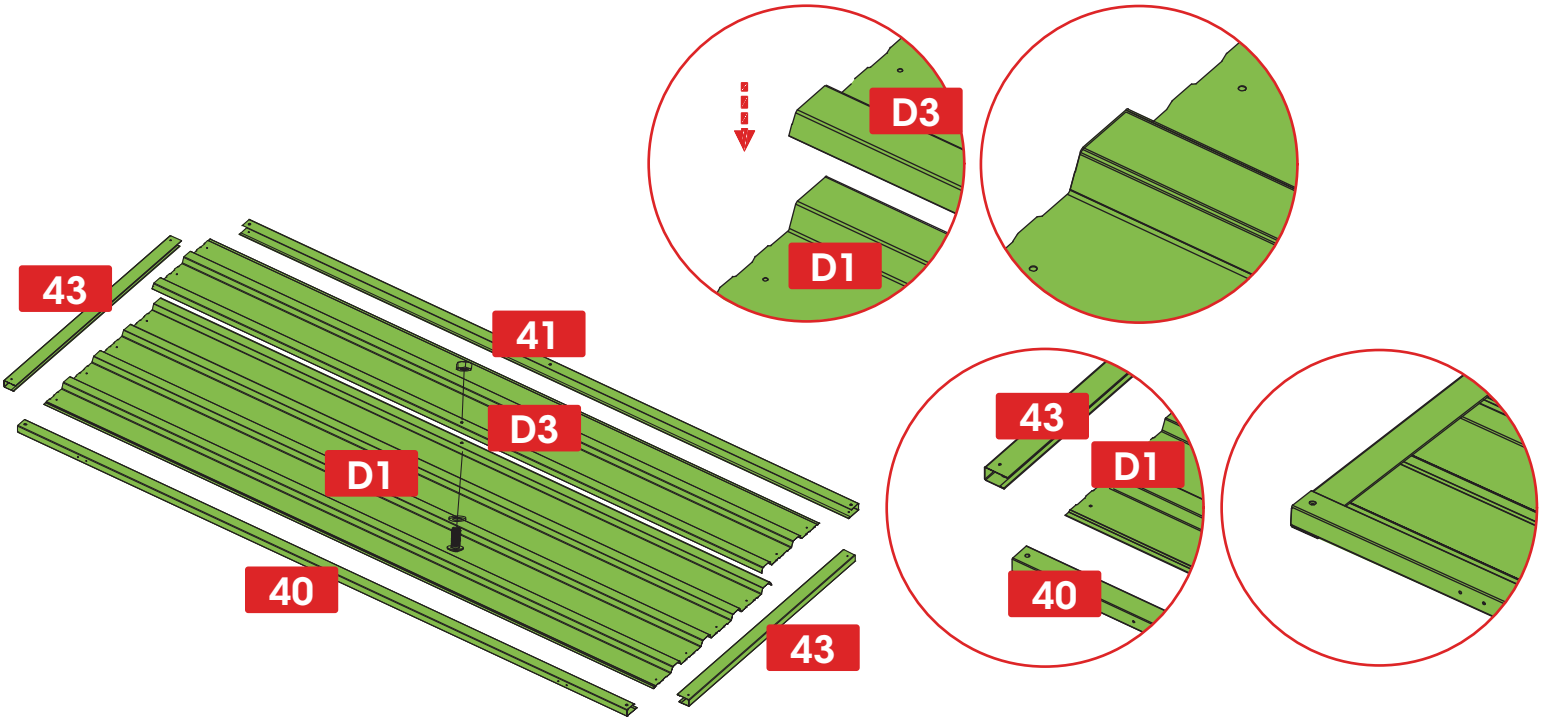
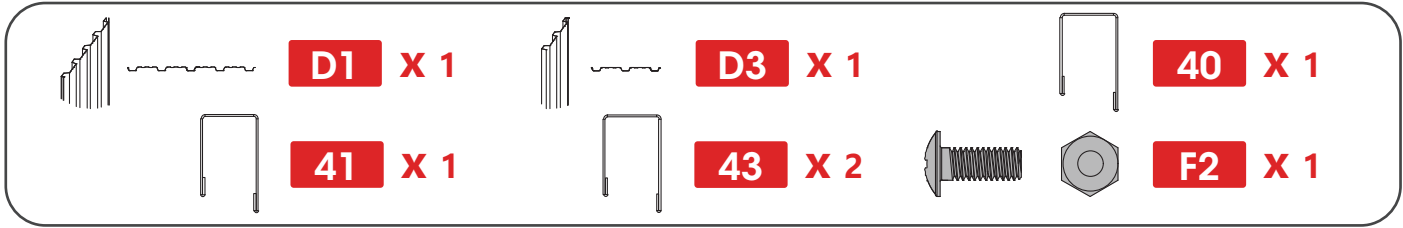

35



DX1 X 2

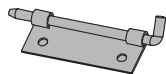

BL X 1

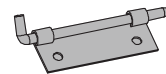

BR X 1

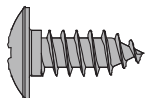

F1 X 9



S3 X 5

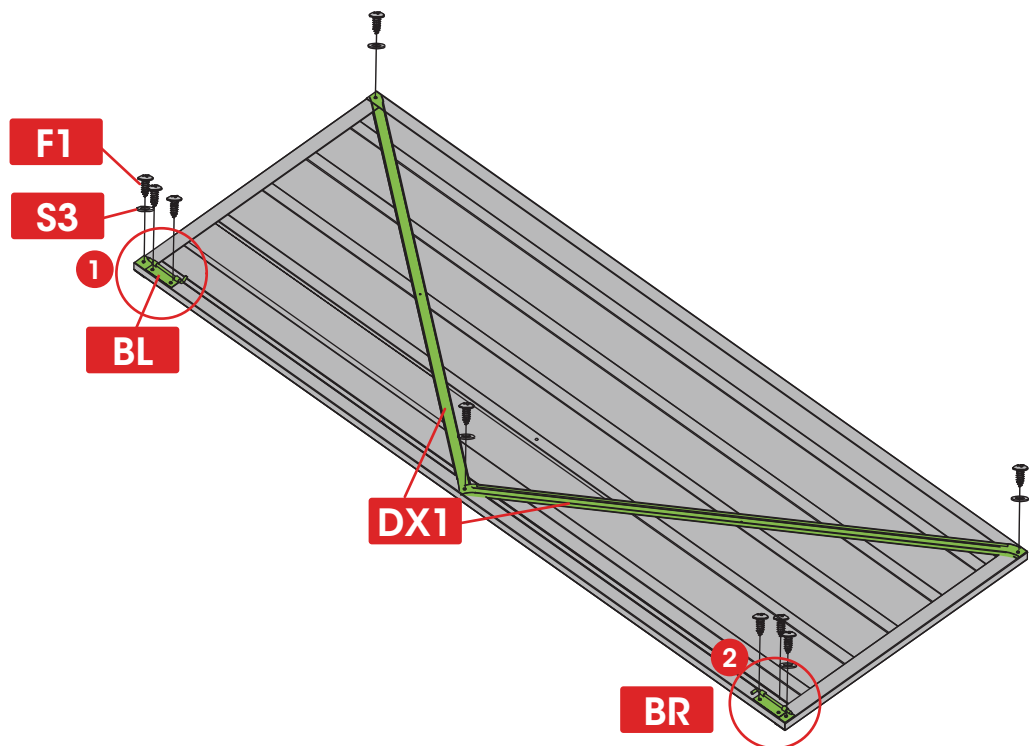
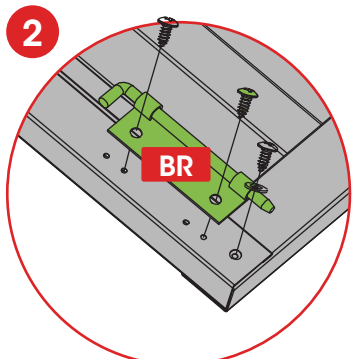
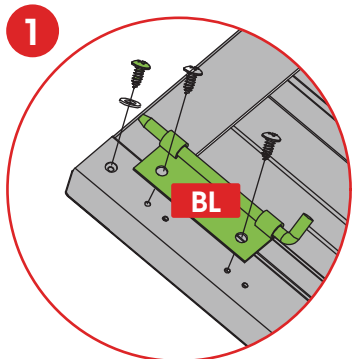

36

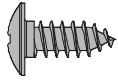

F1 X 12



S3 X 12

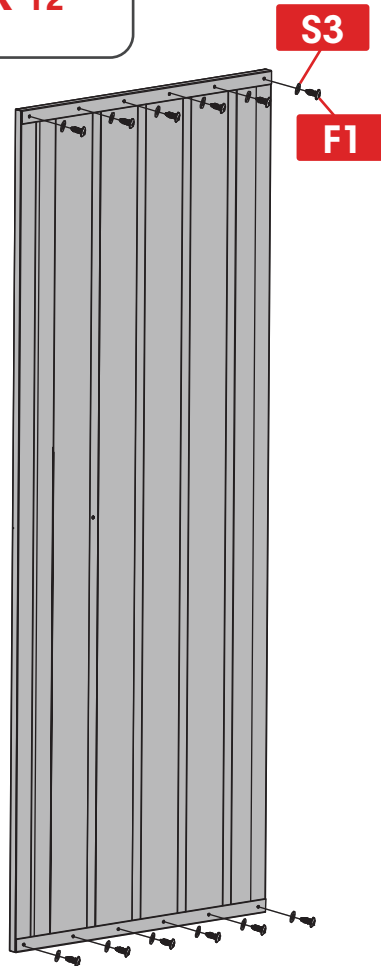

37

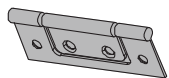

G4 X 6

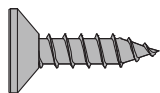

F4 X 12

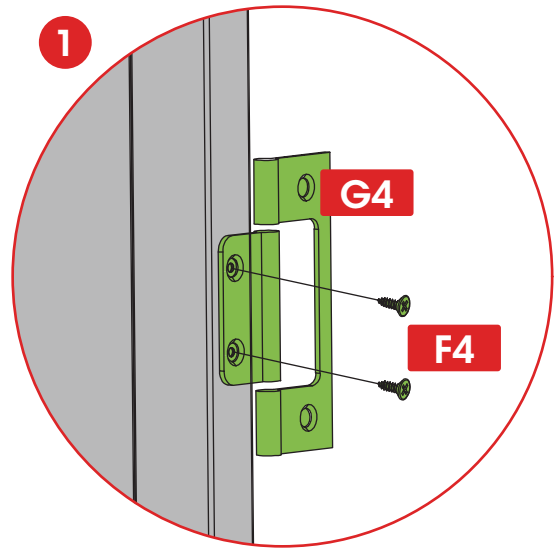
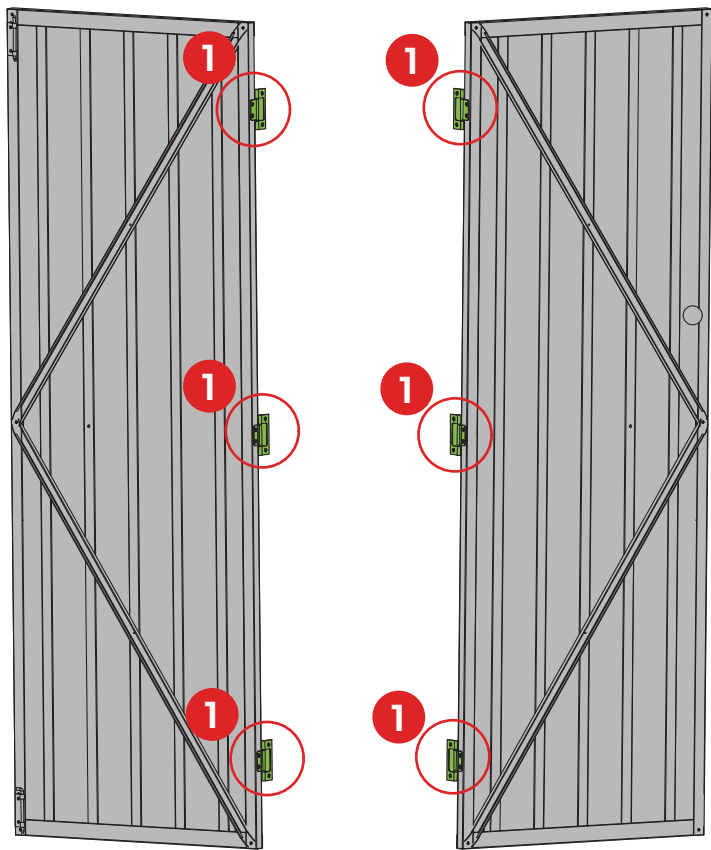

38

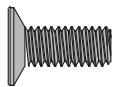

F3 X 12

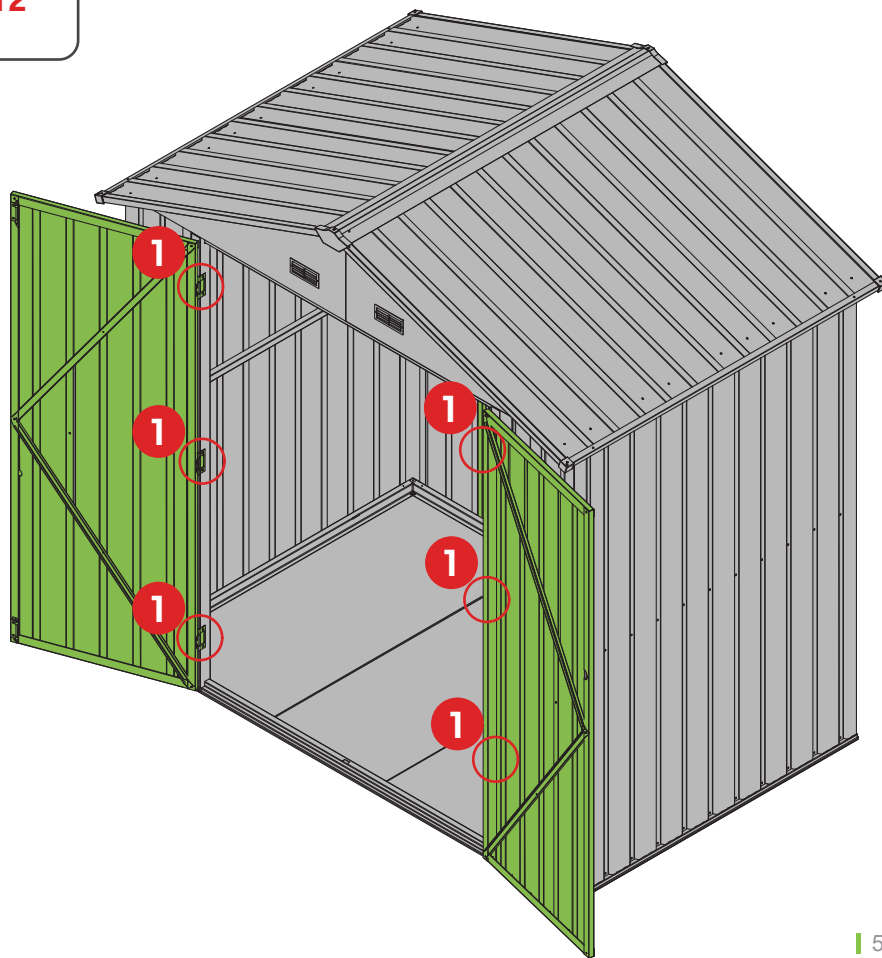
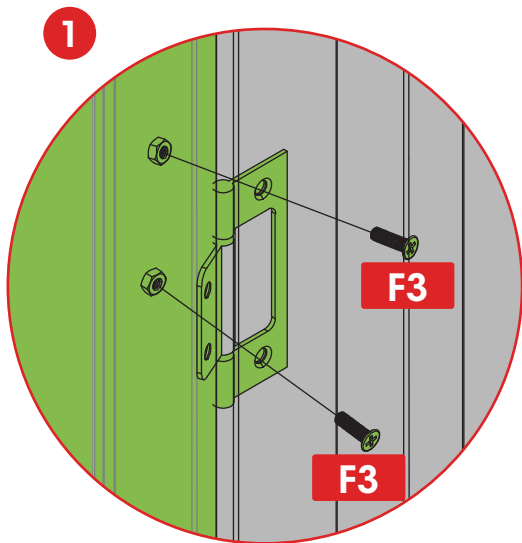

HELP CENTER

Question about your product? We're here to help. Visit us at:

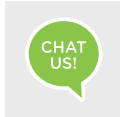

Chat Support

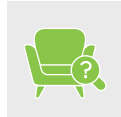

Product Inquiry

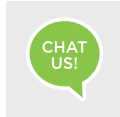

Orders FAQ



Product Assembly



Returns & Refunds

We Stand Behind the Quality of Their Furniture

If you have any issues with your item please let us know! We will always do our best to come up with a solution that you will be happy with. Please get in touch with our customer service team before returning the product. And pls do not throw the original box(es) if you have not finished assembling or confirmed no quality issues.

Length of return period:

Items can be returned within 30 days of purchase.

In the meanwhile, everything you purchased from us comes with a one-year warranty.

Who is responsible for the return shipping fee:

We will cover the return shipping fees if:

1. Your item has a manufacturing defect in its materials or workmanship. For example, torn wicker or misaligned screw holes. We will send you a prepaid shipping label after photos are sent.
2. Your item has been damaged in transit. For example, glass is broken or wicker is damaged. We will send you a prepaid shipping label after photos are sent.
3. You receive the wrong box(es) due to a warehouse error. We will send you a prepaid shipping label after photos are sent of the wrong SKU numbers on the outer box(es).
4. One or more boxes are lost in transit. We will send you a prepaid shipping label if you no longer want the item.

*However, we still hope to work with you for a better solution instead of a return. Please don't hesitate to contact our customer service team.

Customer will cover the return shipping fees if:

1. You don't like the product(s) after receiving the box(es).
2. You no longer need the product(s) but you have received the box(es).
3. You buy the product(s) by mistake but you have received the box(es).
4. Order/shipment cancellation failed and you have received the box(es).

Return Request

In order to get a full refund as described in this return policy, all items must be: (1) In a brandnew/unused condition, please provide photos before and after packaging.

(2) When returning, all accessories and parts are firmly packed in all original packaging.

If your return does not meet the requirements, you may not get a full refund.

When will I be refunded?

The refund is released once the goods have been returned to our warehouse.

What if the product is damaged/defective outside of the valid return period?

We want you to be a happy customer. Please reach out to us by email and we will come up with a solution to make sure you are satisfied.