



PROJECT SOURCE.

Project Source® is a registered trademark of LF, LLC. All rights reserved.

ITEM #0425433
0423825
0505891

FLUSHMOUNT CEILING FIXTURE

MODEL #FJ12-185
FJ12-186
FJ12-185-1

Français p. 8

Español p. 15

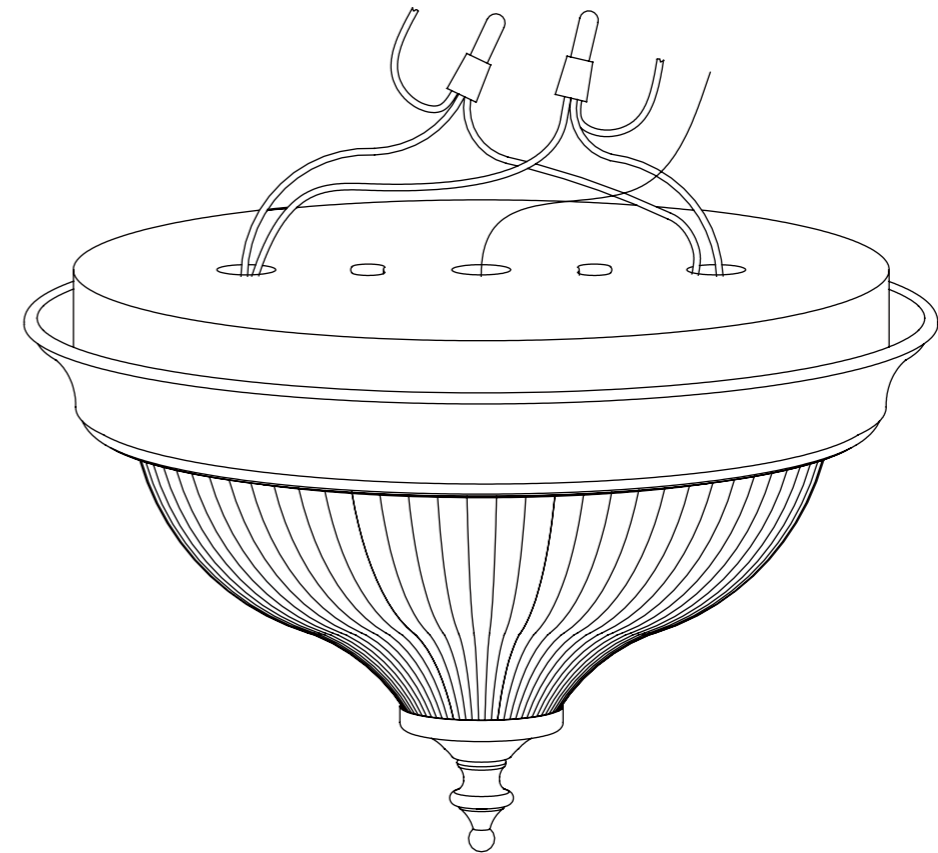

ATTACH YOUR RECEIPT HERE

Serial Number _____ Purchase Date _____



Intertek



Questions, problems, missing parts? Before returning to your retailer, call our customer service department at 1-866-389-8827, 8 a.m. - 6 p.m., EST, Monday -Thursday, 8 a.m. - 5 p.m., EST, Friday.

PACKAGE CONTENTS

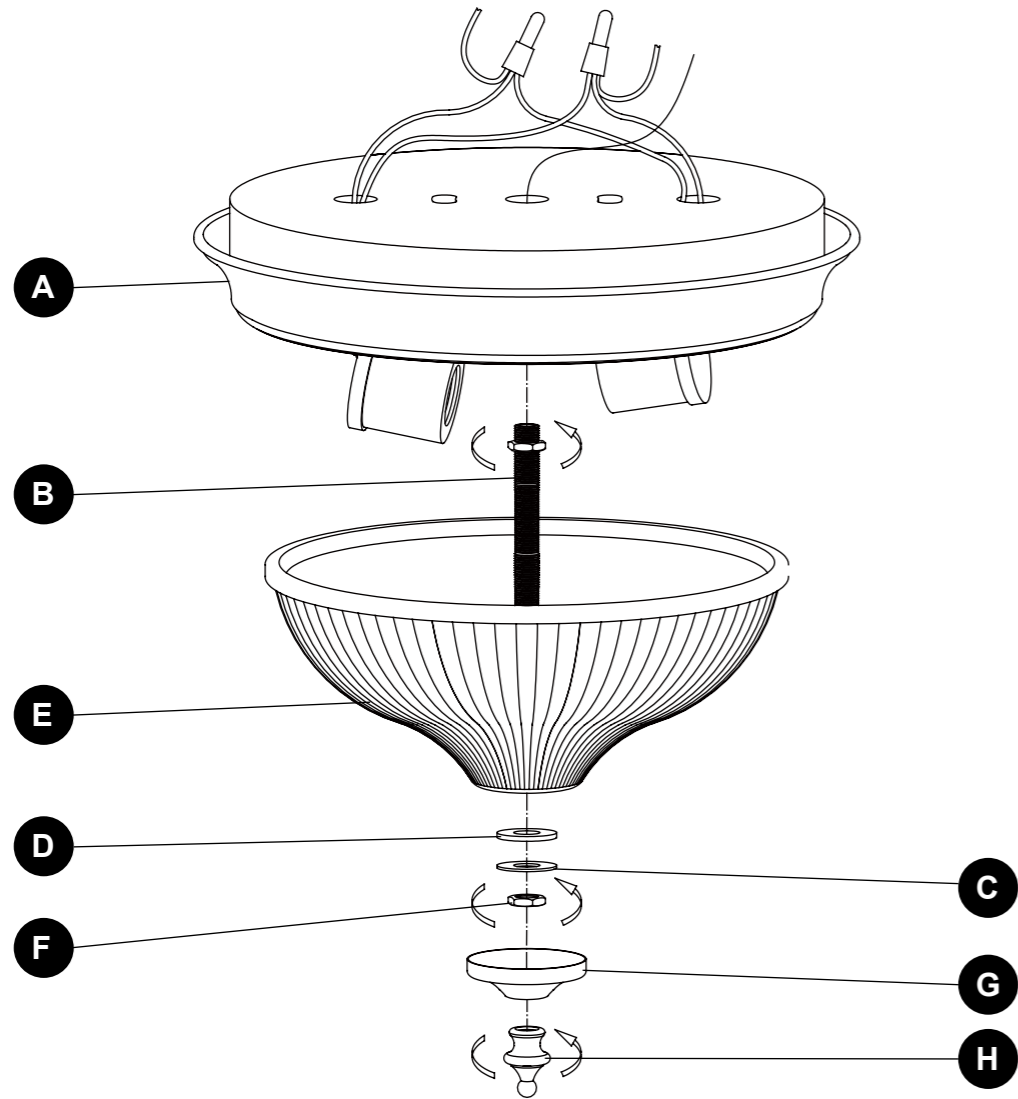

PART	DESCRIPTION	QUANTITY
A	Fixture	1
B	Threaded nipple	1
C	Washer (preassembled to Threaded nipple (B))	1
D	Rubber ring (preassembled to Threaded nipple (B))	1
E	Glass shade	1
F	Nut (preassembled to Threaded nipple (B))	1
G	Cap (preassembled to Threaded nipple (B))	1
H	Knob (preassembled to Threaded nipple (B))	1

HARDWARE CONTENTS (shown actual size)

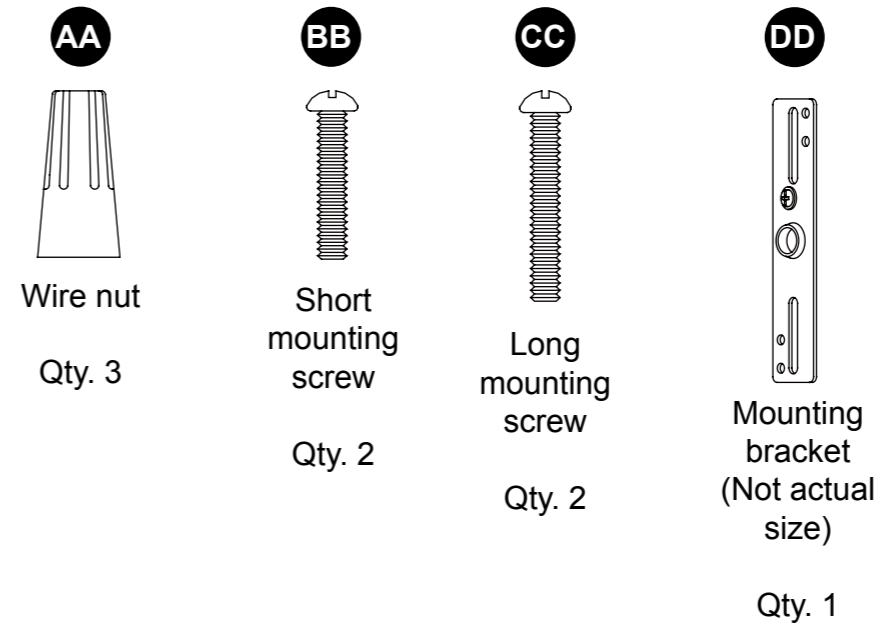

! SAFETY INFORMATION

Please read and understand this entire manual before attempting to assemble, operate or install the product.

! WARNING

- TURN OFF ELECTRICITY at main fuse box (or circuit breaker box) before beginning installation by removing fuse (or switching off circuit breaker).
- MINIMUM 90°C SUPPLY CONDUCTORS.

CAUTION

- CONSULT A QUALIFIED ELECTRICIAN TO ENSURE CORRECT BRANCH CIRCUIT CONDUCTOR.
- If in doubt about electrical installation, consult a licensed electrician.

PREPARATION

Before beginning assembly of product, make sure all parts are present. Compare parts with package contents list and hardware contents list. If any part is missing or damaged, do not attempt to assemble the product.

Estimated Assembly Time: 25 minutes



Tools Required for Assembly (not included): Flathead screwdriver, Phillips screwdriver, Pliers, Electrical tape, Wire cutters, Safety glasses.

Helpful Tools (not included): Wire strippers, Step ladder.

ASSEMBLY INSTRUCTIONS

1. Tighten the short mounting screws (BB) two full turns into the holes in the mounting bracket (DD). Then fasten mounting bracket (DD) onto the ceiling outlet box (not included) using long mounting screws (CC).

Hardware Used

BB Short mounting screw		x 2
CC Long mounting screw		x 2
DD Mounting bracket		x 1

2. Strip 3/4 in. of insulation from wire ends. Twist stripped ends together with pliers (not included), black to black (power) and white to white (neutral). Attach copper wire to ground wire. **Helpful hint:** If necessary, attach copper ground wire to grounded outlet box.

3. Attach wire nuts (AA). Tape wire nuts (AA) and wires together.

Hardware Used

AA Wire nut		x 3
--------------------	---	-----

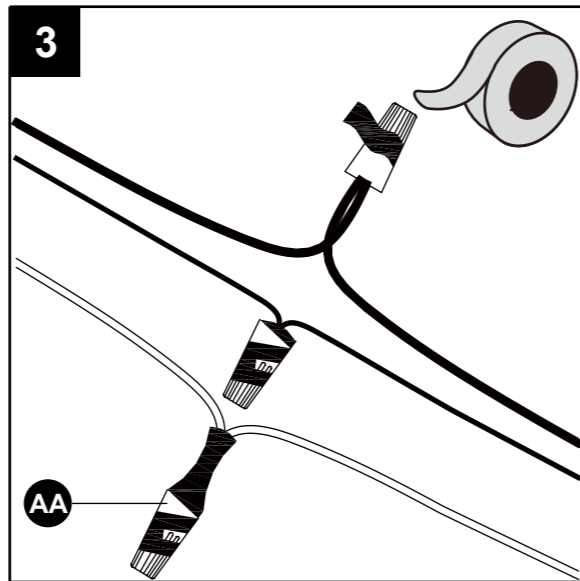
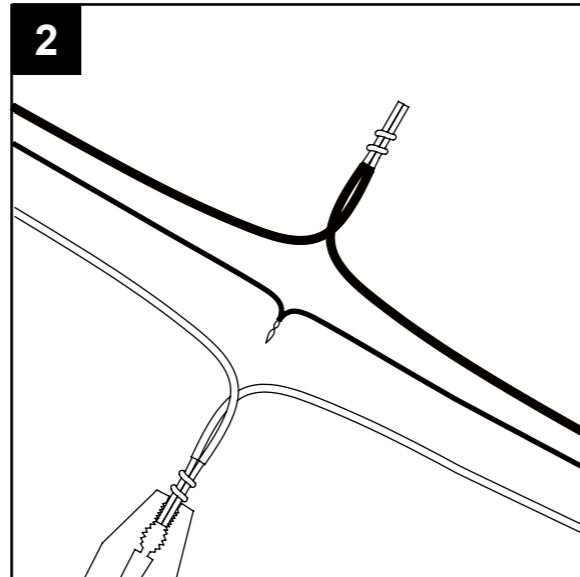
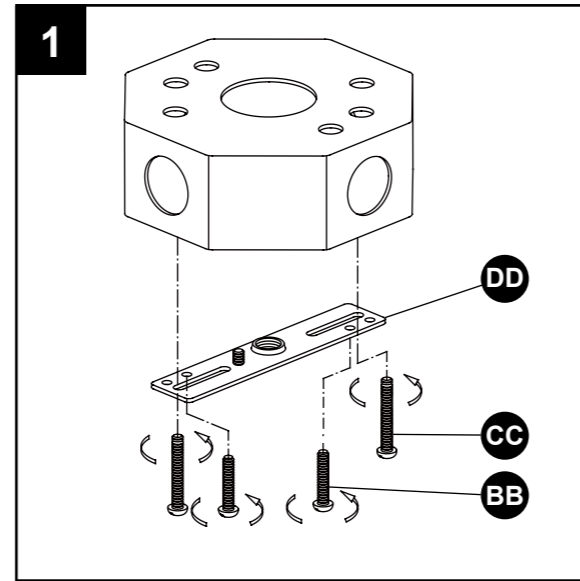

ASSEMBLY INSTRUCTIONS

4. Place the fixture (A) over the outlet box. Allow heads of short mounting screws (BB) to come out through the large ends of the key holes. Twist fixture (A) until heads of short mounting screws (BB) slide into narrow ends of key holes. Tighten short mounting screws (BB) to secure fixture (A).

Hardware Used

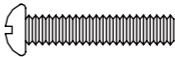
BB Short mounting screw		x 2
--------------------------------	---	-----

5. Install light bulbs (not included). Use two 40-watt max. standard-base bulbs or two 7-watt standard-base CFL bulbs.

6. Remove knob (H), cap (G), nut (F), rubber ring (D) and washer (C) from the threaded nipple (B). Tighten the threaded nipple (B) into the fixture (A). Place the glass shade (E), rubber ring (D) and washer (C) onto the threaded nipple (B). Tighten with nut (F) and place the cap (G) onto the threaded nipple (B). Tighten with knob (H).

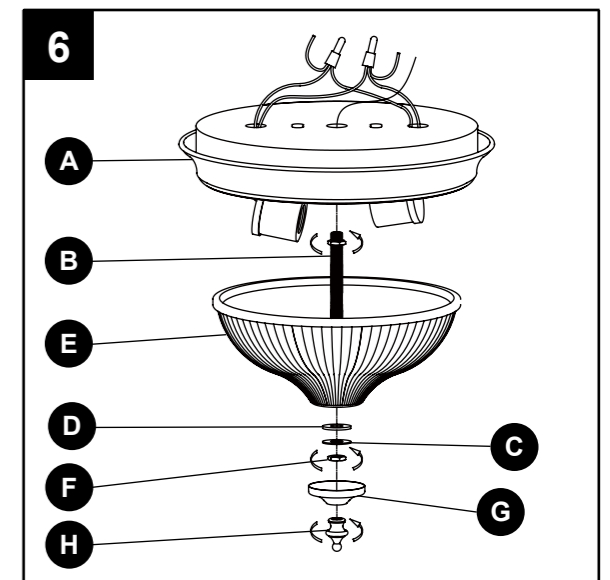
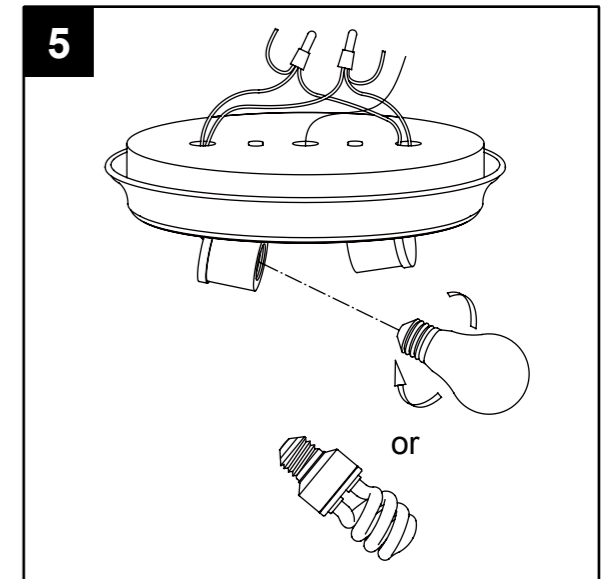
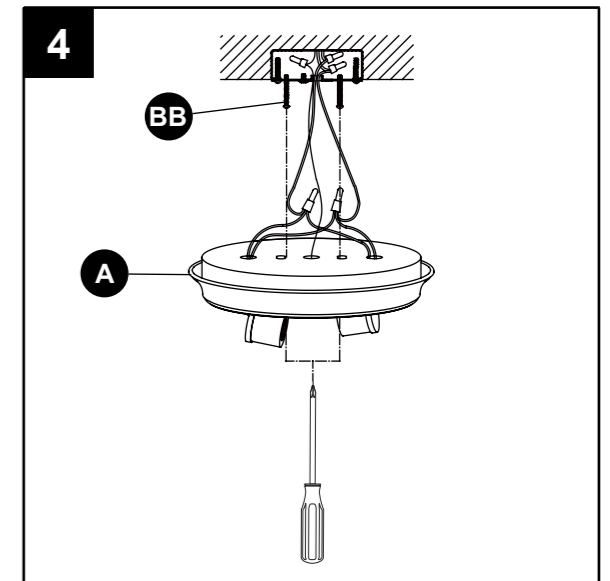

CARE AND MAINTENANCE

- Shut off main power supply before wiping product with damp cloth or window cleaner. Do not use abrasives.

TROUBLESHOOTING

PROBLEM	POSSIBLE CAUSE	CORRECTIVE ACTION
Bulb won't light.	<ol style="list-style-type: none"> 1. Bulb is burned out. 2. Power is off. 3. Faulty wire connection. 4. Faulty switch. 	<ol style="list-style-type: none"> 1. Replace light bulb. 2. Make sure power supply is on. 3. Check wiring. 4. Test or replace switch.
Fuse blows or circuit breaker trips when light is turned on.	Crossed wires or power wire is grounding out.	Check wire connections.

WARRANTY

The manufacturer warrants all of its lighting fixtures against defects in materials and workmanship for one (1) year from the date of purchase. If within this period the product is found to be defective in material or workmanship, the product must be returned, with a copy of the original sales receipt as proof of purchase in the original carton, to the place of purchase. The manufacturer will, at its option, repair, replace or refund the original purchase price to the consumer. This warranty does not cover fixtures becoming defective due to misuse, accidental damage, improper handling and/or installation and specifically excludes liability for direct, incidental or consequential damages. As some states do not allow exclusions or limitations on an implied warranty, the above exclusions and limitations may not apply to you. This warranty gives you specific legal rights, and you may have other rights that vary from state to state.

REPLACEMENT PARTS LIST

For replacement parts, call our customer service department at 1-866-389-8827, 8 a.m. - 6 p.m., EST, Monday - Thursday, 8 a.m. - 5 p.m., EST, Friday.

PART	DESCRIPTION	PART #
AA	Cap nut	375-022000
BB	Short mounting screw	109-042200
CC	Long mounting screw	109-042600
DD	Mounting bracket	139-103000

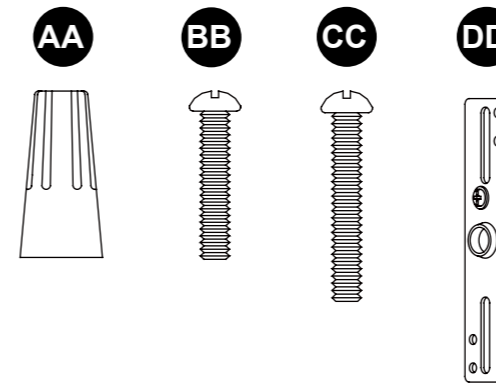

Printed in China

Project Source® is a registered trademark of LF, LLC. All rights reserved.