



Refrigerator

User manual

Free Standing Appliance

SAMSUNG

Contents

Safety information	4
Important safety symbols and precautions:	4
State of California Proposition 65 Warning (US only)	4
Critical installation warnings	5
Installation cautions	7
Critical usage warnings	7
Usage cautions	11
Cleaning cautions	12
Critical disposal warnings	13
1. Regulatory Notice	14
Installation	16
Refrigerator at a glance	16
Door removal for entrance	18
Step-by-step installation	26
Operations	35
Feature panel	35
Samsung Smart Home	42
SMART GRID Function (Demand Response)	46
Special features	51
Maintenance	56
Handle and care	56
Cleaning	60
Replacement	60
Troubleshooting	64
General	64
Samsung Smart Home	67
Smart Grid	68

Warranty (USA) 69

WARRANTY ON SAMSUNG REFRIGERATOR 69

Warranty Information (CANADA) 72

If your refrigerator needs service 72

Limited Warranty for Original Purchaser 72

Obligation to the Original Owner 72

Exclusions of the Warranty 73

Open Source Announcement 74

Safety information

- Before using your new Samsung Refrigerator, please read this manual thoroughly to ensure that you know how to operate the features and functions that your new appliance offers safely and efficiently.
- This appliance is not intended for use by persons (including children) with reduced physical, sensory, or mental capabilities, or those who lack experience and knowledge, unless they have been given supervision or instruction concerning the use of the appliance by a person responsible for their safety.
- Because the following instructions cover various models, the characteristics of your refrigerator may differ slightly from the refrigerator described in this manual.
- If you have any question, contact us at 1-800-SAMSUNG or find help and information online at www.samsung.com.
- R-600a or R-134a is used as a refrigerant. Check the compressor label on the rear of the appliance or the rating label inside the fridge to see which refrigerant is used for your refrigerator. If this product contains flammable gas (Refrigerant R-600a), contact your local authority in regard to safe disposal of this product.
- It is hazardous for anyone other than an Authorised Service Person to service this appliance.

Important safety symbols and precautions:

Please follow all safety instructions in this manual. This manual uses the following safety symbols.

WARNING

Hazards or unsafe practices that may result in **severe personal injury, property damage, and/or death.**

CAUTION

Hazards or unsafe practices that may result in **severe personal injury and/or property damage.**

NOTE

Useful information that helps users understand or benefit from the refrigerator.

These warning signs are here to prevent injury to you and others.

Please follow them carefully.

After reading this section, keep it in a safe place for future reference.

State of California Proposition 65 Warning (US only)

WARNING : This product contains chemicals known to the State of California to cause cancer and birth defects or other reproductive harm.

Critical installation warnings

WARNING

- Do not install the refrigerator in a damp location or place where it may come in contact with water.
 - Deteriorated insulation on electrical parts may cause an electric shock or fire.
- Do not place this refrigerator in direct sunlight or expose it to the heat from stoves, room heaters, or other appliances.
- Do not plug several appliances into the same multiple power strip. The refrigerator should always be plugged into its own individual electrical outlet which has a voltage rating that matches the voltage listed on the refrigerator's rating plate.
 - This provides the best performance and also prevents overloading of house wiring circuits, which could overheat the wires and cause a fire hazard.
- If the wall socket is loose, do not insert the power plug.
 - There is a risk of electric shock or fire.
- Do not use a power cord that has cracks or abrasion damage along its length or at either end.
- Do not bend the power cord excessively or place heavy objects on it.
- Do not pull or excessively bend the power cord.
- Do not twist or tie the power cord.
- Do not hook the power cord over a metal object, place a heavy object on the power cord, insert the power cord between objects, or push the power cord into the space behind the appliance.
- When moving the refrigerator, be careful not to roll over or damage the power cord.
 - This may result in an electric shock or fire.
- Never unplug your refrigerator by pulling on the power cord. Always grip the plug firmly and pull straight out from the outlet.
 - Damage to the cord may cause a short-circuit, fire, and/or electric shock.
- Do not store explosive substances such as aerosol cans with a flammable propellant in this appliance.
- Do not install this appliance near a heater or flammable material.
- Do not install this appliance in a location where gas may leak.
 - This may result in an electric shock or fire.
- This refrigerator must be properly located and installed in accordance with the instructions in this manual before you use it.
- Connect the power plug in the proper position with the cord hanging down.
 - If you connect the power plug upside down, the wire can get cut off and cause a fire or electric shock.

Safety information

- Make sure that the power plug is not crushed or damaged by the back of the refrigerator.
- Keep the packing materials out of reach of children.
 - There is a risk of death from suffocation if a child puts the packing materials on his or her head.
- The appliance must be positioned so that the plug is accessible after installation.
 - Failing to do so may result in an electric shock or fire due to electric leakage.
- Do not install this appliance in a humid, oily or dusty location, or in a location exposed to direct sunlight or to water (rain drops).
 - Deteriorated insulation on electrical parts may cause an electric shock or fire.
- If large amounts of dust or water enter the refrigerator, disconnect the power plug and contact your Samsung Electronics service center.
 - Otherwise there is a risk of fire.
- Do not stand on top of the appliance or place objects (such as laundry, lighted candles, lighted cigarettes, dishes, chemicals, metal objects, etc.) on the appliance.
 - This may result in an electric shock, fire, problems with the product, or injury.
- You need to remove all the protective plastic film before you initially plug the product in.
- Children should be supervised to ensure that they do not play with the snap rings used for door adjustment or the water tube clips.
 - There is risk of death by suffocation if a child swallows a snap ring or water tube clip. Keep the snap rings and water tube clips out of children's reach.
- The refrigerator must be safely grounded.
 - Always make sure that you have grounded the refrigerator before attempting to investigate or repair any part of the appliance. Power leakages can cause severe electric shock.
- Never use gas pipes, telephone lines, or other potential lightning attractors as an electrical ground.
 - You must ground the refrigerator to prevent any power leakages or electric shocks caused by current leakage from the refrigerator.
 - This may result in an electric shock, fire, explosion, or problems with the product.
 - Improper use of the grounding plug can result in a risk of electric shock. If it is necessary to use an extension cord, use only a 3-wire extension cord that has a 3-blade grounding plug and a 3-slot receptacle that will accept the plug on the appliance. The marked rating of the extension cord should be AC 115-120 V, 10 A, or more. If a grounding adapter is used, make sure the receptacle box is fully grounded.

-
- Plug the power plug into the wall socket firmly. Do not use a damaged power plug, damaged power cord, or loose wall socket.
 - This may result in an electric shock or fire.
 - If the power cord is damaged, have it replaced immediately by the manufacturer or one of its service agents.
 - Only a qualified technician or service company should be allowed to change the fuse in the refrigerator.
 - Failing to do so may result in an electric shock or personal injury.

Installation cautions

CAUTION

- Allow sufficient space around the refrigerator and install it on a flat surface.
 - Keep the ventilation space in the appliance enclosure or mounting structure clear of obstructions.
- After you have installed the refrigerator and turned it on, allow the appliance to stand for 2 hours before loading it with food.
- We strongly recommend you have a qualified technician or service company install the refrigerator.
 - Failing to do so may result in an electric shock, fire, explosion, problems with the product, or injury.
- Overloading one door may make the refrigerator fall, causing physical injury.

Critical usage warnings

WARNING

- Do not insert the power plug into a wall socket with wet hands.
 - This may result in an electric shock.
- Do not store articles on the top of the appliance.
 - When you open or close the door, the articles may fall and cause personal injury and/or material damage.
- Do not insert hands, feet or metal objects (such as chopsticks, etc.) into the bottom or the back of the refrigerator.
 - This may result in an electric shock or injury.
 - Any sharp edges may cause a personal injury.

Safety information

- Do not touch the inside walls of the freezer or products stored in the freezer with wet hands.
 - This may cause frostbite.
- Do not put a container filled with water on the refrigerator.
 - If spilled, there is a risk of fire or electric shock.
- Do not keep volatile or flammable objects or substances (benzene, thinner, propane gas, alcohol, ether, LP gas, and other such products) in the refrigerator.
 - This refrigerator is for storing food only.
 - This may result in fire or explosion.
- Children should be supervised to ensure that they do not play with the appliance.
 - Keep fingers out of "pinch point" areas. Clearances between the doors and cabinet are necessarily small. Be careful when you open the doors if children are in the area.
- Do not let children hang on the door or door bins. A serious injury may occur.
- Do not let children go inside the refrigerator. They could become trapped.
- Do not insert your hands into the area under the appliance.
 - Any sharp edges may cause personal injury.
- Do not store pharmaceutical products, scientific materials, or temperature sensitive products in the refrigerator.
 - Products that require strict temperature controls must not be stored in the refrigerator.
- Do not place or use electrical appliances inside the refrigerator/freezer, unless they are of a type recommended by the manufacturer.
- If you smell smoke, pull out the power plug immediately, and then contact your Samsung Electronics service center.
- If large amounts of dust or water enter the refrigerator, disconnect the power plug and contact your Samsung Electronics service center.
 - Otherwise there is a risk of fire.
- Do not let children step on a drawer.
 - The drawer may break and cause them to slip.
- Do not leave the doors of the refrigerator open while the refrigerator is unattended and do not let children enter the refrigerator.
- Do not allow babies or children go into a drawer.
 - It can cause death from suffocation by entrapment or personal injury.
- Do not overfill the refrigerator with food.
 - When you open the door, an item may fall out and cause personal injury or material damage.
- Do not spray volatile material such as insecticide onto the surface of the appliance.
 - As well as being harmful to humans, it may also result in an electric shock, fire, or problems with the product.



- Never put fingers or any objects into the water dispenser outlet, ice chute, or ice maker bucket.
 - It may cause a personal injury or material damage.
- Do not use or place any substances sensitive to temperature such as flammable sprays, flammable objects, dry ice, medicine, or chemicals near or inside the refrigerator.
- Do not use a hair dryer to dry the inside of the refrigerator. Do not place a lighted candle in the refrigerator to remove bad odors.
 - This may result in an electric shock or fire.
- Fill the water tank, ice tray, and water cubes with potable water only (tap water, mineral water, or purified water).
 - Do not fill the tank with tea, juice, or a sports drink. They can damage the refrigerator.
- Do not stand on top of the appliance or place objects (such as laundry, lighted candles, lighted cigarettes, dishes, chemicals, metal objects, etc.) on the appliance. This may result in an electric shock, fire, problems with the product, or injury. Do not put a container filled with water on the appliance.
 - If spilled, there is a risk of fire or electric shock.
- Do not use mechanical devices or any other means to accelerate the defrosting process, other than those recommended by the manufacturer.
- Do not damage the refrigerant circuit.
- Never stare directly at the UV LED lamp for long periods of time.
 - This may result in eye strain due to the ultraviolet rays.
- Do not put a fridge shelf into the refrigerator upside down. The shelf stopper will not work.
 - The glass shelf could fall and cause personal injury.
- Keep fingers out of "pinch point" areas. Clearances between the doors and cabinet are necessarily small. Be careful when you open the doors if children are in the area.
- If a gas leak is detected, avoid any naked flames or potential sources of ignition, and air the room in which the appliance is standing for several minutes.
 - Do not touch the appliance or power cord.
 - Do not use a ventilating fan.
 - A spark may result in an explosion or fire.
- Use only the LED Lamps provided by the manufacturer or its service agents.
- Bottles should be stored tightly together so that they do not fall over or out.
- This product is intended only for the storage of food in a domestic environment.
- Never put fingers or any objects into the water dispenser outlet, ice chute, or ice maker bucket.
 - This can cause a personal injury or material damage.



Safety information

- Do not attempt to repair, disassemble, or modify the refrigerator yourself.
 - Unauthorized modifications can cause safety problems. To reverse an unauthorized modification, we will charge the full cost of parts and labor.
- Do not use any fuse (such as cooper, steel wire, etc.) other than a standard fuse.
- If your refrigerator needs to be repaired or reinstalled, contact your nearest service center.
 - Failing to do so may result in an electric shock, fire, problems with the product, or injury.
- If the interior or exterior LED lamp has gone out, contact your nearest Samsung service center.
- If the refrigerator emits a burning smell or smoke, unplug the refrigerator immediately and contact a Samsung service center.
 - Failing to do so may result in an electric or fire hazards.
- Pull the power plug out of the socket before changing the interior lamps of the refrigerator.
 - Otherwise, there is a risk of electric shock.
- If you experience difficulty changing a non-LED light, contact a Samsung service center.
- If the product is equipped with LED lamps, do not disassemble the Lamp Covers and LED lamps yourself.
 - Contact a Samsung service center.
- Plug the power plug into the wall socket firmly.
- Do not use a damaged power plug, damaged power cord, or loose wall socket.
 - This may result in an electric shock or fire.

Usage cautions

CAUTION

- Do not re-freeze frozen foods that have thawed completely. Do not place carbonated or fizzy drinks in the freezer compartment. Do not put bottles or glass containers in the freezer.
 - When the contents freeze, the glass may break and cause personal injury.
- Use only the ice maker provided with the refrigerator.
- To get the best performance from the product:
 - Do not place food too close to the vents at the rear of the refrigerator as this can obstruct free air circulation in the refrigerator compartment.
 - Wrap food up properly or place it in airtight containers before putting it into the refrigerator.
 - Do not put glass bottles or carbonated beverages into the freezer. They can freeze and break. Broken beverage containers can cause injury.
 - Please observe maximum storage times and expiration dates of frozen goods.
- Do not put glass containers or bottles or carbonated beverages into the freezer.
 - The container may freeze and break, and this may result in injury.
- Service Warranty and Modification.
 - Any changes or modifications performed by a 3rd party on this finished appliance are not covered under Samsung warranty service, nor is Samsung responsible for safety issues that result from 3rd party modifications.
- Do not block the air vents inside the refrigerator.
 - If the air vents are blocked, especially with a plastic bag, the refrigerator can be over cooled. If a cooling period lasts too long, the water filter may break and cause water leakage.
- If the refrigerator is disconnected from the power supply, you should wait for at least five minutes before plugging it back in.
- If large amounts of water enter the refrigerator, pull out the power plug and contact a Samsung service center.
- Do not strike or apply excessive force to any glass surface.
 - Broken glass may result in a personal injury and/or property damage.
- Fill the water tank and ice cube trays with potable water only (tap water, mineral water, or purified water).
 - Do not fill the tank with tea, juice, or a sports drink. They can damage the refrigerator.
- If the refrigerator is flooded, shut off the power to the refrigerator and contact your nearest Samsung service center.
 - There is a risk of electric shock or fire.

Safety information

- Do not keep vegetable oil in your refrigerator's door bins. The oil can solidify, making it foul-tasting and difficult to use. In addition, the open container can leak and the leaked oil can cause the door bin to crack. After opening an oil container, it is best to keep the container in a cool and shaded place such as a cupboard or pantry.
 - Examples of vegetable oil: olive oil, corn oil, grape-seed oil, etc.

Cleaning cautions

CAUTION

- Do not spray water directly on the inside or outside the refrigerator.
 - There is a risk of fire or electric shock.
- Do not use a hair dryer to dry the inside of the refrigerator.
- Do not place a lighted candle in the refrigerator to remove bad odors.
 - This may result in an electric shock or fire.
- Do not spray cleaning products directly on the display.
 - Printed letters on the display may come off.
- If any foreign substance such as water has entered the appliance, unplug the power plug and contact your nearest service center.
 - Failing to do so may result in an electric shock or fire.
- Use a clean, dry cloth to remove any foreign matter or dust from the power plug blades. Do not use a wet or damp cloth when cleaning the plug.
 - Otherwise, there is a risk of fire or electric shock.
- Do not clean the appliance by spraying water directly onto it.
- Do not use benzene, thinner, or Clorox (bleach) to clean the refrigerator.
 - They may damage the surface of the appliance and may cause a fire.
- Never put fingers or any objects into the dispenser outlet.
 - This can cause a personal injury or material damage.
- Before cleaning or performing maintenance, unplug the appliance from the wall socket.
 - Failing to do so may result in an electric shock or fire.
- Use a clean sponge or soft cloth and a mild detergent in warm water to clean the refrigerator.
- Do not use abrasive or harsh cleansers such as window sprays, scouring cleansers, flammable fluids, muriatic acid, cleaning waxes, concentrated detergents, bleaches, or cleansers containing petroleum products on exterior surfaces (doors and cabinet), plastic parts, door and interior liners, and gaskets.
 - These can scratch or damage the material.

- Do not clean glass shelves or covers with warm water when they are cold. Glass shelves and covers may break if exposed to sudden temperature changes or impacts such as bumping or dropping.

Critical disposal warnings

WARNING

- **DANGER** : Risk of child entrapment. Before you throw away your old refrigerator or freezer:
 - Take off the doors and door latch.
 - Leave the shelves in place so that children cannot easily climb inside.
 - Children trapped inside a refrigerator can hurt themselves or suffocate to death.
- Please dispose of the packaging material from this product in an environmentally friendly manner.
- Ensure that none of the pipes on the back of the refrigerator are damaged prior to disposal.
- R-600a or R-134a is used as a refrigerant. Check the compressor label on the rear of the appliance or the rating label inside the fridge to see which refrigerant is used for your refrigerator. If this refrigerator contains flammable gas (Refrigerant R-600a), contact your local authority in regard to the safe disposal of this product.
- When disposing of this refrigerator, remove the door/door seals and door latch so that small children or animals cannot become trapped inside. Children should be supervised to ensure that they do not play with the appliance.
 - If trapped inside, the child could be injured or suffocate to death.
- Cyclopentane is used in the insulation. The gases in the insulation material require a special disposal procedure. Please contact your local authorities in regard to the environmentally safe disposal of this product.
- Keep all packaging materials well out of the reach of children, as packaging materials can be dangerous to children.
 - If a child places a bag over his or her head, the child could suffocate.

Safety information

1. Regulatory Notice

1.1 FCC Notice

FCC CAUTION:

Any changes or modifications not expressly approved by the party responsible for compliance could void the user's authority to operate the equipment.

Contains Transmitter Module FCC ID: A3LSWL-CQ52

This device complies with Part 15 of FCC Rules. Operation is Subject to the following two conditions:

- (1) This device may not cause harmful interference, and
- (2) This device must accept any interference received including interference that cause undesired operation.

For products available in the US and Canadian markets, only channels 1~11 are available. You cannot select other channels.

FCC STATEMENT:

This equipment has been tested and found to comply within the limits for a Class B digital device, pursuant to part 15 of the FCC Rules. These limits are designed to provide reasonable protection against harmful interference in a residential installation.

This equipment generates, uses, and can radiate radio frequency energy and, if not installed and used in accordance with the instructions, may cause harmful interference to radio communications. However, there is no guarantee that interference will not occur in a particular installation. If this equipment does cause harmful interference to radio or television reception, which can be determined by turning the equipment off and on, the user is encouraged to try to correct the interference by one or more of the following measures:

- Reorient or relocate the receiving antenna
- Increase the separation between the equipment and receiver
- Connect the equipment to an outlet that is on a different circuit than the receiver.
- Consult the dealer or an experienced radio/TV technician for help.

FCC RADIATION EXPOSURE STATEMENT:

This equipment complies with FCC radiation exposure limits set forth for an uncontrolled environment.

This equipment should be installed and operated so there is at least 8 inches (20 cm) between the radiator and your body. This device and its antennas must not be co-located or operated in conjunction with any other antenna or transmitter except in accordance with FCC multi-transmitter product procedures.



1.2 IC Notice

Contains Transmitter Module IC: 649E-SWLCQ52

The term "IC" before the radio certification number only signifies that Industry Canada technical specifications were met. Operation is subject to the following two conditions : (1) this device may not cause interference, and (2) this device must accept any interference, including interference that may cause undesired operation of the device.

This Class B digital apparatus complies with Canadian ICES-003.

Cet appareil numérique de la classe B est conforme à la norme NMB-003 du Canada.

For products available in the US and Canadian markets, only channels 1~11 are available. You cannot select other channels.

IC RADIATION EXPOSURE STATEMENT:

This equipment complies with IC RSS-102 radiation exposure limits set forth for an uncontrolled environment. This equipment should be installed and operated so there is at least 8 inches (20 cm) between the radiator and your body. This device and it's antennas must not be co-located or operated in conjunction with any other antenna or transmitter except in accordance with FCC multi-transmitter product procedures.

SAVE THESE INSTRUCTIONS

Safety Information



Installation

Follow these instructions carefully to prevent accidents and to ensure the proper installation of this refrigerator.

⚠ WARNING

- Use the refrigerator only for its intended purpose as described in this manual.
- Any servicing must be performed by a qualified technician.
- Dispose of the product packaging material in compliance with the local regulations.
- To prevent electric shock, unplug the power cord before servicing.

Refrigerator at a glance

📖 NOTE

The images of parts in this manual and the actual provided component parts of the refrigerator may differ, depending on the model and your country.

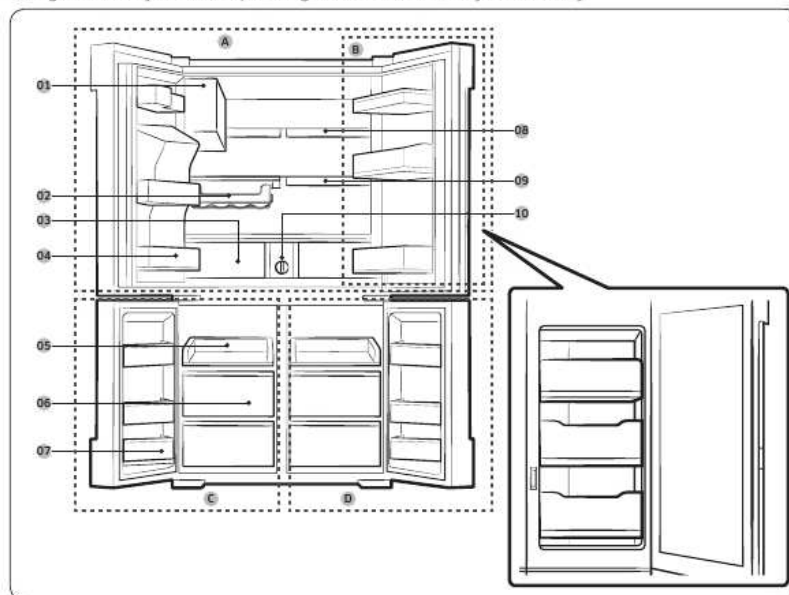

-
- 01 Auto Ice Maker
 - 02 Wine Rack *
 - 03 EZ Fresh Vegetable & Fruit Drawers
 - 04 Fridge Multi-Purpose Guard
 - 05 Easy Slide-Shelf
 - 06 Dry Food and Meat Storage Drawers
 - 07 Freezer door Bins
 - 08 Fixed Shelf
 - 09 Quick Space Shelf
 - 10 Water filter
- A. Fridge
B. Showcase Door *
C. Freezer
D. Flex Zone

* applicable models only

CAUTION

- When the inner case is open, do not open the show case. The show case is likely to be pushed back and may be damaged.
- When closing the show case, make sure the show case is closed properly. If you close the show case properly, you will hear a clicking sound.

NOTE

- For energy efficiency, keep all shelves, drawers, and baskets in their original positions.
- When closing the door, make sure the vertical hinged section is in the correct position to avoid scratching the other door.
- If the vertical hinged section is reversed, put it back into the correct position, and then close the door.
- Moisture may form at times on the vertical hinged section.
- If you close a door by force, the other door may open.
- When the door opens, the interlock switch automatically disables the auger motor of the ice maker for safety reasons.
- If the internal or external LED lamp is out of order, contact a local Samsung service center.

Installation

Installation

Door removal for entrance

If the refrigerator cannot pass through the entrance to your home or kitchen due to its size, follow these instructions to remove and then re-install the refrigerator's doors. If you do not need to remove the doors, go to page 26 for the installation instructions.

Tools required (not provided)

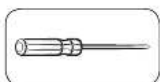

Phillips screwdriver

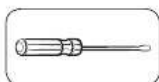

Flat-head screwdriver

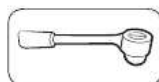

Socket wrench (10 mm)

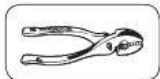

Pliers



Allen wrench (4 mm)



Allen wrench (5 mm)

Detaching the fridge doors

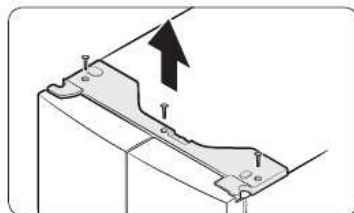

1. With the door closed, use a Phillips screwdriver to remove the screws (x3) from the top cover. Pull up and remove the top cover with the connectors.

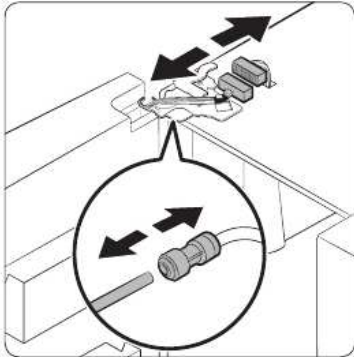

2. Disconnect the two wire connectors on the left door. The position of the connectors differs with the model.

⚠ CAUTION

- Do not remove both doors simultaneously. Make sure to remove one door at a time. Otherwise, any of the doors may fall and cause physical injury.
 - Make sure the refrigerator is off before disconnecting the connectors.
3. Disconnect the water tube from the coupler on the left door as shown.
 4. Gently draw up the clamp in several steps. To prevent finger injuries, do not apply a sudden force to the clamp.

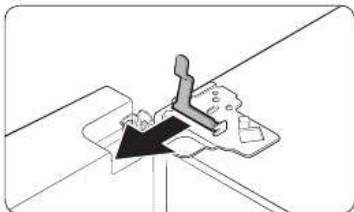
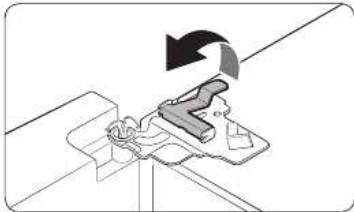

5. Pull up the clamp to remove.

Installation

Installation

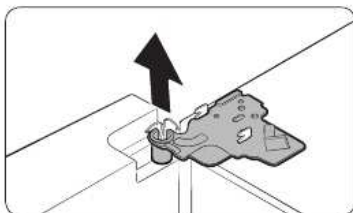

6. Open the door 90 degrees. While holding the door, pull up and remove the top hinge. Be careful not to damage the connector wires when you remove the hinge.

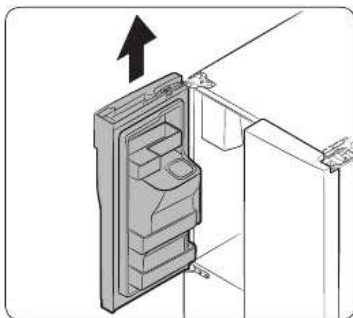

7. Gently pull up the door vertically to remove. Do not apply excessive force to the door. The door may fall, causing physical injury.
8. Lay the door down on a flat surface.
9. Repeat the steps above for the other door, except for Step 3. There is no water tube on the right side door.

Detaching the freezer doors

⚠ CAUTION

- Be sure to remove the fridge doors before removing the freezer doors.
- Use caution when disconnecting the bottom connectors.

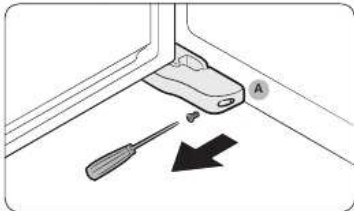

1. With the freezer door open, use a Phillips screwdriver to remove the screw holding the **cover (A)** of the adjustable leg.

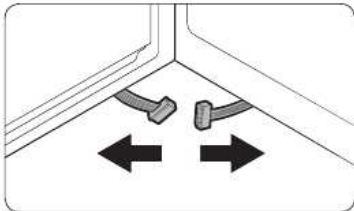

2. Disconnect the wire connectors.



3. Locate the hinge shaft. While holding the door with one hand, use a flat-head screwdriver or wrench to press the shaft down. Make sure to hold the door to prevent the door from falling.

Installation

Installation

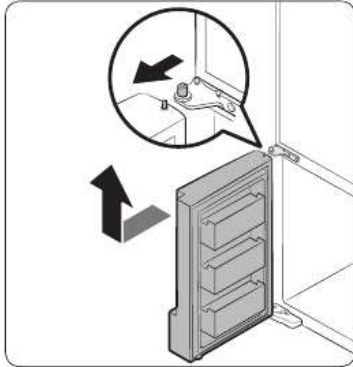

4. To prevent contact with the middle hinge, slightly tilt the door to the front, and then lift it up to remove.
5. Repeat the steps above for the other door.

Re-attaching the freezer doors

CAUTION

- Before re-attaching the doors, make sure all the electrical connectors are properly connected.
- The freezer doors must be re-attached before the fridge doors.
- Be careful not to damage or step on the wires during this process.

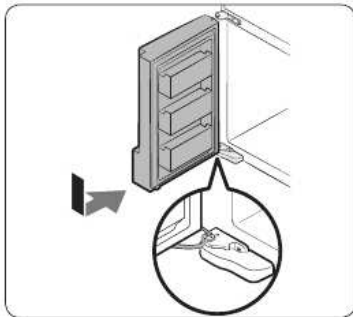

1. Insert the freezer door into the bottom hinge while pushing the freezer door in the direction of the arrow.

CAUTION

- Be careful not to damage or step on the wires during this process.

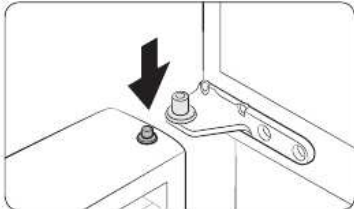

2. While pressing the hinge shaft down, position the door so that the hinge shaft is below the shaft hole in the middle hinge. Release the hinge shaft so that it enters the shaft hole.

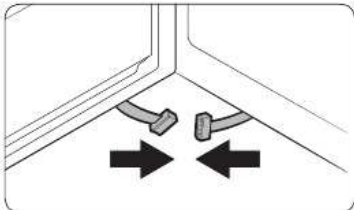

3. With the door open, connect the bottom connectors in the direction of the arrows.

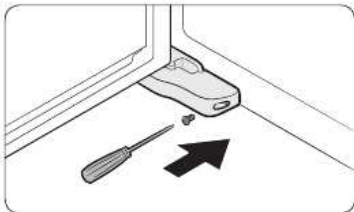

4. Attach the levelling foot cover using a Phillips screwdriver. Be careful not to damage or step on the connectors.
5. Repeat the steps above for the other door.

Installation

Re-attaching the fridge doors

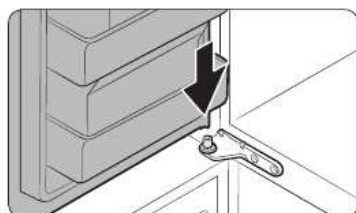

1. While holding the door open by more than 90 degrees, insert the shaft on the middle hinge into the hole on the bottom of the door.

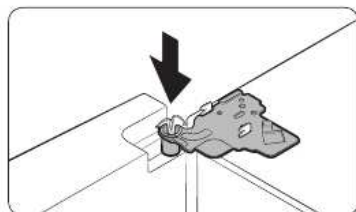

2. Put the top hinge into position on the top of the refrigerator, and then insert the hinge shaft into the top hole of the door. Make sure the wires from the door pass through the hole in the hinge shaft.

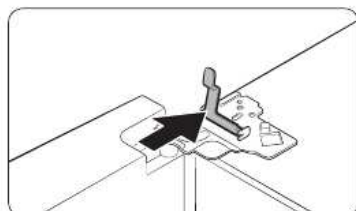

3. Insert the clamp in the direction of the arrow.

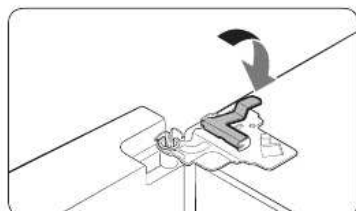

4. Push back the clamp as shown.

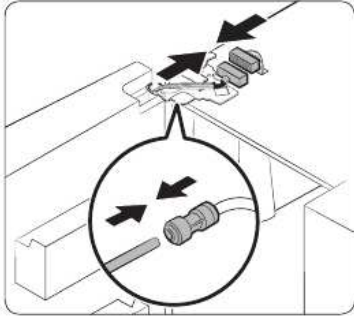

5. Connect the wire connectors.

⚠ CAUTION

- Make sure the wire connectors are connected properly. Otherwise, the display will not operate.

6. Connect the water tube.

⚠ CAUTION

- To prevent water leaks, make sure the red clips tighten the coupler properly.
- Keep the clips out of children's reach.

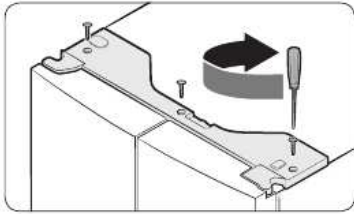

7. Repeat the above steps for the other door, except for Step 6. The right door does not have a water tube.

8. Attach the top cover with the front side first, and then press down on its back to get it into position. Then, tighten the screws (x3).

Installation

Installation

Step-by-step installation

STEP 1 Select a site

The site must:

- Have a solid level surface without carpeting or flooring that may obstruct ventilation
- Be out of direct sunlight
- Have adequate room for opening and closing the door
- Be away from any heat source
- Provide room for maintenance and servicing
- Have a temperature range between 50 °F (10 °C) and 110 °F (43 °C)

Clearance

See the pictures and table below and on the next page for installation space requirements.

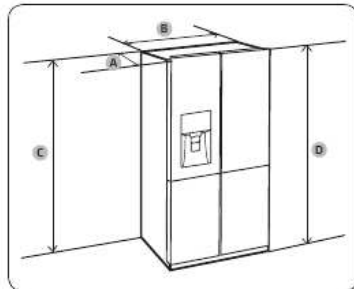

Depth "A"	34 1/4" (871 mm)
Width "B"	35 3/4" (908 mm)
Height "C"	70 3/4" (1797 mm)
Overall Height "D"	71 7/8" (1825 mm)

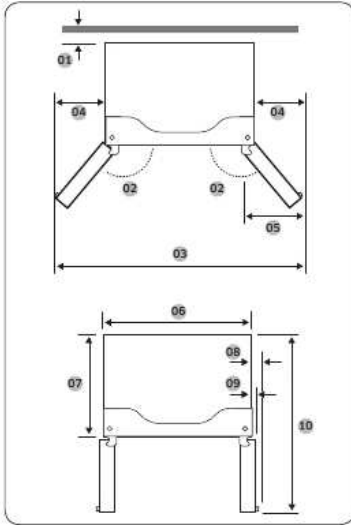

- 01 2" (50 mm)
- 02 125°
- 03 59 3/8" (1515 mm)
- 04 11 7/8" (303 mm)
- 05 12" (305 mm)
- 06 35 3/4" (908 mm)
- 07 29 3/8" (748 mm)
- 08 2 3/4" (70 mm)
- 09 1 3/4" (43 mm)
- 10 49" (1245 mm)

NOTE

The measurements of your refrigerator may differ from those listed above, depending on the measuring method.

Installation

Installation

STEP 2 Flooring

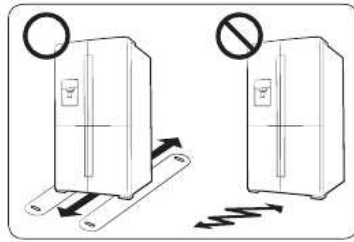

- The surface of the installation location must support a fully loaded refrigerator.
- To protect the floor, put a large piece of cardboard under each leg of the refrigerator when you move it for installation.
- To protect the floor once the refrigerator is in its final position, do not move it unless necessary. If you have to move it, place thick paper or cloth such as an old carpet, along the movement path.

NOTE

If the refrigerator cannot pass through entrance to your home or kitchen due to its size, see **Door removal for entrance** on page 18.

STEP 3 Adjust the levelling feet

⚠ CAUTION

- When installed, the refrigerator must be level on a flat, solid floor. Not leveling the refrigerator can cause damage to the refrigerator or physical injury.
- Levelling must be performed with the refrigerator empty. Make sure no food items are inside the refrigerator.
- For safety reasons, adjust the front side a little higher than the rear side.

You can level the refrigerator using the front legs. The front legs have a special screw (leveller) for levelling purposes. Use a flat-head screwdriver for levelling.

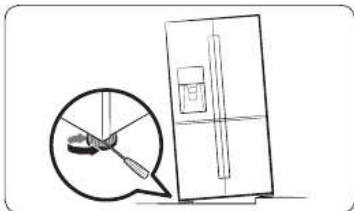

- To adjust the height of the freezer side: Insert a flat-head screwdriver into the leveller of the freezer-side front leg. Turn the leveller clockwise to raise the refrigerator. Turn it counterclockwise to lower.
- To adjust the height of the fridge side: Insert a flat-head screwdriver into the leveller of the fridge-side front leg. Turn the leveller clockwise to raise the refrigerator. Turn it counterclockwise to lower.

Installation

STEP 4 Adjust the door height as well as the door gap

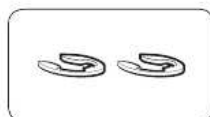

Snap ring

The height of a door can be adjusted using the provided snap rings, which come in 4 different sizes (1 mm, 1.5 mm, 2 mm, and 2.5 mm).

To adjust the height of a door



1. Check the height difference between the doors, and then raise and hold the lower door.

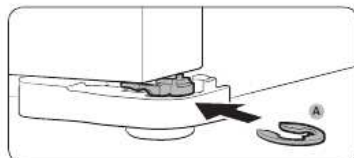

2. Insert a suitable-sized **snap ring (A)** between the door and the hinge as shown.

⚠ CAUTION

- Insert only one snap ring for this purpose. If you insert two or more snap rings, the rings may slip out or make a rubbing noise.
- Keep the snap rings out of children's reach, and keep them for future use.
- Do not raise the door too much. The door can contact and damage the top cover.

To correct the door gap (applicable models only)

RF28K907*

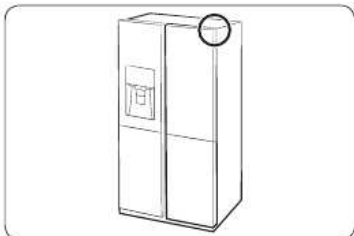

Door gaps can be corrected using the gap bolt on the top right corner of the refrigerator.

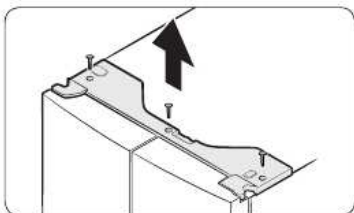

1. With the door closed, use a **Phillips screwdriver** to remove 6 screws on the top cover with the wire connectors.

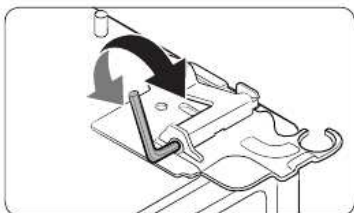

2. Use a 4 mm **Allen wrench** (not provided) to correct the door gap between two doors.
- To widen the gap, turn the gap bolt clockwise.
 - To narrow the gap, turn the gap bolt counterclockwise.
3. When done, reinsert the top cover.

⚠ CAUTION

The electrical connectors must be left intact during this process. Use caution so you don't tangle the connector wires or peel off the coating.

Installation

STEP 5 Connect the water dispenser line

A water dispenser with a filter is one of the helpful features on your new refrigerator. To help promote better health, the water filter removes unwanted particles from your water. However, it does not sterilize or destroy microorganisms. You may need to purchase a water purifying system to do that.

The water line also connects to the ice maker. For the ice maker to operate properly, a water pressure of 20-125 psi is required.

If the refrigerator is installed in an area with low water pressure (below 20 psi), you can install a booster pump to compensate for the low pressure.

After you have connected the water line, make sure the water storage tank inside the refrigerator is properly filled. To do this, press the water dispenser lever until the water runs from the water outlet.

NOTE

- Water line installation kits are available at extra cost from your retailer. We recommend using a water line installation kit that contains copper tubing and a 6 mm (1/4") compression nut.
- Use the new hose-sets supplied with the appliance only. Do not re-use an old hose set.

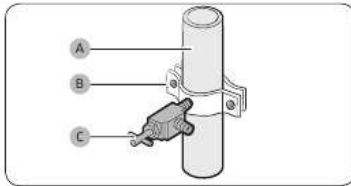

1. Shut off the main water source.
2. Insert the **pipe clamp (B)** and the **shut off valve (C)** into the cold water line (A).

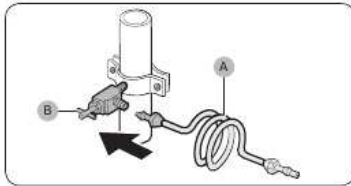

3. Connect the **water line installation kit (A)** to the **shut off valve (B)**.

Connect the water supply line to the refrigerator

There are several items you must purchase to complete this connection. You may find these items sold as a kit at your local hardware store.

Copper Tubing	<ul style="list-style-type: none">• 3/4" copper tubing• 3/4" compression nut (1 pc)• Ferrule (2 pc)
Plastic Tubing	<ul style="list-style-type: none">• 3/4" plastic tubing → Molded end (Bulb)• 3/4" compression nut (1pc)

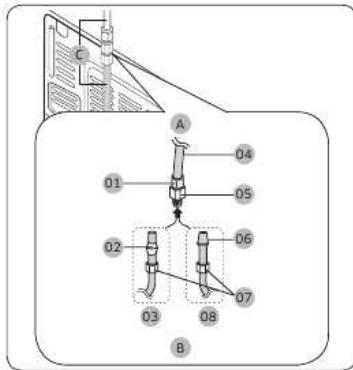

- A. Refrigerator
- B. Household water supply line
- C. Water Line: must be kept straight.

- 01 Compression Nut (3/4") (Assembled)
- 02 Ferrule (Not supplied)
- 03 Copper tubing (Not supplied)
- 04 Plastic Tubing (Assembled)
- 05 Compression Fitting (Assembled)
- 06 Molded end (Bulb)
- 07 Compression nut (B) (3/4") (Not supplied)
- 08 Plastic Tubing (A) (Not supplied)

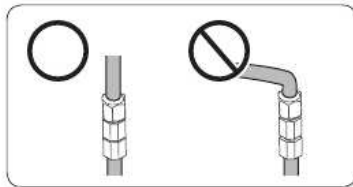

NOTE

If you have to relocate the refrigerator after connecting the **water line (C)**, make sure the joined section of the water line must be straight.

1. Connect the household water line to the assembled compression fitting.

- If you are using copper tubing, slip the **compression nut (B)** (not-supplied) and **ferrule** (not supplied) on the copper tubing (not supplied) as shown.
- If you are using plastic tubing (A), insert the molded end (Bulb) of the plastic tubing (A) into the compression fitting.

Installation

CAUTION

If you use plastic tubing, (A) do not use it without the molded end (Bulb).

2. Tighten the **compression nut** (B) onto the **compression fitting**. Do not over-tighten the **compression nut** (B).
3. Turn the water on and check for any leakage. If you find water drops or leakage in the connection areas, turn off the main water supply. Check the connections and, if necessary, tighten.
4. Flush 1 gallon of water through the filter before drinking or using the water from the refrigerator. (Flush approximately 6 minutes.) To flush, press a large glass or cup against the water dispenser lever. Fill the glass, empty it, and then repeat.
5. After you turn on the refrigerator, let the ice maker make ice for 1 to 2 days. Over that period of time, throw out the first 1 or 2 buckets of ice the ice maker makes to ensure all impurities have been removed from the water line.

NOTE

Only connect the water line to a potable water source.

- If you have to repair or disassemble the water line, cut off $\frac{1}{4}$ " of the plastic tubing to make sure you get a snug, leak-free connection.
- You can test the water line quickly using a paper cup. Under normal conditions, the water dispenser can fill a 5 $\frac{3}{4}$ oz. (170 cc) cup in about 10 seconds.

STEP 6 Initial settings

After you complete the following steps, the refrigerator should be fully functional.

1. Plug the power cord into the wall socket to turn the refrigerator on.
2. Open the door, and check if the interior light lights up.
3. Set the temperature to the coldest setting, and then wait for about an hour. Then, the freezer will be slightly chilled, and the motor should be running smoothly.
4. Wait until the refrigerator reaches the set temperature. Now the refrigerator is ready to use.

STEP 7 Final check

When installation is complete, confirm that:

- The refrigerator is plugged into an electrical outlet and grounded properly.
- The refrigerator is installed on a flat, level surface with appropriate clearance between it and any walls or cabinets.
- The refrigerator is level and is sitting firmly on the floor.
- The door opens and closes freely, and the interior light turns on automatically when you open the door.

Operations

Feature panel

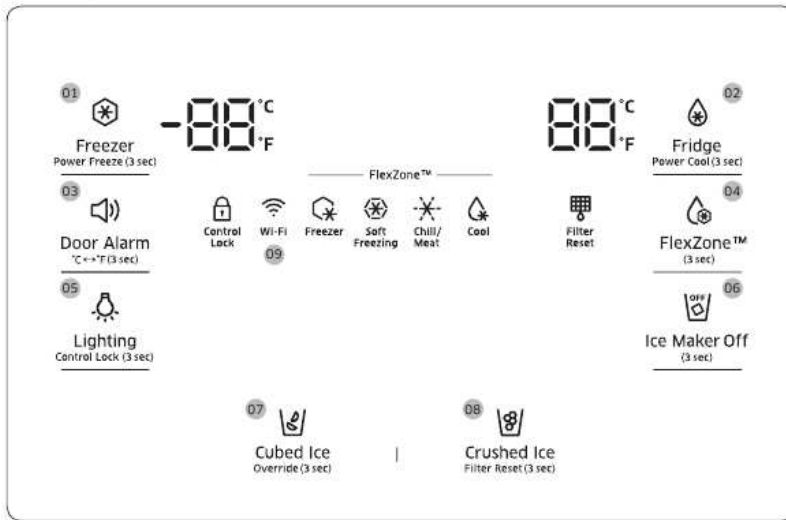

- | | | |
|----------------------------------|--------------------------------------|------------------------------|
| 01 Freezer / Power Freeze | 02 Fridge / Power Cool | 03 Door Alarm |
| 04 FlexZone | 05 Lighting / Control Lock | 06 Ice Maker Off |
| 07 Cubed Ice / Override | 08 Crushed Ice / Filter Reset | 09 Network connection |

NOTE

When you change the temperature on the panel, the panel displays the actual temperature inside the refrigerator until the temperature matches the temperature you set. Then, the panel displays the new set temperature. Note that it will take time for the refrigerator to reach the new temperature. This is normal. During this time, you need not set the temperature again.

Operations

Operations

01 Freezer / Power Freeze (3 sec)

Freezer	You can use the Freezer button to set the freezer temperature or to activate/deactivate Power Freeze. To set the freezer temperature, press Freezer repeatedly. Available temperatures are between 5 °F (-15 °C) and -8 °F (-23 °C).
Power Freeze	<p>Power Freeze lowers the freezer temperature and speeds up the freezing process. In Power Freeze mode, the freezer runs at full power for several hours and then returns to normal operation and the previous temperature setting.</p> <ul style="list-style-type: none"> To activate Power Freeze, press and hold Freezer for 3 seconds. The corresponding indicator (⊕) lights up, and the refrigerator speeds up the freezing process for you. To deactivate, press and hold Freezer for 3 seconds again. Power Freeze shuts off and the freezer returns to the previous temperature setting. To freeze large amounts of food, activate Power Freeze at least 20 hours before putting food in the freezer. <p>NOTE Using Power Freeze increases power consumption. If you do not need the Power Freeze function on, make sure you turn it off so that the refrigerator can return to normal operation and the previous temperature setting.</p>

02 Fridge / Power Cool (3 sec)

Fridge	<p>You can use the Fridge button to set the fridge temperature or to activate/deactivate Power Cool.</p> <p>To set the fridge temperature, press Fridge repeatedly to select a desired temperature between 34 °F (1 °C) and 44 °F (7 °C). The temperature indicator displays the currently set or selected temperature.</p>
--------	---



Power Cool	<p>The Power Cool function lowers the fridge temperature and speeds up the cooling process. In the Power Cool mode, the fridge runs at full power for several hours and then returns to normal operation and the previous temperature setting. Use Power Cool to rapidly cool food that spoils quickly or to rapidly cool the refrigerator after the door has been left open for some time.</p> <p>To start Power Cool, press and hold Fridge for 3 seconds. The Power Cool icon lights and the refrigerator speeds up the cooling process.</p> <p>To deactivate, press and hold Fridge for 3 seconds again. Power Cool turns off and the refrigerator returns to the previous temperature setting.</p> <p>NOTE</p> <p>Using Power Cool increases power consumption. If you do not need the Power Cool function on, make sure you turn it off so that the refrigerator can return to normal operation and the previous set temperature.</p>
------------	--



03 Door Alarm / °C ↔°F (3 sec)

Door Alarm	<p>You can enable or disable the door alarm by pressing Door Alarm. When Door Alarm is enabled and a door is left open for more than 2 minutes, the alarm will sound and the alarm indicator will blink. The Door Alarm function is enabled by factory default.</p>
°C ↔°F	<p>You can use the Door Alarm button to switch the temperature scale between Celsius and Fahrenheit.</p> <p>To switch the temperature scale, press and hold Door Alarm for 3 seconds.</p>



Operations

04 FlexZone

With the FlexZone function, you can select an appropriate temperature for the food you have stored in the FlexZone compartment. The FlexZone compartment is located on the bottom right of the refrigerator. To initiate the FlexZone function, press and hold **FlexZone** for 3 seconds, and then press **FlexZone** repeatedly to cycle through the modes. When a desired mode is selected, release the button. The FlexZone function has the following four modes:

Freezer	Select Freezer to set the FlexZone compartment to the same temperature as the freezer. Use to keep frozen food fresh.
Soft Freezing	Select Soft Freezing to set the FlexZone compartment to 23 °F (-5 °C). Use to keep meat and fish fresh for an extended time.
Chill / Meat	Select Chill / Meat to set the FlexZone compartment to 30 °F (-1 °C). Use when storing deli food such as steak, cold cuts, fish, bacon, and cheese.
Cool	Select Cool to set the FlexZone compartment to 41°F (5 °C). Use when storing beverages that you will use fairly quickly or beverages you want to keep cold such as water, juice, soft drinks, and beer.

CAUTION

- When you switch or turn off this function, blood in meat or moisture in food may come out due to the temperature change.
- Do not store meat or food in the FlexZone compartment at the Cool setting. The meat or food may spoil.

NOTE

If the **FlexZone** button does not activate the function, make sure the button is unlocked. Press and hold **Lighting/Control Lock** for more than 3 seconds until the lock icon turns off. Then, press and hold **FlexZone** for more than 3 seconds to change the mode.



05 Lighting / Control Lock (3 sec)

Lighting	By default, the dispenser lamp turns on only when the dispenser is used. If you want to keep the dispenser lamp turned on (continuous mode), press Lighting . The lighting indicator also turns on. To restore the default settings, press Lighting again.
Control Lock	To prevent accidental setting changes, press and hold Control Lock for 3 seconds. All controls will be disabled and the Lock indicator (🔒) will turn on. When Control Lock is on, the refrigerator does not dispense ice or water, even if the Dispenser Lever is pressed. To deactivate, press and hold again for 3 seconds. The Lock indicator turns off and the controls are re-enabled.
Device authentication	When connecting the refrigerator to Samsung Smart Home App or Samsung smart devices such as Samsung Smart TVs, follow the app's or device's onscreen instructions and press and hold Control Lock for 5 seconds. The temperature panel displays "on" for 5 seconds before proceeding with the authentication procedure. Note that the Control Lock function will be not affected by this authentication.

06 Ice Maker Off (3 sec)

Ice Maker Off	To disable ice making, press and hold Ice Maker Off for 3 seconds. In this mode, ice making is disabled even if you press Cubed Ice or Crushed Ice . To turn ice making back on, press and hold Ice Maker Off again for 3 seconds.
---------------	--

07 Cubed Ice / Override (3 sec)

Cubed Ice	You can select an ice type. Press Cubed Ice to dispense cubed ice. The corresponding indicator turns on.
Override	The Override function activates/deactivates Smart Grid (See page 46). Press Cubed Ice/Override for 3 seconds to set/clear the Override function.



Operations

08 Crushed Ice / Filter Reset (3 sec)

Crushed Ice	You can select an ice type. Press Crushed Ice to dispense Crushed Ice. The corresponding indicator turns on.
Filter Reset	After about 6 months of using the original water filter (which typically amounts to about 320 gallons (1200 liters) of water), the Filter indicator blinks red to remind you that the filter needs to be replaced. When this happens, replace the filter, and then press and hold Crushed Ice for 3 seconds. This resets the filter lifecycle detector and turns off the Filter indicator. NOTE <ul style="list-style-type: none">Some areas have relatively large amounts of lime in their water. This may reduce the lifecycle of the filter. In these areas, you will have to replace the water filter more often than specified above.If water is not dispensing properly, the water filter is most likely clogged. Even if the Filter indicator is not blinking, replace the water filter.
Cooling Off	Cooling Off mode (also called Shop mode), is designed for use by retailers when they are displaying refrigerators on the shop floor. In Cooling Off mode, the refrigerator's fan motor and lights operate normally, but the compressors do not run so that neither the refrigerator or the freezer run the cooling process. To enter Cooling Off mode, press and hold Fridge, Freezer, and Door Alarm for 5 seconds. The refrigerator chime sounds with the message of "OFF" on the temperature panel. To exit, press and hold again for 5 seconds.

09 Network connection

You can control and monitor your refrigerator through the Samsung Smart Home app. For more information, see the Samsung Smart Home section.

NOTE

- Recommended encryption systems include WPA/TKIP and WPA2/AES. Any newer or unstandardized Wi-Fi authentication protocols are not supported.
- Wireless networks may be affected by the surrounding wireless communication environment.
- If your Internet service provider has registered the MAC address of your PC or modem for identification, your Samsung Smart Refrigerator may fail to connect to the Internet. If this happens, contact your Internet service provider for technical assistance.

-
- The firewall settings of your network system may prevent your Samsung Smart Refrigerator from accessing the Internet. Contact your Internet service provider for technical assistance. If this symptom continues, contact a local Samsung service center or retailer.
 - To configure the wireless access point (AP) settings, see the user manual of the AP.
 - Samsung Smart Refrigerators support both Wi-Fi 2.4 GHz with IEEE 802.11 b/g/n and Soft-AP protocols (IEEE 802.11 n is recommended).
 - Unauthorized Wi-Fi wireless routers may fail to connect to applicable Samsung Smart Refrigerators.

Operations

Samsung Smart Home

Installation

Visit the Google Play Store, Galaxy Apps, or Apple App Store and search for "Samsung Smart Home". Download and install the Samsung Smart Home app provided by Samsung Electronics to your smart device.

NOTE

- The Samsung Smart Home app is designed for Android 4.0 (ICS) or higher, or iOS 7.0 or higher, and is optimized for Samsung smartphones (Galaxy S and Galaxy Note series).
- For improved performance, the Samsung Smart Home app is subject to change without notice, or discontinued support according to the manufacturer's policy.

Samsung account

You are required to register your Samsung account to use the app. If you don't have a Samsung account, follow the app's onscreen instructions to create a free Samsung account.

Getting started

1. Run the Samsung Smart Home app and log in with your Samsung account. iPhone users are required to provide the login information each time they access the app.
2. Select **Device** > the + icon, and then tap **Refrigerator**.
3. Follow the onscreen instructions to provide the necessary information about the router, and then tap **Next**.
4. Press and hold **Fridge** for more than 5 seconds until the "AP" message appears on the freezer display. Your refrigerator will be registered with the app.
5. When device registration is complete, the refrigerator icon will appear on the Samsung Smart Home app.
6. Tap the refrigerator icon to open the refrigerator page.
7. When a network connection is established, the Wi-Fi icon lights up on your refrigerator.

Refrigerator app

Integrated control

You can monitor and control your refrigerator at home and on the go.

- Tap the refrigerator icon in the Samsung Smart Home to open the refrigerator page.
- Check the operation status or notifications related to your refrigerator, and change options or settings if necessary.

NOTE

Some options or settings of the refrigerator may not be available for remote control.

Key features

Register Samsung Smart Home appliances to the Samsung Smart Home server for remote access.

Menu overview

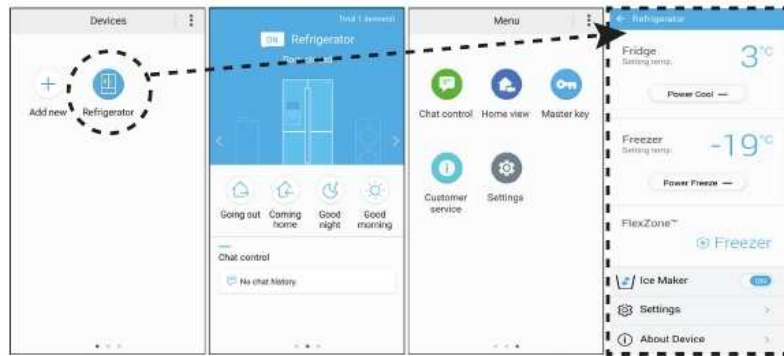

- Tap **Refrigerator** to open the settings page of the refrigerator.
- Swipe to move to the next page.

Chat control	You can control your Samsung Smart Home appliances remotely, or check the operating status.
Home view (applicable models only)	By using the built-in camera of a Samsung Smart Home appliance, you can monitor your living room. This is available only with applicable models.
Master key	The master key is designed to control the locking system for different user activities such as going out, coming home, going to bed at night, and waking up in the morning. This is available only with applicable models.
Customer service	The user manual is downloadable, and the contact information for customer support is also provided.
Settings	You can check the connected device as well as the software information (version and open-source licenses), and add devices or select a country. You can simulate the operation of the current device for demonstration purposes.

Operations

Refrigerator settings



A: Disabled (black)
B: Enabled (blue)

Fridge	<p>01 Displays the currently set fridge temperature.</p> <p>02 You can turn on or off Power Cool, and check the current settings.</p>
Freezer	<p>03 Displays the currently set freezer temperature.</p> <p>04 You can turn on or off Power Freeze, and check the current settings.</p>
FlexZone™	05 Displays the current mode setting.
Ice Maker	06 You can turn on or off Ice Maker, and check the current settings as well as the ice making status.

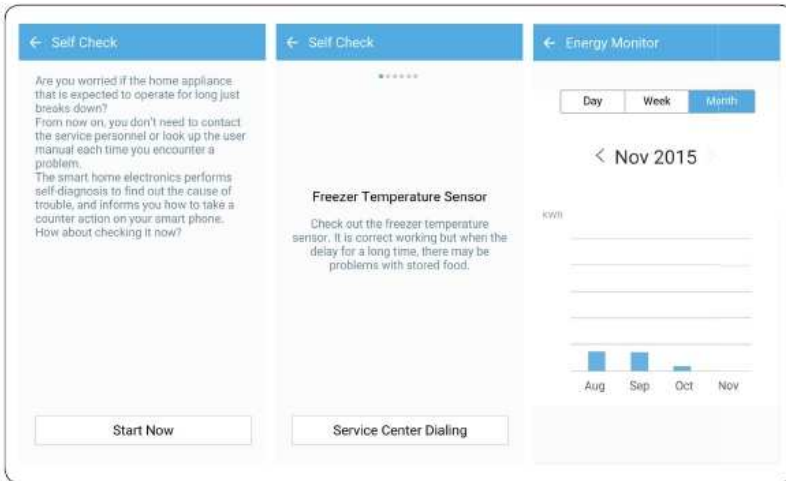

Settings	<p>07 On the Settings screen, you can monitor the energy usage status of your refrigerator in a preferred format. Supported formats are daily, weekly, or monthly cumulative energy consumption reports covering a max of the last 180 days.</p>
About Device	<p>08 Displays the product information including the current version, tutorial, Self Check, and Help Desk. The user manual is downloadable, and the contact information for customer support is also provided.</p> <p>Self Check By referencing Self Check, you can check the diagnostic results of your refrigerator. If the refrigerator detects an issue to check, it displays detailed information about the issue that can be used for customer service.</p>

Operations

Operations

SMART GRID Function (Demand Response)

When the refrigerator operates in SMART GRID (Demand Response) mode, the Energy Management Refrigerator function can control energy usage or delay the operation of some functions to save money when energy prices or demand are the highest.

NOTE

- You can deactivate the SMART GRID (Demand Response) function at any time using the Override On/Off function.)
- To use the SMART GRID (Demand Response) function, you need a separate contract with your electric utility company.

In addition, to use the Smart Grid (Demand Response) function, you must register for the service with your electric company. The company must have an EMS (Energy Management System) that supports SEP (Smart Energy profile).

Using the SMART GRID (Demand Response) Function

This feature monitors energy prices and demand information from your utility company and sends notifications to the refrigerator to run high energy consuming tasks during off-peak times when electricity costs and demand are lower.

If the refrigerator receives a control signal from the utility company, the refrigerator will display the **DAL** (L3) ~ **TALR** (L4) levels on the refrigerator display and control the power consumption according to the level.

[Exception condition] The **DAL** and **TALR** control signals from a utility company work as long as product performance is maintained.

If the refrigerator receives the SMART GRID (Demand Response) signal (**DAL** or **TALR**), the refrigerator will operate in Delay Appliance Load (Display:L3) or Temporary Appliance Load Reduction (Display:L4) mode.

- Delay Appliance Load (L3): The refrigerator responds to a **DAL** signal by providing a moderate load reduction for the duration of the delay period. This function controls functions that consume a lot of energy such as adjusting the Cooling system, running the defrost cycle, and making ice.
 - When the refrigerator operates in **DAL** (L3) mode, "L3" is displayed on the refrigerator display.
 - **DAL** mode is automatically deactivated after it lasts for the amount of time stipulated by the **DAL** signal (max. 4.5 hours) or when the Override key is pressed.



- Temporary Appliance Load Reduction (L4): The refrigerator responds to a **TALR** signal by aggressively reducing the load for a short time period. This function reduces energy consumption by stopping the compressor and controlling the functions that consume a lot of energy such as the defrost cycle and making ice.
 - When the refrigerator operates in **TALR (L4)** mode, "L4" is displayed on the refrigerator display.
 - **TALR (L4)** mode is automatically deactivated after it lasts for the received duration (max. 15 minutes), or when the Override key is pressed. The mode is immediately deactivated and the refrigerator returns to the normal state when the door is opened or closed, or the dispenser is used.

To check the MAC address

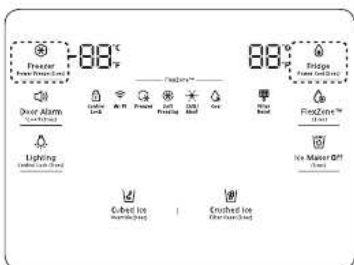

1. In this mode, the MAC address appears on the temperature panel (on both the freezer and the fridge sections of the panel) sequentially for 1 minute. Press and hold both **Freezer** and **Fridge** for 6 seconds. The temperature panel blinks. Then, press **Freezer** again to display the MAC address. The fridge beeps.
2. For example, if the MAC address is "11-22-33-44-55-66", the temperature panel displays the address for 1 minute in this sequence: "-- / --" → "11 / 22" → "33 / 44" → "55 / 66" → "-- / --". After the 1 minute, the MAC address disappears and the temperature panel returns to the normal state.

NOTE

The temperature panel displays "-- / --" for an unknown MAC address or if a Wi-Fi connection is not established or is lost.



Override Mode

When you want the refrigerator to ignore the SMART GRID (Demand Response) signal from the utility company, you can activate OVERRIDE mode.

When you activate OVERRIDE mode, the refrigerator ignores the SMART GRID (Demand Response) signal and is not controlled by the utility company.



Operations

Activating and deactivating Override mode

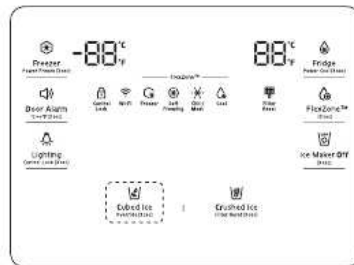

1. Press and hold **Cubed Ice** for 3 seconds.
2. A buzzer sounds and 'Or' and 'on' is displayed in the freezer and fridge temperature displays for 5 seconds.
3. If the refrigerator receives a SMART GRID (Demand Response) signal from the utility company, 'Or' is displayed in the freezer temperature display.
4. To deactivate **VERRIDE** mode, press and hold **Cubed Ice** for 3 seconds.
5. A Buzzer sounds and 'Or' and 'oF' is displayed on the fridge and freezer temperature displays for 5 seconds.

NOTE

- Alternatively, you can activate or deactivate **VERRIDE** mode using the Samsung Smart Home app and the Energy Management function. See the next page.



Using the Energy Management Function

The Energy Management function enables you to control and monitor your Energy Management refrigerator using the Smart Home app for your convenience.

NOTE

- To use the Energy Management refrigerator functions, you have to install the corresponding app first.
1. Operational Status
 - You can check the DR and Override status.
 2. Energy Consumption Reporting
 - Shows the accumulated power consumption. Power consumption data is updated every 10 minutes.

NOTE

The energy consumption report may differ from the power consumption specifications of the product depending on the operating environment and the stored food.

3. Delay Defrost Capability
 - The Delay Defrost Capability function saves energy by delaying the defrost operation to a time specified by the user. You can configure the time, and this function will save energy during the specified period in a 24 hour cycle. If the time is not set, the function works with the default time settings. The default time settings are below:
 - 6 am to 10 am: 1st. November ~ 30th. April
 - 3 pm to 7 pm: 1st. May ~ 31th. October

To change the time setting for the Delay Defrost Capability

You can change the time setting for the Delay Defrost Capability on the app.



Operations

Provision for Open Access to the Connected Product Requirements

1. SGIP Open Standards (Smart Energy Profile 2.0 - <http://www.csep.org/>)
 - Energy Consumption Reporting
 - Demand Response
2. Samsung OPEN API
 - Operational Status, User Settings & Messages
 - ICE Maker Status: GET /external/icestatus?icegetstatus=opt (relevant to the energy consumption of the product 1)
 - Door Open Alarm: GET /devices/0/Door?type=opt (relevant to the energy consumption of the product 2)
 - DR Status: GET /external/dric?drgetstatus=opt
 - Delay Defrost Capability
 - Set Schedule of the Defrost Delay: POST /devices/0/defrost/addSchedule
 - Get Schedule of the Defrost Delay : GET /devices/0/defrost/getSchedule
 - Delete Schedule of the Defrost Delay: POST /devices/0/defrost/delSchedule
 - Defrost Delay On/OFF: PUT /devices/0/defrost/delayevent

Special features

The refrigerator has many convenient features.

Water dispenser

With the water dispenser, you can dispense water without opening the fridge door.

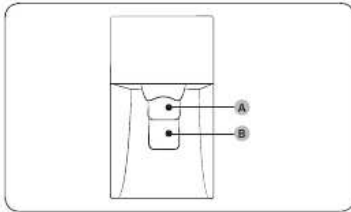

The water dispenser offers 3 options: chilled water, cubed ice, and crushed ice. If you do not want to dispense ice, simply press the **water lever (B)**.

With the Ice Maker enabled,

1. Press to select an ice type.
2. Put a water glass on the **ice lever (A)** and push it. Ice is dispensed from the dispenser.
3. Then, put the glass on the **water lever (B)** and push it. Water is dispensed from the dispenser.

NOTE

- To get ice and water, push the **ice lever (A)** first for ice, then move your glass down and press the **water lever (B)** for water.
- If you push both levers at once, only the first pushed lever operates.
- To prevent spills, wait 1 second before removing the glass after dispensing.
- Make sure the glass is in line with the dispenser to prevent the dispensed water from spilling out.
- If you do not use the water dispenser for 2-3 days, the dispensed water may have an abnormal smell or taste. This is not a system failure. Discard the first 1-2 glasses of water.

Operations

Ice maker

The refrigerator has a built-in ice maker that automatically dispenses ice so that you can enjoy filtered water with cubed or crushed ice to your preference.

Ice making

After you have installed your refrigerator and plugged it in, follow these instructions to ensure proper ice making and to keep the ice bucket full of ice:

1. Let the refrigerator operate for at least 24 hours to ensure optimal performance.
2. Dispense the first 4 to 6 ice cubes into a glass.
3. Wait another 8 hours and dispense another 4 to 6 ice cubes.
4. Then, wait another 16 hours and dispense the first glass-full of ice.

NOTE

- If you consume all the ice at once, you must wait 8 hours before dispensing the first 4 to 6 cubes. This ensures that the ice bucket is filled with ice properly.
- Ice cubes generated rapidly may look white, which is normal.

Diagnosis

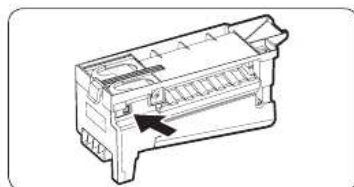

If ice does not dispense, first check the ice maker.

To check the ice maker

1. Press **Test** on the side of the ice maker. You will hear a chime (ding-dong) when you press the button.
2. You will hear another chime if the ice maker is operating properly.

CAUTION

- If the ice making chime rings repeatedly, contact the waterline installer or a local Samsung service center.
- Do not press **Test** repeatedly after the ice tray is filled with ice or water. Water may overflow or ice may jam.
- Do not put food in the ice bucket. The frozen food may damage the ice maker, especially when you open or close the door.
- When the refrigerator recovers power after a power failure, the ice bucket may contain a mix of melted and jammed ice cubes, which can prevent the ice maker from working properly. To prevent this, make sure to empty the ice bucket before using the refrigerator.
- Do not put fingers or any objects into the dispenser outlet or the ice maker. This can cause physical injury or property damage.

- When reinserting the ice maker tray, make sure that the tray is properly centered at the entrance. Otherwise, the tray can get stuck.

Ice Maker Off

If you press Ice Maker to turn the ice maker off, make sure to remove all ice cubes from the ice bucket. Remaining ice cubes may clump together, making it difficult to remove them.

To remove the ice bucket

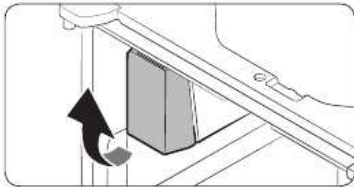

1. Hold the bottom of the ice bucket with one hand and hold the side with the other hand.
2. Gently lift it up and pull out.

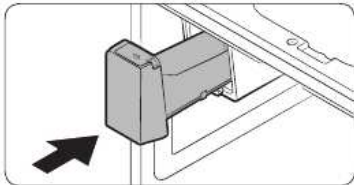

3. Remove the remaining ice cubes and put the ice bucket back into place.

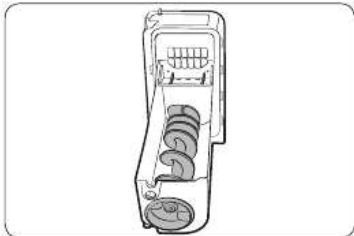

If the ice bucket is not firmly inserted, turn the ice screw 90 degrees, and then try again.

NOTE

- Removal of the ice bucket does not affect the thermal and mechanical performance of the refrigerator.

Operations

Water clouding

Water supplied to the refrigerator flows through a core alkaline filter. During this filtering process, the water pressure of the water increases and the water becomes saturated with oxygen and nitrogen. This causes the water to look misty or cloudy temporarily when dispensed. This is normal and the water will look clear after a few seconds.

Wine Rack

The refrigerator ships with the wine rack, which can be positioned in one of 3 positions: under the shelf, in the partition guide or on top of the sliding shelf of the FlexZone. Availability of the position depends on the model.

CAUTION

To remove or insert the wine rack, make sure that the wine rack is empty.

Under the shelf

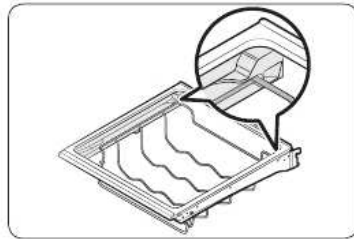

Insert the wine rack under the shelf of the fridge. Make sure to insert it to the end as marked in the figure.

In the partition guide

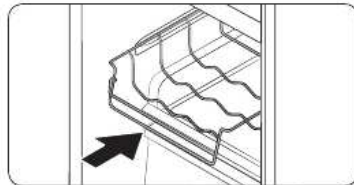

Insert the wine rack in the partition guide of the FlexZone.

- Make sure the front of the wine rack fits in the partition guide on the inner left-hand side of the FlexZone.

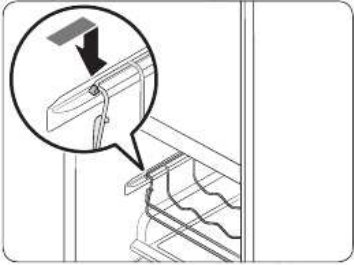

On the sliding shelf

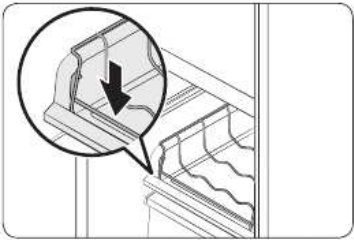

Insert the wine rack on top of the sliding shelf of the FlexZone, normally below the partition guide.

⚠ CAUTION

- Do not store wine bottles in the freezer. The bottles freeze and break, causing physical injury.
- Do not store wine bottles in two rows. The bottles may fall, causing physical injury.
- Do not store the wine bottles taller than 330 mm in height. The bottles may break when you close the door, causing physical injury.

Operations

Maintenance

Handle and care

Icemaker bucket

If you do not dispense ice for an extended period, ice may form clumps inside the bucket. If this happens, remove and empty the icemaker bucket.

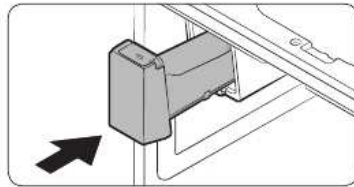
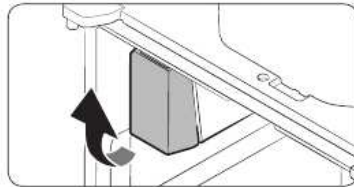

1. To remove the ice maker bucket, gently lift it up, and then pull it out slowly while holding the bottom of the bucket with one hand and the side with the other hand.
2. Lift up and pull the bucket out. Empty the bucket.
3. When done, put the bucket back into position. If the bucket does not fit in, turn the helix screw 90 degrees, and then try again.

⚠ CAUTION

- Do not apply excessive force to the bucket cover. The cover may break.
- Do not forcefully close the door. Water may spill over the ice maker.
- To prevent injury, make sure to clean up any ice or water that has fallen on the floor.
- To prevent accidents or injury, do not let children play with the water dispenser or the ice maker.
- Do not put your hand or an object into the ice chute. This may cause physical injury or product damage.
- Use only the provided ice bucket. Third-party ice buckets may cause a system failure.
- Use only potable water that is connected to the water supply line.

📖 NOTE

- The water pressure required for ice making is between 20 psi and 125 psi.
- If the Ice Off indicator blinks, remove and reinsert the ice bucket. Make sure it is reinserted properly.
- Noise from the ice maker as it produces ice during the ice making process is normal.
- While the door is open, neither the ice maker nor the water dispenser operates.

Tempered glass shelves (fridge)

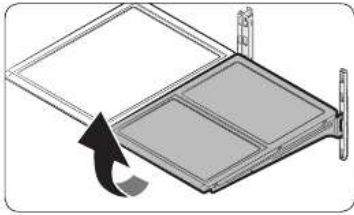

- To remove a shelf, fully open the corresponding door. Hold the front of the shelf, and then gently lift up and slide out.

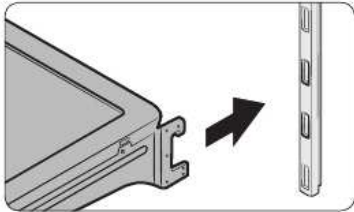

- To reinsert, hold the shelf at an angle so the front is higher than the back, and then insert the top hook into the top shelf notch. Then, lower the shelf and insert the bottom shelf hook into the bottom shelf notch.

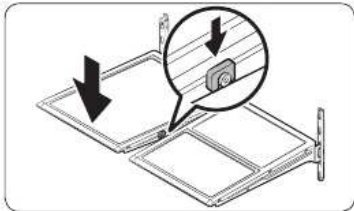

⚠ CAUTION

- The tempered glass shelves are heavy. Use caution when removing them.
- The shelf must be inserted correctly. Do not insert upside down.
- Glass containers may scratch the surface of glass shelves.

Maintenance

Door bins

The top door bin section has a marked line to ensure easy removal and proper reinsertion.

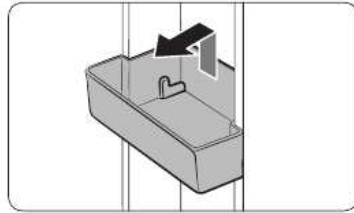

Lift up the door bin, and then pull out straight.

⚠ CAUTION

Do not allow children to play with the bins. Sharp-edged corners may cause injury.

Vegetable & fruit drawers (EZ fresh zone)

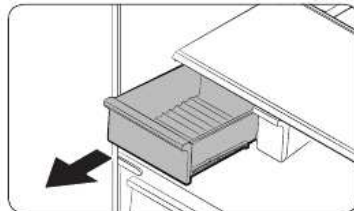

Gently lift up the front of the drawer and slide out.
We recommend that you remove the door bins before removing the drawer. This is to prevent damage to the door bins.

Vegetable shelf

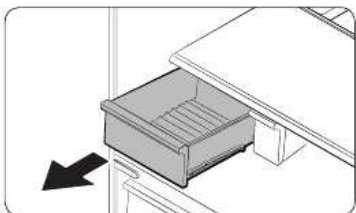

1. Slide out the left-side vegetable drawer.

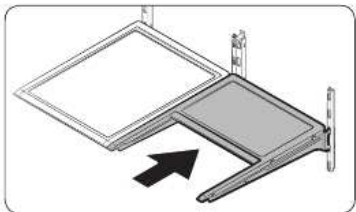

2. Slide in the right-side foldable shelf.

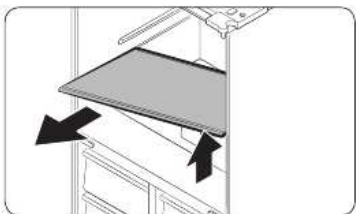

3. While supporting the vegetable shelf with one hand, slide it out with the other hand.

NOTE

To use the space that is opened up after removing the foldable shelf, take out the vegetable shelf.

To reinsert, follow the steps above in the reverse order.

Ice bucket

To remove the ice bucket, see the Maintenance section on page 53.

Maintenance

Cleaning

Interior and exterior

⚠ WARNING

- Do not use benzene, thinner, or home/car detergent such as Clorox™ for cleaning. They may damage the surface of the refrigerator and cause a fire.
- Do not spray water onto the refrigerator. This may cause electric shock.
- Do not put fingers or any objects into the dispenser outlet.

Regularly use a dry cloth to remove all foreign substances such as dust or water from the power plug terminals and contact points.

1. Unplug the power cord.
2. Use a moistened, soft, lint-free cloth or paper towel to clean the refrigerator's interior and exterior.
3. When done, use a dry cloth or paper towel to dry well.
4. Plug in the power cord.

Replacement

Water filter

⚠ WARNING

- Do not use third-party water filters. Use only Samsung-provided or -approved filters.
- Unapproved filters may leak and damage the refrigerator, causing electric shock. Samsung is not responsible for any damage that may occur from use of third-party water filters.

The filter indicator () turns red to let you know it is time to replace the water filter. Before replacing the filter, make sure the water supply line is shut off.

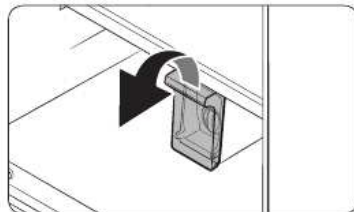

1. Open the filter cover.

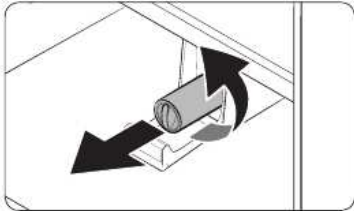

2. Turn the knob of the filter cartridge counter clockwise 90 degrees (1/4 turn). The filter cartridge unlocks.
3. Pull out to remove the cartridge.
 - If the water filter is severely contaminated, the cartridge may not be easy to remove. If that is the case, use force to remove the cartridge.
 - To prevent water leaks from the filter opening, keep the cartridge straight while removing it.

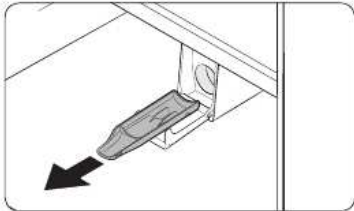

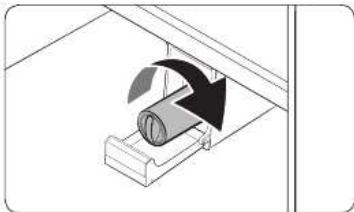

NOTE
To prevent overflow, empty and dry the water filter tray.

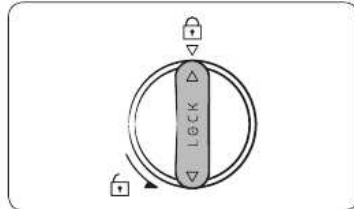

4. Insert a new filter cartridge. Use only Samsung-provided or approved filters.

Maintenance



5. Turn the cartridge knob clockwise to lock into place.
6. Press and hold **Crushed Ice** on the feature panel for 3 seconds to reset the life cycle detector.
The filter indicator () turns off.
7. When you are done replacing the filter, open the water valve and run water through the dispenser for about 7 minutes. This is to remove impurities and air from the water line.

NOTE

- A newly installed filter may cause the water dispenser to spurt water briefly. This is because air has entered the waterline.
- The replacement process may cause the water dispenser to drip for a short period of time. If it drips, simply wipe up any water on the floor with a dry towel.

Reverse osmosis water filtration system

The water pressure of the water supply system to a reverse osmosis water filtration system must be between 35 psi and 120 psi (241 kPa and 827 kPa).

The water pressure of the reverse osmosis water filtration system to the refrigerator's cold water line must be at least 40 psi (276 kPa). If the water pressure is below these specifications:

- Check if the sediment filter in the reverse osmosis system is blocked. Replace the filter if necessary.
- Refill the water tank in the reverse osmosis system with water.
- If your refrigerator has a water filter, it may further reduce the water pressure when used in conjunction with a reverse osmosis system. Remove the water filter.

For more information or servicing, contact a licensed plumbing professional.

Ordering a new filter

To purchase a new water filter, contact a local Samsung service center or visit www.samsungparts.com on the web.

LED Lights

To replace the LED lights on the refrigerator, contact a local Samsung service center.

WARNING

The LED lights are not user-serviceable. Do not attempt to replace an LED light yourself. This can cause electric shock.

Troubleshooting

If you encounter a problem with the refrigerator, first check the tables starting below, and then try the suggested actions.

General

Symptom	Action
The refrigerator does not operate or cool.	<ul style="list-style-type: none">• Make sure the power cord is connected properly.• Make sure the temperature control is set correctly. Try setting to a lower temperature.• Make sure the refrigerator is not being exposed to direct sunlight and is not near a heat source. Failing to do so may affect the cooling performance.• Make sure the refrigerator is far enough away from rear walls, side walls, or cabinets to allow proper ventilation. Failing to do so may affect the cooling performance.• Too much food can block the internal ventilation of the refrigerator. To keep the refrigerator operating normally, do not put too much food inside.
Food in the fridge freezes.	<ul style="list-style-type: none">• Check if the temperature control is set to the lowest temperature. If so, change to a higher temperature.• This can happen if the ambient room temperature is too low. Set the room temperature higher.• Check if food containing a high proportion of water has been put in the coldest area of the fridge or near the cooling vent. If so, move the food to other shelves in the fridge.
You hear unusual noises or sounds.	<ul style="list-style-type: none">• Make sure the refrigerator is installed on a stable, flat surface.• Make sure the refrigerator is far enough away from rear walls, side walls, and cabinets to allow proper ventilation.• Make sure that there are no foreign objects (coins, keys, cutlery, etc.) inside or underneath the refrigerator.• The refrigerator may produce a ticking sound from inside. This occurs when the various accessories contract or expand as the temperature inside changes. This is normal.

Symptom	Action
The front corners and sides become warm and form condensation.	<ul style="list-style-type: none"> To prevent condensation from forming, the refrigerator has heat-proof piping in the front corners. If the ambient temperature rises, this equipment may not work effectively. This is not a system failure. Make sure the door is closed properly. Condensation may form if you leave the door open for an extended period of time. Condensation may form on the exterior surface of the refrigerator if humid air comes into contact with the cool surface of the refrigerator.
The ice maker does not make ice.	<ul style="list-style-type: none"> If you have used all the ice in the ice bucket, you must wait for 12 hours for the refrigerator to make more ice. See if the Ice Maker Off icon is lit. If it is, press and hold Ice Maker Off for 3 seconds. Make sure the freezer is set below 32 °F (0 °C) (or 23 °F (-5 °C) in warm ambient air). Make sure the water line is properly connected and the shut-off valve is open. Check if the ice bucket contains ice clumps. If it does, empty the ice bucket and try again.
The water dispenser is not functioning.	<ul style="list-style-type: none"> Make sure the water line is properly connected and the shut-off valve is open. Make sure the water supply line tubing is not damaged such as crushed or kinked. Make sure the water filter is installed properly.
You hear a bubbling sound.	<ul style="list-style-type: none"> This is normal. The bubbling sound comes from refrigerant circulating through the refrigerator.
A bad smell comes from inside the refrigerator.	<ul style="list-style-type: none"> Check for any spoiled food. We recommend cleaning the refrigerator on a regular basis and removing any spoiled or suspect food items. Make sure strong smelling food is wrapped tightly or stored in air tight containers.
Frost forms on the interior walls.	<ul style="list-style-type: none"> Make sure the air vents are not blocked by food or any other objects so that the air can circulate freely. For efficient air circulation, it is recommended to arrange food items evenly. Make sure the door is closed properly.

Troubleshooting

Troubleshooting

Symptom	Action
Condensation or water drops form on or around the vertical mullion.	<ul style="list-style-type: none">While the refrigerator is operating, condensation or water drops may form on or around the vertical mullion if the surrounding humidity is too high.

Samsung Smart Home

Symptom	Action
Could not find "Samsung Smart Home" in the app market.	<ul style="list-style-type: none">The Samsung Smart Home app is available for smartphones that run Android 4.0 (ICS) or higher, or iOS 7.0 or higher.
The Samsung Smart Home app fails to operate.	<ul style="list-style-type: none">The Samsung Smart Home app is available on applicable models only.The old Samsung Smart Refrigerator app cannot connect with Samsung Smart Home models.
The Samsung Smart Home app is installed but is not connected to my refrigerator.	<ul style="list-style-type: none">You must log into your Samsung account to use the app.Make sure that your router is operating normally.If the Wi-Fi icon on the refrigerator's display is off, this indicates that no network connection has been established yet. In this case, use the Samsung Smart Home app to connect and register your refrigerator to the access point (AP) of your house.
Could not log into the app.	<ul style="list-style-type: none">You must log into your Samsung account to use the app.If you don't have a Samsung account, follow the app's onscreen instructions to create one.
An error message appears when I try to register my refrigerator.	<ul style="list-style-type: none">Easy Connection may fail due to the distance from your access point (AP) or electrical interference from the surrounding environment. Wait a moment and try again.
The Samsung Smart Home app is successfully connected to my refrigerator but does not run.	<ul style="list-style-type: none">Exit and restart the Samsung Smart Home app, or disconnect and reconnect the router.Unplug the power cord of the refrigerator, and plug it again after 1 minute.

Troubleshooting

Smart Grid

Symptom	Action
What Do I Need to use the Energy Management and Smart Grid functions?	<p>To use the Smart Grid (Demand Response) and Energy Management functions on your refrigerator, you need the following:</p> <p>Devices</p> <ul style="list-style-type: none"> • Wireless access point (router) • Samsung Energy Management-supported refrigerator • Smartphone <p>Registration</p> <ul style="list-style-type: none"> • Connect your refrigerator to your home Wi-Fi network. • Register for the EMS service with your electric company that has an EMS (Energy Management System) supporting SEP (Smart Energy profile). <p>Application</p> <ul style="list-style-type: none"> • Download the Samsung Smart Home app from the Google Play Store, Apple App Store, or Samsung Galaxy Apps. • Install and run the Samsung Smart Home app on your smartphone.
Why isn't the Energy Management function working normally?	<ul style="list-style-type: none"> • Make sure that your home router is operating normally with proper Internet service and connection. • Make sure that the refrigerator is connected to the AP. <p>Checkpoints</p> <ul style="list-style-type: none"> • Connect your smartphone to the router (AP, Access Point), and then check if you can browse the Internet on the smartphone. • Check if the Wi-Fi icon on the refrigerator's display is on. If not, connect the refrigerator to the AP.
Why isn't the Delay Defrost Capability working normally?	<ul style="list-style-type: none"> • Make sure that your home router is operating normally with proper Internet service and connection. • Make sure that the refrigerator does not display L3 or L4 on the display panel.

Warranty (USA)

WARRANTY ON SAMSUNG REFRIGERATOR

LIMITED WARRANTY TO ORIGINAL PURCHASER

This Samsung brand product, as supplied and distributed by Samsung Electronics America, Inc. (Samsung) and delivered new, in the original carton to the original consumer purchaser, is warranted by Samsung against manufacturing defects in materials and workmanship for a limited warranty period of:

One (1) year Parts and Labor on Refrigerator

Five (5) years Parts and Labor on sealed Refrigeration system only*

Ten (10) years Parts and Five (5) years Labor on Digital Inverter Compressor

(*Compressor, evaporator, condenser, drier, connecting tubing)

This limited warranty begins on the original date of purchase, and is valid only on products purchased and used in the United States. To receive warranty service, the purchaser must contact Samsung for problem determination and service procedures. Warranty service can only be performed by a Samsung authorized service center. The original dated bill of sale must be presented upon request as proof of purchase to Samsung or Samsung authorized service center.

Samsung will repair or replace any part found to be defective, at our option and at no charge as stipulated herein, with new or reconditioned parts during the limited warranty period specified above. All replaced parts and products become the property of Samsung and must be returned to Samsung. Replacement parts and products assume the remaining original warranty, or ninety (90) days, whichever is longer.

In-home service will be provided during the warranty labor period subject to availability within the contiguous United States. In-home service is not available in all areas. To receive in-home service, the product must be unobstructed and accessible from floor level to service personnel. If during in-home service repair cannot be completed, it may be necessary to remove, repair and return the product. If in-home service is unavailable, Samsung may elect, at our option, to provide for transportation of our choice to and from a Samsung authorized service center. Otherwise, transportation to and from the Samsung authorized service center is the responsibility of the purchaser.

Warranty (USA)

This limited warranty covers manufacturing defects in materials and workmanship encountered in normal, noncommercial use of this product, and shall not apply to the following, including, but not limited to: damage which occurs in shipment; delivery and installation; applications and uses for which this product was not intended; altered product or serial numbers; cosmetic damage or exterior finish; accidents, abuse, neglect, fire, water, lightning or other acts of nature; use of products, equipment, systems, utilities, services, parts, supplies, accessories, applications, installations, repairs, external plumbing and leaks, external wiring, circuit breakers, fuses or connectors not supplied and authorized by Samsung, or which damage this product or result in service problems; incorrect electrical line voltage, fluctuations and surges; customer adjustments and failure to follow operating instructions, cleaning, maintenance and environmental instructions that are covered and prescribed in the instruction book; loss of food due to spoilage; consumable items including filters and light.

THERE ARE NO EXPRESS WARRANTIES OTHER THAN THOSE LISTED AND DESCRIBED ABOVE, AND NO WARRANTIES WHETHER EXPRESS OR IMPLIED, INCLUDING, BUT NOT LIMITED TO, ANY IMPLIED WARRANTIES OF MERCHANTABILITY OR FITNESS FOR A PARTICULAR PURPOSE, SHALL APPLY AFTER THE EXPRESS WARRANTY PERIODS STATED ABOVE, AND NO OTHER EXPRESS WARRANTY OR GUARANTY GIVEN BY ANY PERSON, FIRM OR CORPORATION WITH RESPECT TO THIS PRODUCT SHALL BE BINDING ON SAMSUNG. SAMSUNG SHALL NOT BE LIABLE FOR LOSS OF REVENUE OR PROFITS, FAILURE TO REALIZE SAVINGS OR OTHER BENEFITS, OR ANY OTHER SPECIAL, INCIDENTAL OR CONSEQUENTIAL DAMAGES CAUSED BY THE USE, MISUSE OR INABILITY TO USE THIS PRODUCT, REGARDLESS OF THE LEGAL THEORY ON WHICH THE CLAIM IS BASED, AND EVEN IF SAMSUNG HAS BEEN ADVISED OF THE POSSIBILITY OF SUCH DAMAGES. NOR SHALL RECOVERY OF ANY KIND AGAINST SAMSUNG BE GREATER IN AMOUNT THAN THE PURCHASE PRICE OF THE PRODUCT SOLD BY SAMSUNG AND CAUSING THE ALLEGED DAMAGE. WITHOUT LIMITING THE FOREGOING, PURCHASER ASSUMES ALL RISK AND LIABILITY FOR LOSS, DAMAGE OR INJURY TO PURCHASER AND PURCHASER'S PROPERTY AND TO OTHERS AND THEIR PROPERTY ARISING OUT OF THE USE, MISUSE OR INABILITY TO USE THIS PRODUCT SOLD BY SAMSUNG NOT CAUSED DIRECTLY BY THE NEGLIGENCE OF SAMSUNG. THIS LIMITED WARRANTY SHALL NOT EXTEND TO ANYONE OTHER THAN THE ORIGINAL PURCHASER OF THIS PRODUCT, IS NONTRANSFERABLE AND STATES YOUR EXCLUSIVE REMEDY.

Some states do not allow limitations on how long an implied warranty lasts, or the exclusion or limitation of incidental or consequential damages, so the above limitations or exclusions may not apply to you. This warranty gives you specific legal rights, and you may also have other rights, which vary from state to state. To obtain warranty service, please contact Samsung at:



SAMSUNG CUSTOMER CARE CENTER

Samsung Electronics America, Inc.
85 Challenger Road
Ridgefield Park, NJ 07660
1-800-SAMSUNG (726-7864)
www.samsung.com/us/support



Warranty Information (CANADA)

If your refrigerator needs service

Do not hesitate to call any Samsung Authorized Service Center nearby giving them your name, address and telephone number if your product is not functioning properly.

Limited Warranty for Original Purchaser

This Samsung product is warranted by Samsung Electronics Canada Inc. (hereafter referred to as SECA) against manufacturing defects in material or workmanship for the following periods:

Labor : 1 year (in-home)

Parts : 1 year

Inverter Compressor : 10 years (Part only)

SECA further warrants that if this product fails to operate properly within the specified warranty period and the failure is due to improper workmanship or defective material, SECA will repair or replace the product at its option. In-home service is not available in all areas. Contact us to find out if in-home service is currently available in your area by using the contact information at the back of this warranty.

All warranty repairs or part replacements must be performed by a SECA Authorized Service Center. (To find the nearest SECA Service Center, call 1-800-SAMSUNG (7267864) or visit our web site at www.samsung.com/ca)

Obligation to the Original Owner

The original dated sales receipt must be retained by the customer and is the only acceptable proof of purchase. It must be presented to a SECA Authorized Service Center at the time service is requested before warranty services are rendered. On all carry-in models, transportation to and from the Authorized Service Center is the responsibility of the customer.

Exclusions of the Warranty

This warranty does not cover damage due to accident, fire, flood, and/or other Acts of God, misuse, incorrect line voltage, improper installation, improper or unauthorized repairs, commercial use, or damage that occurs during shipping. Customer adjustments which are explained in this owners manual are not covered under the terms of this warranty. This warranty will automatically be voided for any unit found with a missing or altered serial number. This warranty is valid only on products purchased and used in the Canada.

SAMSUNG CUSTOMER CARE CENTER

Samsung Electronics Canada Inc.
2050 Derry Road West
Mississauga, Ontario L5N 0B9
Canada
1-800-SAMSUNG (726-7864)
www.samsung.com/ca/support (English)
www.samsung.com/ca_fr/support (French)

Open Source Announcement

The software included in this product contains open source software. You may obtain the complete corresponding source code for a period of three years after the last shipment of this product by sending an email to <mailto:oss.request@samsung.com>.

It is also possible to obtain the complete corresponding source code in a physical medium such as a CD-ROM; a minimal charge will be required.

The following URL <http://opensource.samsung.com/opensource/SimpleConnectTP/seq/0> leads to the download page of the source code made available and open source license information as related to this product. This offer is valid to anyone in receipt of this information.

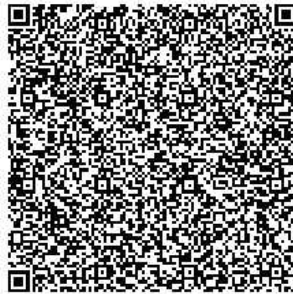

Memo

SAMSUNG



Scan the QR code* or visit
www.samsung.com/spn
to view our helpful
How-to Videos and Live Shows

* Requires reader to be installed on your
smartphone
Scan this with your smartphone

Contact SAMSUNG WORLD WIDE

If you have any questions or comments relating to Samsung products, please contact the SAMSUNG customer care center.

Country	Contact Center	Web Site
U.S.A	1-800-SAMSUNG (726-7864) 1-844-SAM-PAYS (726-7297)	www.samsung.com/us/support
CANADA	1-800-SAMSUNG (726-7864) 1-844-SAM-PAYS (726-7297)	www.samsung.com/ca/support (English) www.samsung.com/ca_fr/support (French)



DA68-03378A-05