

CARRO

CARRO

INSTALLATION INSTRUCTIONS

CARROHOME.COM

MANUFACTURING QUALITY
CEILING FANS SINCE FOREVER.

Important: Please read and save these instructions before installation

Basic Product Specifications

Model	CES525JL-FM	Voltage	120V
Fan Blade Span	52"	Rated Wattage	48W(Fan 26W Lamp 22W)
Gross Weight	15.7lbs.	Motor RPM	50-205rpm
Maximum Airflow	5000CFM	Maximum Noise	58dB(A)

U.S. Patent Nos.: 10,511,206 and 11,296,561.
Other Patent(s) Pending.

Questions

Have questions about our products? Contact us and talk to our helpful tech support team.

Technical Support

Business Hours:
 Monday – Friday (Holidays observed).
9:00 am to 5:30 pm PST.
Tel: 888-253-2374

Live Smarter

This Carro Smart Ceiling Fan is :



ETL certified & damp-rated, suitable for indoor/covered -outdoor use

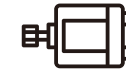

DC Motor 10-speed, ultraquiet, reversible & energy efficient



Connect via Wi-Fi or Bluetooth for advanced control



Compatible with smart devices



Connect to the **CARRO Home App** for fine-tuned control options

The Carro Home App conveniently connects to existing smart devices for full smart home integration.



works with **Alexa**



works with **Google Assistant**



works with **Siri Shortcuts**



Remote Control Included



Download via Google Play and App Store



- Before you begin installing the fan, shut power off at the circuit breaker of the fuse box.
- Make sure that all electrical connections are in accordance with National Electrical Code, ANSI/NFPA 70 and local codes. Hire a licensed electrician if you are unfamiliar with installing electrical wiring.
- Make sure the installation site you choose allows the fan blades to rotate without any obstructions. Allow a minimum clearance of 2.1m (7 feet) from the floor and 18 inches from the tip of the blades to the wall.
- The outlet box and support structure must be securely mounted and capable of reliably supporting a minimum of 35 pounds. Use only U.L. listed outlet boxes marked "Acceptable for Fan Support of 15.9 kg (35 lbs) or less".
- Before and after you install the fan, make sure that all mounting components are secured to prevent the fan from falling.
- Do not insert anything into the fan blades while the fan is operating.
- To change the direction of the rotation of the blades, the fan must be in operation mode.
- All set screws must be checked and retightened where necessary before installation.
- After making the wire connections, the wires should be spread apart with the grounded conductor and the equipment-grounding conductor on one side of the outlet box and the ungrounded conductor on the other side of the outlet box.
- The splices after being made should be turned upward and pushed carefully up into the outlet box. Conductor wiring identified as grounded is to be connected to a grounded conductor of power supply. Conductor wiring identified as ungrounded conductor is to be connected to an ungrounded conductor. Conductor wiring identified for equipment grounding is to be connected to an equipment-grounding conductor.
- This device complies with part 15 of the FCC Rules. Operation is subject to the following two conditions: (1) This device may not cause harmful interference, and (2) this device must accept any interference received, including interference that may cause undesired operation.
- This product is suitable for use in damp locations.

- **CAUTION:** Read all instructions and safety information before installing your new fan. Review accompanying assembly diagrams.
 - **WARNING:** To reduce the risk of fire, electric shock, or personal injury, mount to outlet box marked "Acceptable for Fan Support of 15.9 kg (35 lbs) or less" and use mounting screws provided with the outlet box.
 - **CAUTION:** To reduce the risk of injury, use only the screws provided with the outlet box in conjunction with the lock washers.
 - **WARNING:** To reduce the risk of personal injury, do not bend the blade bracket when installing the brackets, balancing the blades, or cleaning the fan. Do not insert foreign objects in between rotating fan blades.
 - **CAUTION:** To reduce the risk of electric shock, disconnect the electrical supply circuit to the fan before installing the light kit.
 - **WARNING:** To reduce the risk of fire or electric shock, this fan must be installed with a general use, non-dimmable, single gang, isolating wall control/switch.
 - **WARNING:** To reduce the risk of fire or electric shock, do not use this fan with any solid-state speed control device.
- NOTE:** The important safeguards and instructions appearing in this manual are not meant to cover all possible conditions and situations that may occur. It must be understood that common sense, caution and care are factors which cannot be built into this product. These factors must be supplied by the person (s) installing, caring for and operating the unit.
- **CAUTION:** The light source is designed for this specific application and can overheat if serviced by untrained personnel. If any servicing is required, the product should be returned to an authorized service facility for examination or repair.

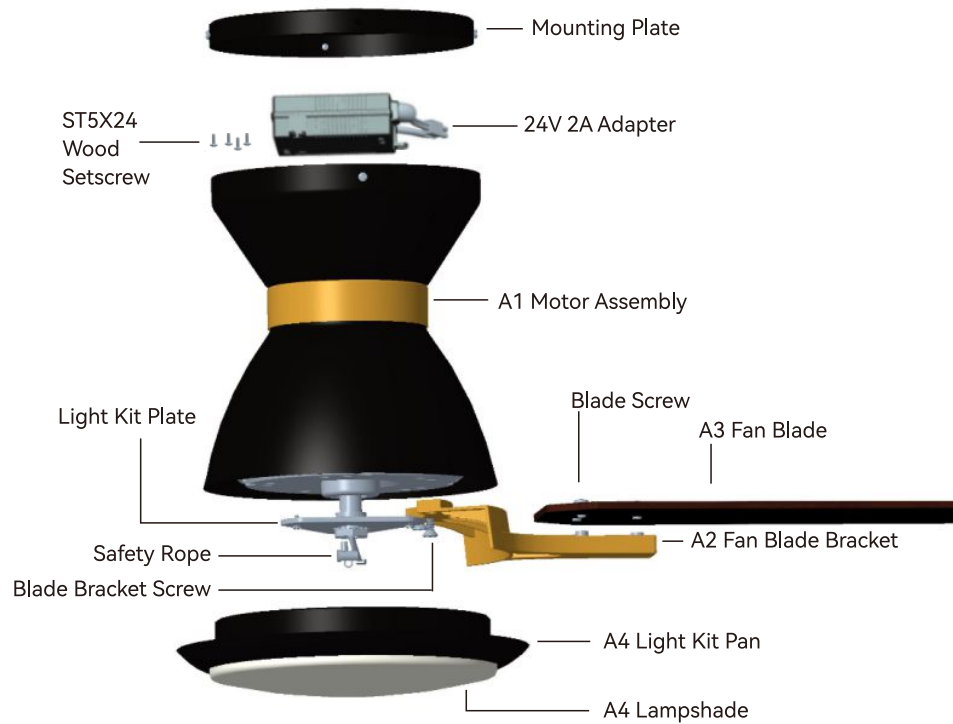

- 08 **Motor Assembly**
- 09 **Mounting Options**
- 10 **Hanging & Wiring**
- 11 **Securing The Fan**
- 12 **Fan Blade Brackets**
- 13 **Fan Blades/Light**
- 14 **Light Kit Pan & Light Kit**
- 15 **Lampshade / Power On**
- 16 **Remote Control**
- 17 **Carro Home App**
- 18 **Smart Devices**
- 19 **Troubleshooting**
- 20 **Care & Cleaning / FCC**

Tools & Materials Required

CARRO



External hexagonal wrench



Phillips screwdriver



Step ladder

Package Contents

CARRO

Before installing, please check to make sure you have received all the necessary components for installation.

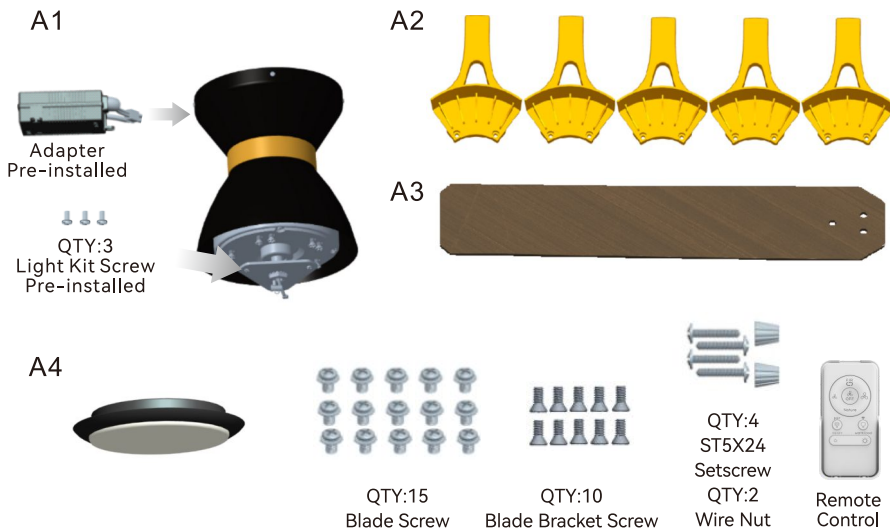

Installation: Motor Assembly

CARRO

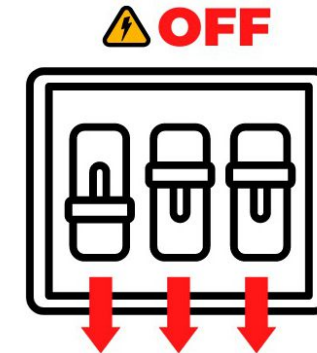

WARNING: To avoid serious injury or death, turn off the power at the circuit breaker before installing the fan.

1. Disassemble the Motor Assembly

Take the motor assembly out of the box, use a screwdriver to loosen the canopy screws and remove the mounting plate. Save the screws for later use.

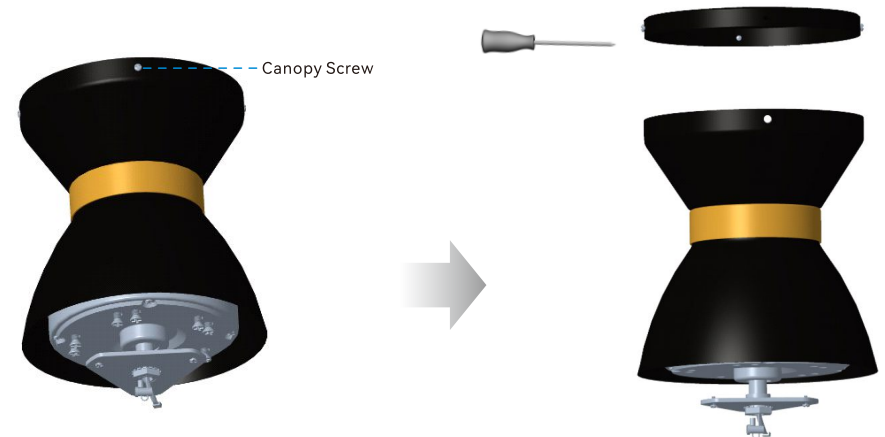

Fig 1.1

Fig 1.2

2. Install the Mounting Plate

You have two options for mounting plate installation. Pick which one works best for your location.

WARNING: Turn off the power from the breaker circuit first!

Note: For better fan performance, make sure the mounting plate is level.

Option 1: Fasten the mounting plate with the ST5×24 wood setscrews (included) when securing to the wooden ceiling beam or support structure with an approved electrical outlet box as shown in Fig 2.1.

Option 2: Use machine screws (provided with outlet box) and washers when securing to an existing ceiling fan-rated outlet box. If the mounting plate is installed at the outlet box, it should be installed on the outlet box with the screws that came with your outlet box itself. Pull the supply wires (the black, white and ground wires) out of the outlet box and through the hole in the mounting plate and lay them to the side.

WARNING: DO NOT use the plastic outlet box. Use only U.L. listed outlet boxes marked "Acceptable for Fan Support of 15.9 kg (35 lbs) or less".

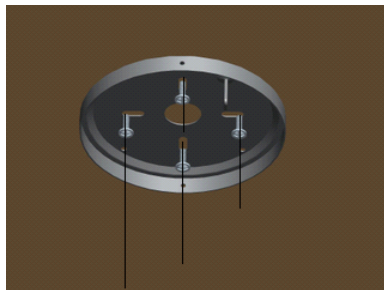

Fig 2.1

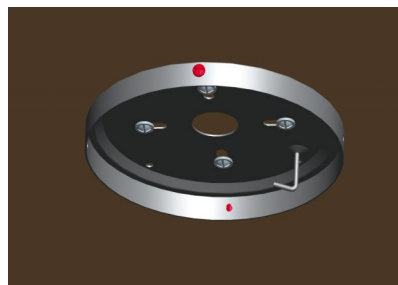

Fig 2.2

3. Hang the Fan

Carefully lift the fan-motor assembly. Hang the motor assembly on the hook of the mounting plate by utilizing one of the holes at the outer rim of the motor housing so that it is securely suspended.



4. Connect the Wiring

Connect the wire plug of the motor to the wire plug of the adapter and confirm the connection is secure.

The Green/Yellow wire from mounting plate connects with the supply Ground wire using the wire nut.

Connect the White wire of the Adapter to the supply White (Neutral) wire using a wire nut, connect the Black wire of the Adapter to the supply Black/Red (Hot/Live) wire using a wire nut.

Then hide them and the adapter inside the motor housing. (Make sure all the wires are connected to the correct colors as shown in Fig 4.1) Attach the other end of safety rope to a safe place.

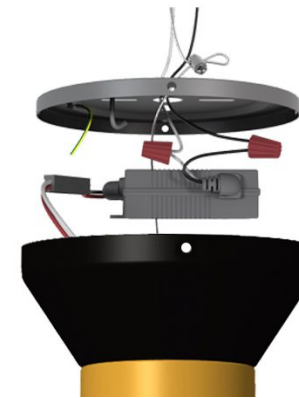

Fig 4.1

5. Secure the Fan

5.1 Reinstall two of the four canopy screws (located across from each other) that were removed in step 1 to the mounting plate, but DO NOT tighten them yet.

5.2 Using both hands, lift the fan body from the hook. While making sure the hook is not in the way of the adapter, align the two key slots in the top of the motor assembly with the two loosened screws on the mounting plate.

5.3 Push the fan motor assembly up and turn it counterclockwise to lock in the mounting plate. Tighten the two screws. Reinstall the other two canopy screws into the remaining two holes and tighten the four screws firmly.

WARNING: Falling fan hazard, make sure all screws are tightened to secure the fan motor assembly.



Fig 5.1

6. Install the Blade Brackets

6.1 Locate 10 blade bracket attachment screws in the hardware pack. Install the blade bracket screws to secure each blade bracket to the motor hub securely.

6.2 Repeat these steps for the remaining blade brackets. Make sure all the screws are firmly tightened.

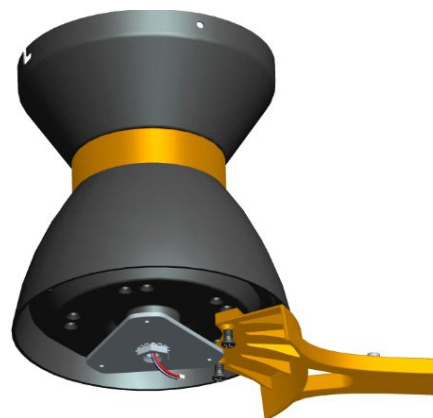

Fig 6.1

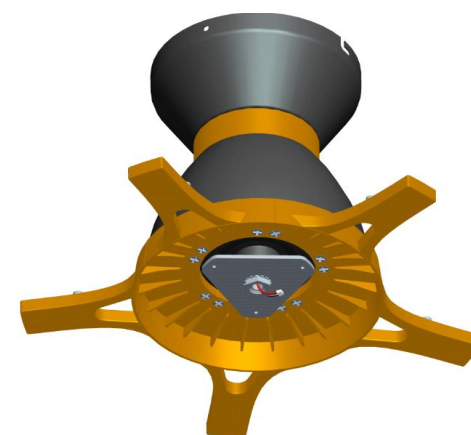

Fig 6.2

7. Install the Fan Blades

7.1 Locate 15 blade attachment screws with integrated washers in the hardware pack. Make sure the screw holes on each fan blade matches the corresponding holes on the blade bracket and tighten the blade screws. (See Fig 7.1)

7.2 Five blades installed. (See Fig 7.2)

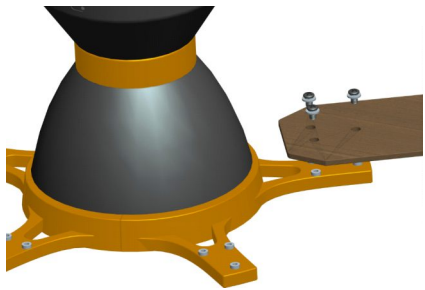

Fig 7.1

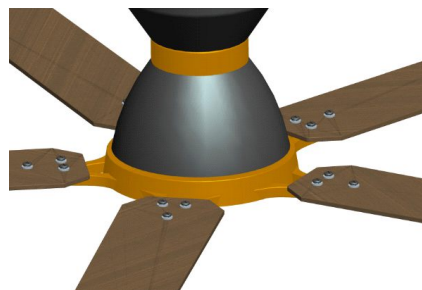

Fig 7.2

8. Disassemble the Light Assembly

8.1 Remove the light assembly out of the box and turn the lampshade counterclockwise to disassemble it as shown in Fig 8.1, and then remove the LED light kit out of the light kit pan directly as light kit is fixed by magnetic attraction.

8.2 The light assembly after disassembly is shown in Fig 8.2.

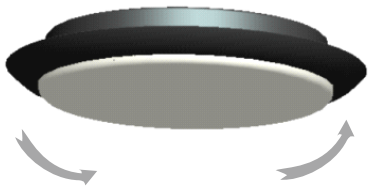

Fig 8.1

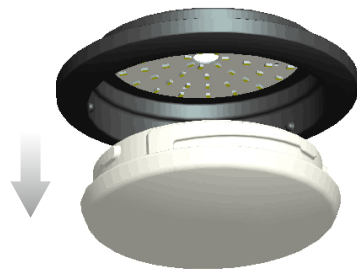

Fig 8.2

9. Install the Light Kit Pan & Light Kit

9.1 Remove one screw from the light kit plate of the motor assembly and loosen but DO NOT remove the other two screws.

Push the light kit pan to the light kit plate so that the two loosened screw heads fit into the keyhole slots. Feed the light wire connector plug through center hole of the light kit pan.

Turn the light kit pan clockwise. Reinstall the screw that was removed. Make sure all the screws are firmly tightened.

9.2 Allow the light wire connector plug to come through the light kit. Reinstall the light kit. The light kit is magnetically attracted to the pan with the help of magnets. Insert the light wire connector plug to the light kit terminal block.

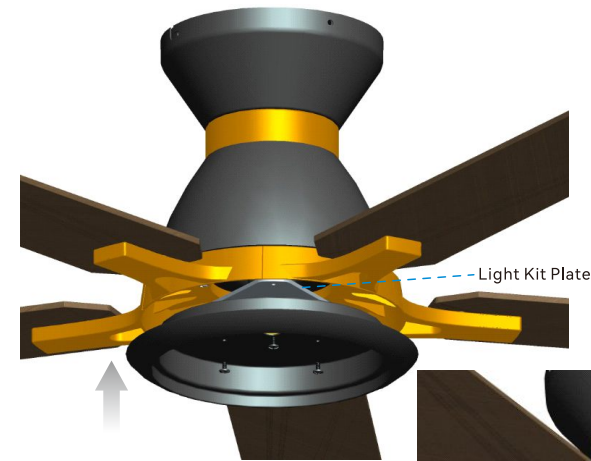

Fig 9.1

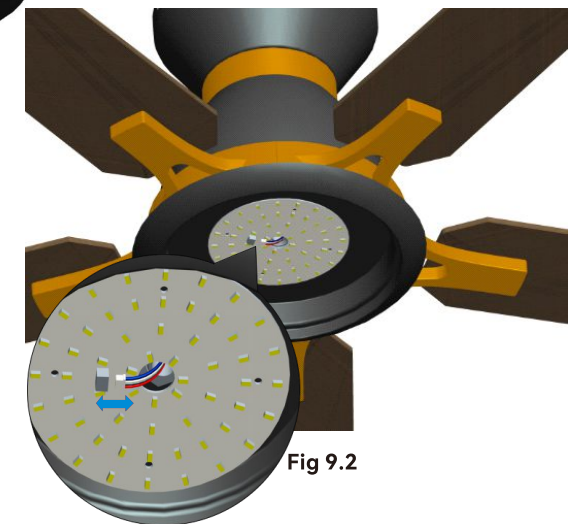

Fig 9.2

10. Install the Lampshade

Rotate the lampshade clockwise and securely lock into the light kit pan as shown in Fig 10.1.

WARNING: To prevent SERIOUS INJURY or DEATH, make sure that lampshade is properly secured. Allow the lampshade to cool completely before removing.

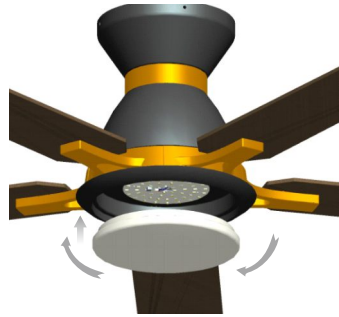

Fig 10.1

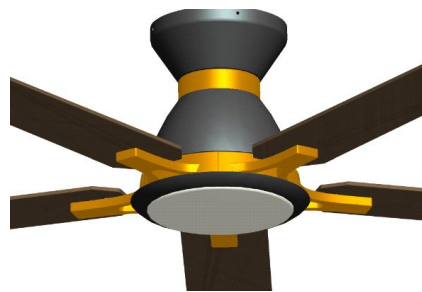



Fig 10.2

11. Power On

At this time, the ceiling fan has been installed. Turn on the power supply from the breaker circuit of the main switch or the room where the ceiling fan is installed. After the power is on, observe whether the fan light is on.



Pair the Remote Control to Your Fan

Power on the fan and pair the remote to the fan within 1 min. To pair remote to fan, press and hold  button for 3-5 secs to pair remote to the fan. Successful pairing will trigger the fan light off.

Remote Control Button Definitions



Turns the fan off.



Switches between summer mode and winter mode.

· Summer mode - (Counter-clockwise)

A downward airflow creates a cooling effect.

· Winter mode - (Clockwise)

An upward airflow moves warm air away from the ceiling area and redistributes it around the living space.



Turns the fan on and decreases fan speed.



Turns the fan on and Increases fan speed.

Nature

Switches the fan speed between nature mode and normal mode. Simulates a natural breeze, gentle enough not to disturb while you sleep.



Turns the lights on or off and RF pairing.

Note: Power on the fan and pair the remote to the fan within 1 min. To pair remote to fan, press and hold  button for 3-5 secs to pair remote to the fan. Successful pairing will trigger the fan light off.



Switches between warm light and cool light. WIFI Troubleshooting.

Note: Press/hold button for 5 sec. The fan will switch to AP Mode, then select AP Mode on APP, follow the APP control instructions and enable fan Wi-Fi.



Press/Hold button to decrease the light intensity.



Press/Hold to button to increase the light intensity.

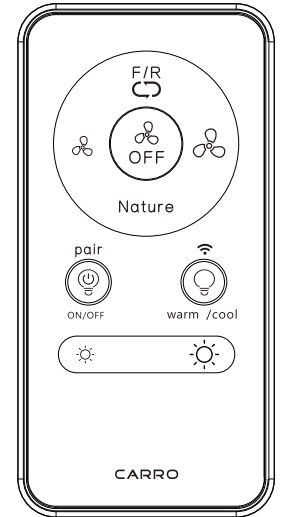

WARNING: Do not expose the remote control to direct contact with water.

1. First download the free Carro Home App from the App Store or Google Play or scan the QR Code below.

Note: This ceiling fan needs to use 2.4Ghz WIFI to work when connecting the device, and after connecting, it can use the 5Ghz or 2.4Ghz.

2. Open the Carro Home App to create your account. The account with "Carro Home" can be registered through E-mail or Mobile phone.

3. Connect the device to the Carro Home App (Four ways to connect) :

①Bluetooth Connect (WIFI & Bluetooth On)

- a. Press "+" button into the device list, then a window will pop up to show you some devices can be connected.
- b. Click "Go to add" (If you click "Do not add" by mistake, please see "Do not add" steps).
- c. Choose the device.
- d. Connect to your home WIFI, then back to the app and wait for connecting.

"Do not add" steps:

- a. Select "Electrical" (smart switch) or "Air Circulation" (smart ceiling fan) on the sidebar menu then select "Ceiling Fan Switch" or "Ceiling Fan" and tap next.
- b. Connect to your home WIFI and tap "Next" to wait for connection.

②Auto Scan (WIFI & Bluetooth On)

- a. Press "+" button into the device list.
- b. Tap "Auto Scan" on the top.
- c. Wait for the device to appear and tap "Next".
- d. Press "+" button to add device.
- e. Connect to your home WIFI.
- f. Wait for connection.



③WIFI Connect-EZ Mode (WIFI On & Bluetooth Off)

- a. Press "+" button to select "Electrical" (smart switch) or "Air Circulation" (smart ceiling fan) on the sidebar menu then select "Ceiling Fan Switch" or "Ceiling Fan" and tap next.
- b. Connect to your home WIFI (Only for 2.4Ghz).
- c. EZ Mode is set as default, just tap "Next" button to wait for the connection to complete.

④WIFI Connect-AP Mode (WIFI On & Bluetooth Off) :

- a. Smart ceiling fan: Press and hold the WIFI button on the remote for 5 seconds for AP Mode. Smart switch: Press and hold the "OFF" button for 10 seconds till the indicator light blinks slowly to enter into AP Mode.
- b. Press "+" button to select "Electrical" (smart switch) or "Air Circulation" (smart ceiling fan) on the sidebar menu then select "Ceiling Fan Switch" or "Ceiling Fan" and tap next.
- c. Connect to your home WIFI (Only for 2.4Ghz).
- d. Choose AP Mode.
- e. Press "Next" button to go to connect the fan's WIFI signal.
- f. Choose the fan's WIFI signal "CarroHome-XXXX" then go back to the app.
- g. Wait for connection.

Connecting to Smart Devices

1. Connect the device to the Alexa:
 - a. Make sure you have connected the device to the app and it is working normally.
 - b. Open Alexa app, go to the skill to search "Carro Home" skill.
 - c. Link the skill, log in with your Carro Home App account and password, then authorize and connect with Carro Home App.
 - d. Then the Alexa will find the device automatically.
2. Connect the device to the Google Home:
 - a. Make sure you have connected the device to the app and it is working normally.
 - b. Open Google Home app, Set up a device, choose "Works with Google".
 - c. Search "Carro Home", log in with your Carro Home App account and password, then authorize and connect with Carro Home App.
 - d. Then the Google Assistant will find the device automatically.
3. Connect the device to the Siri shortcuts:
 - a. Make sure you have connected the device to the app and it is working normally.
 - b. Tap "Smart" on the main menu.
 - c. Tap "+" button.
 - d. Tap "launch Tap To Run".
 - e. Tap "Run the device".
 - f. Choose the device you want to control by Siri.
 - g. Select the function you want to control by Siri.
 - h. Then save it.
 - i. Add to Siri, choose the scene you just made, Add to Siri.
 - j. Enter the sentence you want to say to make the device works, Add to Siri.

Try these troubleshooting steps before contacting Customer Service. For additional operation, maintenance, and troubleshooting information, please contact our customer service center.

SYMPTOM	POSSIBLE SOLUTION
Fan not spinning	<p>① Make sure the fan is getting power. ② Check your circuit breaker or fuse panel and wall switch for functionality. ③ Check to make sure the fan wires are correctly connected to the house wires. ④ Remote control must be paired with the fan within 1 minute after connecting the fan to the electricity. ⑤ If you have paired the app but the fan still does not work (light and fan both didn't work) or couldn't pair the app to the fan, try to reset the fan: to reset the fan, cut the power for 10 minutes, then turn the power on and press the pairing button  on the remote for 3-5 seconds until the fan light turns off, then pair the Carro Home App again. ⑥ Use a multi-meter and test the adapter wiring harness to see if there is any electrical output. ⑦ All the pin wiring on the circuit board must be inserted tight and in the correct position. ⑧ Remote needs to be paired with the fan first. ⑨ Make sure the fan blades spin freely. ⑩ If you're using a wall control, check the power to the breaker from your control and try working your ceiling fan manually. (Normal switch only for the fan power on/off)</p>
Fan light not working	<p>① Make sure LED wires are connected to the circuit board. ② Make sure the whole fan is powered.</p>
The fan is noisy and wobbling	<p>① Check if the blade screws are NOT rubbing against any part of the motor housing. ② Check the pin wires are NOT connected against any moving parts. ③ Check the down fan cup is NOT hitting the motor. ④ Confirm the canopy is NOT touching the ceiling while the fan is in operation. ⑤ Check the down rod is NOT slanted. ⑥ Tighten any loose screws on the light kit, fan blades, motor coupling, down rod, brackets and mounting hardware. ⑦ Confirm the hanger ball is firmly seated in the mounting bracket. ⑧ The ceiling beam must meet the minimum tensile test strength of 30KG for installation. ⑨ Make sure the blades and brackets are NOT bent or deformed. ⑩ Verify the wire connections are not rattling against each other. ⑪ Verify the fan blades are not cracked. If the fan blades are cracked, replace the damaged blades with a new blade set from the same brand as your ceiling fan to ensure compatibility. ⑫ Confirm the light kit is NOT slanting and hitting the motor.</p>
Unable to pair remote and app	<p>① Check if the wires are connected in the correct position or not. ② Check the batteries in the remote. ③ Disconnect the power for 10 minutes, reconnect the power and pair the remote with the fan immediately, within 1 minute. Also try pairing the app to reconnect. ④ The WiFi must be 2.4Ghz, incompatible with 5Ghz WiFi or combined with 5Ghz. ⑤ App must be the newest version. ⑥ Connect with correct app "Carro Home".</p>
Fan or light turning on or off by themselves	<p>① Confirm the circuit breaker is not malfunctioning. ② Verify the wire connections are not frayed. ③ Check the app is not set to a timer or schedule. ④ Cut the fan power for 10 minutes then power on again. ⑤ All the pin wiring on the circuit board must be inserted tight and in the correct position.</p>

- 1 Check the support connections, brackets, and blade attachments twice a year. Make sure they are secure. Because of the fan's natural movement, some connections may become loose over time. It is not necessary to remove the fan from the ceiling.
2. Clean your fan periodically. Use only a soft brush or lint-free cloth to avoid scratching the finish. The plating is sealed with a lacquer to minimize discoloration or tarnishing.
3. (Optional) Apply a light coat of furniture polish to the wood blades.
4. (Optional) Cover small scratches with a light application of shoe polish.

DO NOT:

1. Use water when cleaning. Water could damage the motor, or the wood, or possibly cause an electrical shock.
2. Apply oil to your fan or motor. The motor has permanently lubricated sealed ball bearings.

WARNING: Power off the fan before performing maintenance or cleaning the fan.

FCC Statement

Note: This equipment has been tested and found to comply with the limits for a Class B digital device, pursuant to part 15 of the FCC Rules. These limits are designed to provide reasonable protection against harmful interference in a residential installation. This equipment generates, uses and can radiate radio frequency energy and, if not installed and used in accordance with the instructions, may cause harmful interference to radio communications. However, there is no guarantee that interference will not occur in a particular installation. If this equipment does cause harmful interference to radio or television reception, which can be determined by turning the equipment off and on, the user is encouraged to try to correct the interference by one or more of the following measures:

- Reorient or relocate the receiving antenna.
- Increase the separation between the equipment and receiver.
- Connect the equipment into an outlet on a circuit different from that to which the receiver is connected.
- Consult the dealer or an experienced radio/TV technician for help.

WARNING: Changes or modifications to this unit not expressly approved by the party responsible for compliance could void the user's authority to operate the equipment.