

INSTALLATION & USER MANUAL

CEILING FAN WITH LIGHT

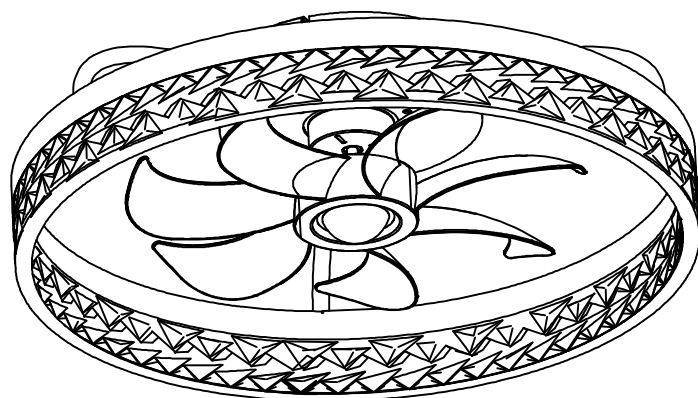

ITEM# 33075-BK

Customer Service: support @ breezary.com

Table of Contents

Table of Contents.....	2	Installation Instructions	4–8
Safety Information.....	2	Remote Control Operation.....	9
Dimension Reference.....	3	Troubleshooting.....	10
Hardware Included.....	3		
Fan Parts Included.....	3		

Safety Information

READ AND SAVE THESE INSTRUCTIONS.

1. To reduce the risk of electric shock, ensure electricity has been turned off at the circuit breaker or fuse box before you begin.
2. All wiring must be in accordance with the National Electrical Code “ANSI/NFPA 70” and local electrical codes. Electrical installation should be performed by a qualified licensed electrician.
3. The outlet box and support structure must be securely mounted and capable of reliably supporting a minimum of 35 lbs (15.9 kg). Use only UL Listed outlet boxes marked “Acceptable for Fan Support of 35 lbs. (15.9 kg) or less.”
4. Do not place objects in the path of the blades.
5. To clean the fixture, turn off the power, wait for it to cool, and wipe the fixture with a clean dry, soft cloth.
6. After making electrical connections, spliced conductors should be turned upward and pushed carefully up into the outlet box. The wires should be spread apart with the grounded conductor and the equipment-grounding conductor on one side of the outlet box and ungrounded conductor on the other side of the outlet box.
7. All screws must be checked and retightened where necessary before installation.



WARNING: To reduce the risk of electrical shock or fire, not use this fan with any solid-state fan speed control device. It will permanently damage the electronic circuitry.



WARNING: To reduce the risk of fire or injury do not use this product in conjunction with any variable (rheostat) wall control.



WARNING: To reduce the risk of personal injury, do not bend the blade brackets when installing the rackets balancing the blades, or cleaning the fan. Do not insert objects.



WARNING: To reduce the risk of fire, electric shock or personal injury, mount to outlet box marked “acceptable for fan support of 35 lbs. (15.9 Kg) or less” and use screws provided with the outlet box.



WARNING: To avoid possible electrical shock, turn the electricity off at the main fuse box before wiring.



WARNING: To reduce the risk of electrical shock, this must be installed with an isolating wall control / switch.



CAUTION: To reduce the risk of personal injury, use only the screws provided with the outlet box.



CAUTION: Please use carefully when working around or cleaning the fan to avoid injury or damage of fan.



CAUTION: The fan must be mounted with a minimum of 7.5 feet (2.3 Meter) clearance from the trailing edge of the blades to the floor.





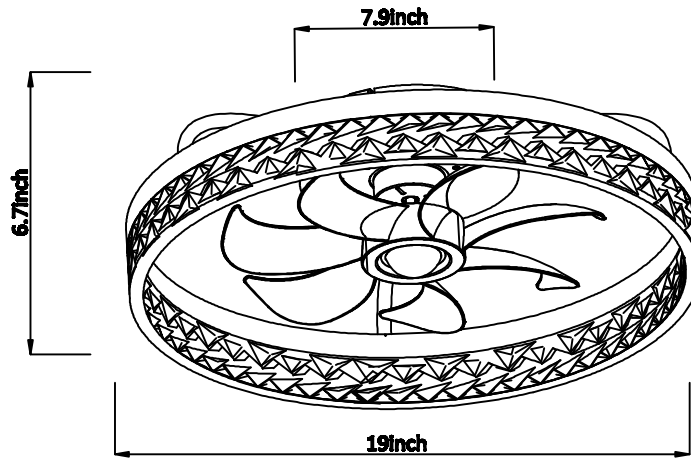

CAUTION: Changes or modifications not expressly approved by the party responsible for compliance could void the user’s authority to operate the equipment.

Dimension Reference

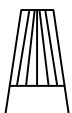

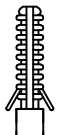
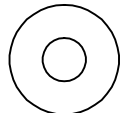
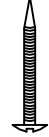

Hardware Included

1  Wire Nut	2  J-Box Screw	3  Expansion rubber plug
4  Washer	5  Self - Tapping Screw	6  Expansion Screw

Hardware Package	Quantity
1. Wire Nut	3
2. J-Box Screw	2
3. Expansion rubber plug	4
4. Washer	4
5. Self - Tapping Screw	4
6. Expansion Screw	4

Fan Parts Included

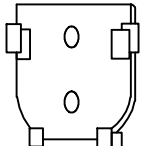
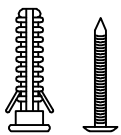
1  Ceiling Fan Housing	2  Remote Control
3  Remote Control Wall Plate	4  Remote Control Accessory Pack

Item Name	Quantity
1. Ceiling Fan Housing	1
2. Remote Control	1
3. Remote Control Wall Plate	1
4. Remote Control Accessory Plate	1

Installation Instructions

Energy Saving Usage

- Ceiling fan performance and energy savings rely heavily on the proper installation and use of the ceiling fan. Here are a few tips to ensure efficient product performance.

Choosing the Appropriate Mounting Location

Ceiling fans should be installed or mounted in the middle of the room and positioned at least 7.5 feet above the floor and 18 inches away from the walls. If the ceiling height allows, it is recommended to install the fan 7.5~9 feet above the floor to achieve optimal airflow.

Turn Off When Not in the Room

If the room is unoccupied, turn off the ceiling fan to save energy.

Using the Ceiling Fan Year Round

Summer Season: Use the ceiling fan in the counterclockwise direction. The airflow created by the ceiling fan produces a wind-chill effect, making you feel cooler. Select a fan speed that provides a comfortable breeze; lower speeds consume less energy.

Winter Season: Reverse the motor and operate the ceiling fan at a low speed in the clockwise direction. This produces a gentle updraft, which pushes the warm air near the ceiling down into the occupied space. Remember to adjust your thermostat when using your ceiling fan. This simple step can lead to additional energy and cost savings.

Installation Instructions

Electrical and Structural Requirements

- Your new ceiling fan will require a grounded electrical supply line of AC 110-130V/60Hz and a 15 Amp circuit. According to electrical codes, it is necessary to use a fan-rated outlet box to support the additional weight and motion associated with a ceiling fan. A fan-rated box will be clearly labeled as such and is typically designed to support ceiling fans weighing up to 35 pounds. Fan-rated outlet boxes are available in various ratings and designs. It is essential to ensure that the rating of your ceiling fan outlet box meets the requirements for the specific ceiling fan you are installing.
- If your fan is to replace an existing light fixture, turn power off at the main fuse box and remove the existing light fixture.

WARNING

To ensure safety and prevent potential electrical shock, it is not sufficient to simply turn off the wall switch. Prior to wiring, make sure to turn off the electricity at the main fuse box. All wiring should be done in accordance with national and local electrical codes. Additionally, it is important to properly ground the ceiling fan as a precautionary measure against possible electrical shock. Following these guidelines will help ensure the safe installation and operation of your ceiling fan.

WARNING

Do not use a variable (rheostat) wall controller or dimmer switch to operate this fan. Doing so can cause damage to the ceiling fan's remote control unit. It is recommended to only use the provided remote control.

Installation Instructions

Installation

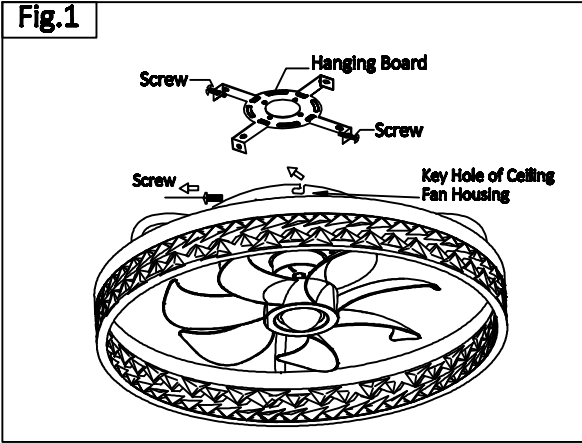

Take out the hanging board
Remove the screw from the circular hole. Keep the screw that removed aside for use later.
Loosen the other two screws from the two key holes approximately 1/4 turn ,Turn the key holes of the ceiling fan housing from the two screws loosened previously and remove the hanging board from the ceiling fan.

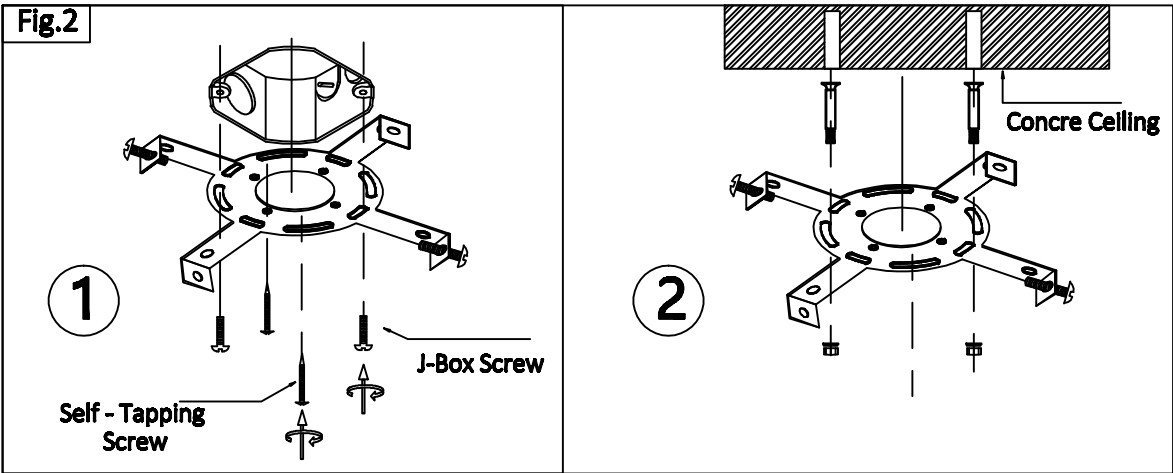

- ① Attach the hanging board to the outlet box (not included) with the two jbox screws provided. Secure the hanging board to the ceiling with the two self-tapping screws provided.
- ② Please drill $\varnothing 8\text{mm}$ hole on the concrete ceiling, and insert expansion screw. Align bracket with the hole, then tighten with nut.

Installation Instructions

Fig.3

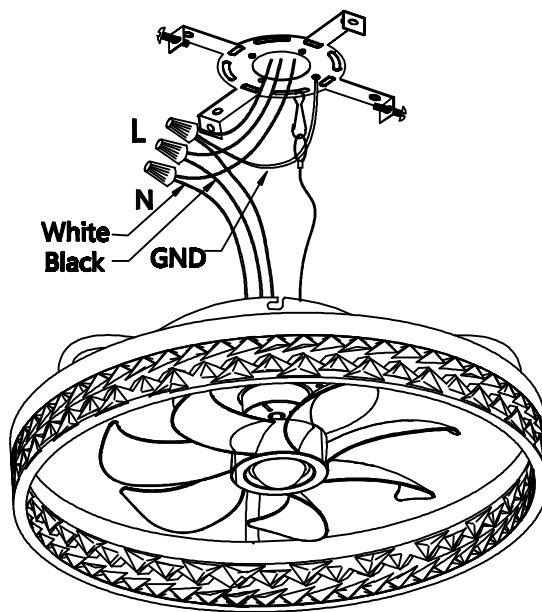

- **Wiring**

TIPS: To facilitate wiring, please use a safety rope to hang the ceiling fan.
Connect the "Neutral wire" (white wire) from the ceiling to the white wire of ceiling fan.

Connect the "Live wire" (black wire) from the ceiling to the black wire of ceiling fan.

Connect the "Ground wire"

Connect the ground wire (Green) on the hanging board and the ground wire (green) on the fan with the ground wire interface on the ceiling.

Installation Instructions

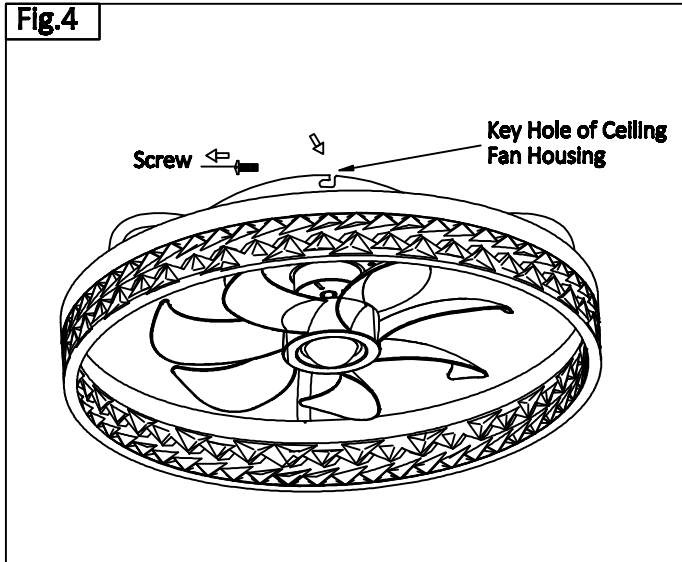



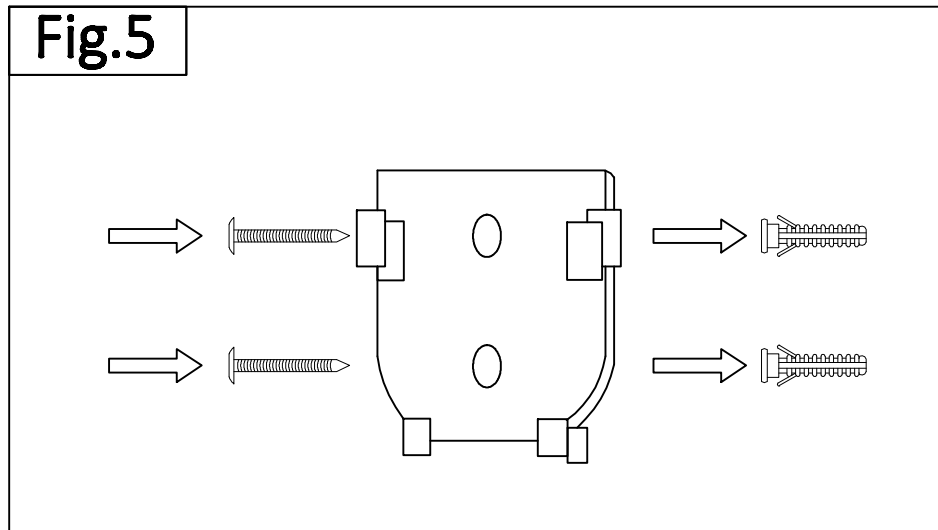





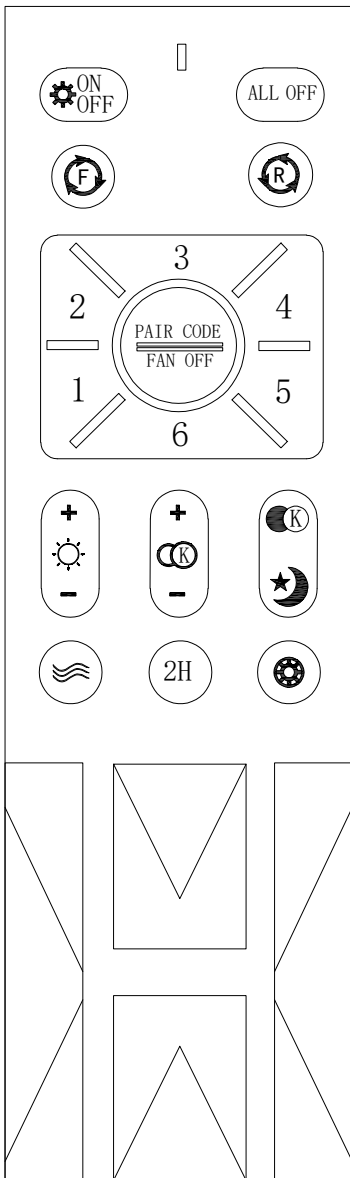







Place the two key holes from the ceiling fan housing over the two screws previously loosened from the hanging board. Turn the ceiling fan housing until it locks in place at the end of the key holes. Secure by tightening the two screws previously loosened and the one screw previously removed.



Installing wall Plate

Attach wall plate using the two screws and two plastic anchors provided in remote control accessory pack.



-  Light ON/OFF
-  ALL OFF
-  Color Temperature Switch
-  Night Light
-  Click or long press this button to increase the brightness
-  Click or long press this button to decrease the brightness
-  Long press this button to increase color temperature
-  Long press this button to decrease color temperature
-  Fan Forward
-  Fan Reverse
-  Turn off automatically after 2-hour countdown
-  Fan speed, 1 is the lowest, 6 is the highest
-  Nature Wind
-  Fan off and code matching
-  Blank

Note:

The remote control has completed the learning and pairing steps before leaving the factory, and can be used directly after installation. Add or replace if necessary you only need to buy a new remote control.

Remote control pairing method: within 5 seconds upon turning on , long press "FAN OFF" button, the light flashes 2 times , then the action is done. If not , turn off the power, and repeat it after 1 minute.

Code clear : within 5 seconds upon turning on , long press "ON/ OFF" button, the light flashes 2 times, then the action is done.

The remote control needs 2pcs AAA batteries (not include) if your remote control does not control the fan and lights ,please follow the steps below to undo the fault.

Step 1: Replace the battery of the remote control.

Step 2: Try to program the remote control.

Troubleshooting

Problem	Solution
The fan will not start.	<ul style="list-style-type: none"> □ Check the main and branch circuit fuses or breakers. □ Check the line wire connections to the fan. □ Check the battery in the remote control. □ Ensure you are in the normal range of 10-20 feet. □ Turn the main power source off and then restore the power to the unit. Within 3 seconds of turning the fan's AC power ON, press and hold the "ON/OFF" button for 5 seconds to complete the "pairing process". Once the receiver has detected the set frequency, the LED light of the fan will blink once.
The fan is noisy.	<ul style="list-style-type: none"> □ Ensure all motor housing screws are snug. □ Ensure the wire nut connections are not rattling against each other. □ Allow a 24-hour "breaking in" period. Most noises associated with a new fan disappear during this time. □ Ensure the canopy is a short distance from the ceiling. It should not touch the ceiling. □ Ensure your outlet box is secure and rubber isolator pads were used between the mounting plate and outlet box.
The fan is wobbles.	<ul style="list-style-type: none"> □ This fan has a one-piece blade design, fan blade balancing kit is not applicable to this product. □ If the fan wobbles, disconnect the power by removing the fuses or turning off the circuit breakers from the main power source, then check with the following: Remove the grille from the fan body by first removing the decorative cap at the center of the grille by rotating the decorative cap anti-clockwise, use a Philips screwdriver to tighten the screw inside of the plastic threaded nipple. □ If the wobbling persists, adjust the angle of the grille slightly to make it more perpendicular to the ground. □ If the problem persists, please contact our customer service.
Fan moves backwards and forwards when turned on.	<ul style="list-style-type: none"> □ This is normal start-up procedure for DC motor fans. The partial movement during start-up is the result of the DC motor aligning the internal magnetic poles for proper motor operation. This design saves electricity and allows the fan to operate much quieter than standard AC motor fans.