

Product ID. QNTUK

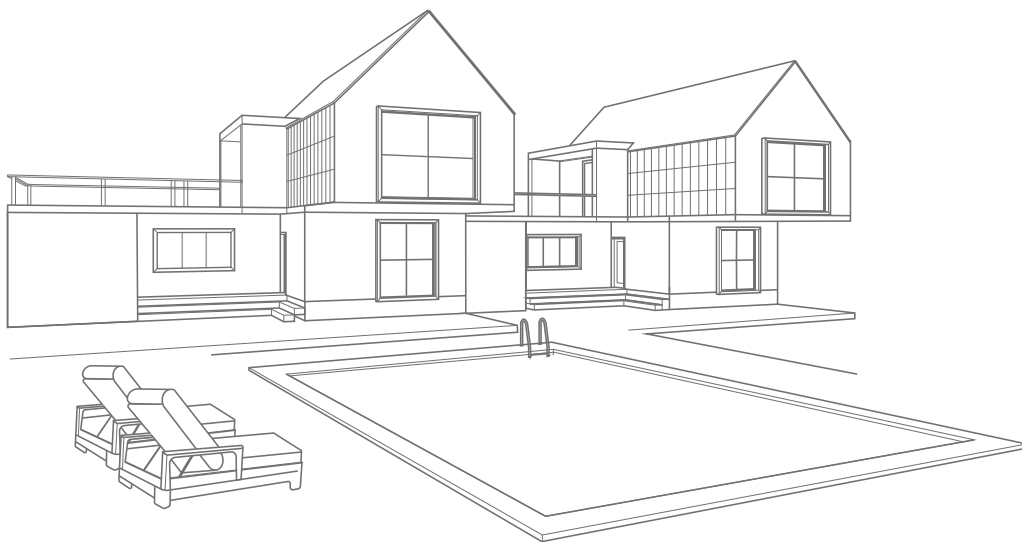

Scan for Support
support@garvee.com



Description and location of machine parts

FIG. A & B

- 01 Table
- 02 Disc
- 03 Dividing knife
- 04 Protective guard
- 05 On/off switch
- 06 Water tub
- 07 Parallel guide rods
- 08 Angle guide
- 09 Tank drain plug
- 10 -
- 11 Adjustment of angle
- 12 Disc mounting keys
- 13 Cable storage
- 14 -
- 15 -
- 16 -

FIG. A & B

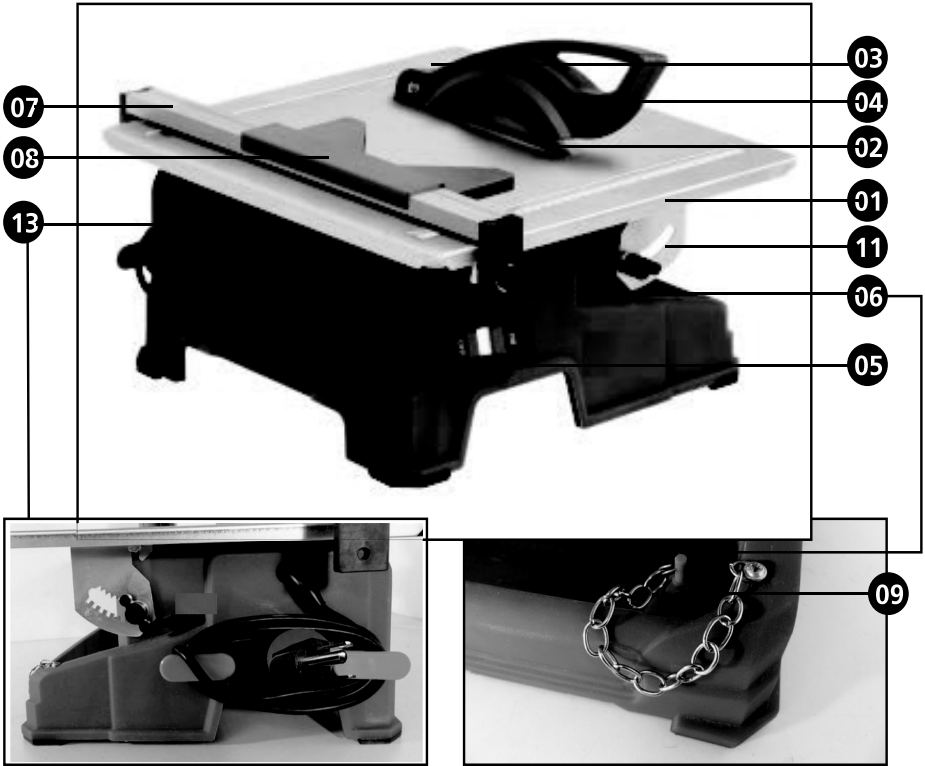

FIG. C

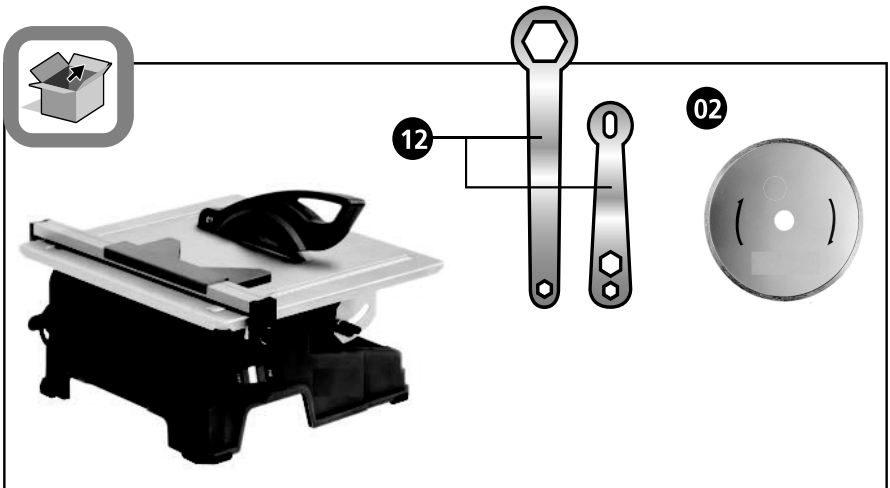
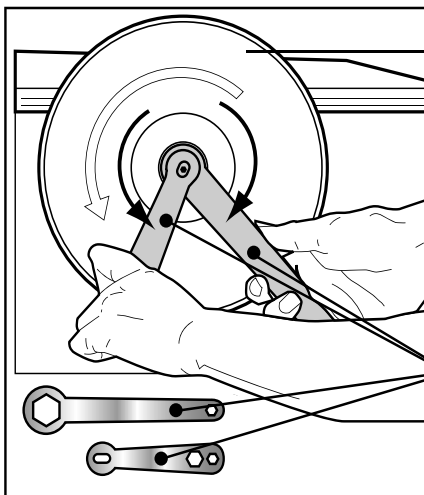
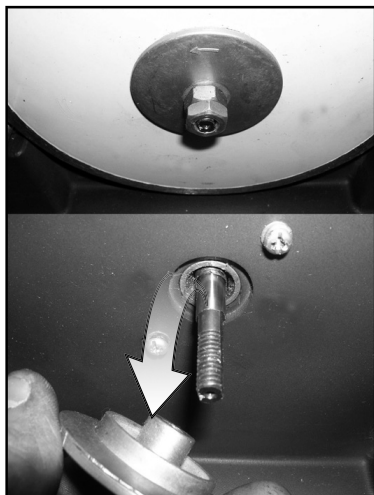
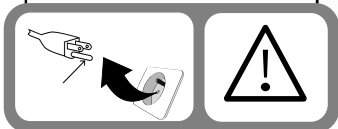
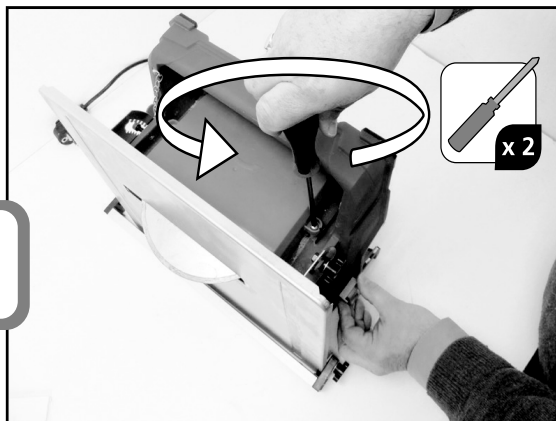

FIG. D

01



02

12

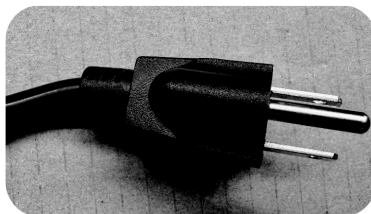
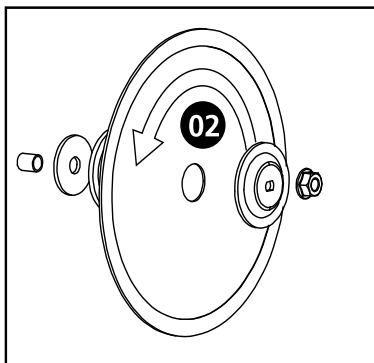

02

03

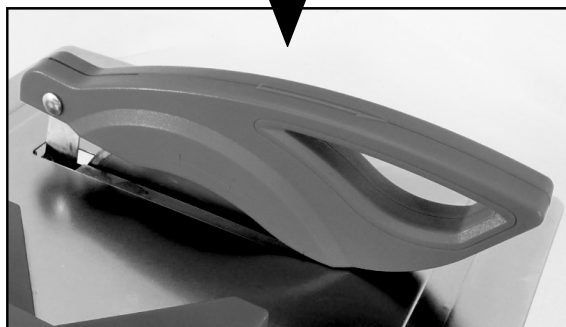
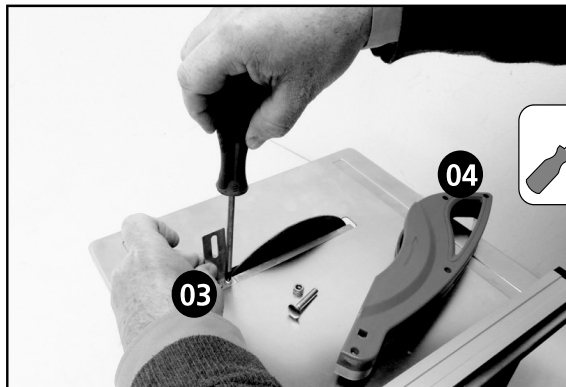

08

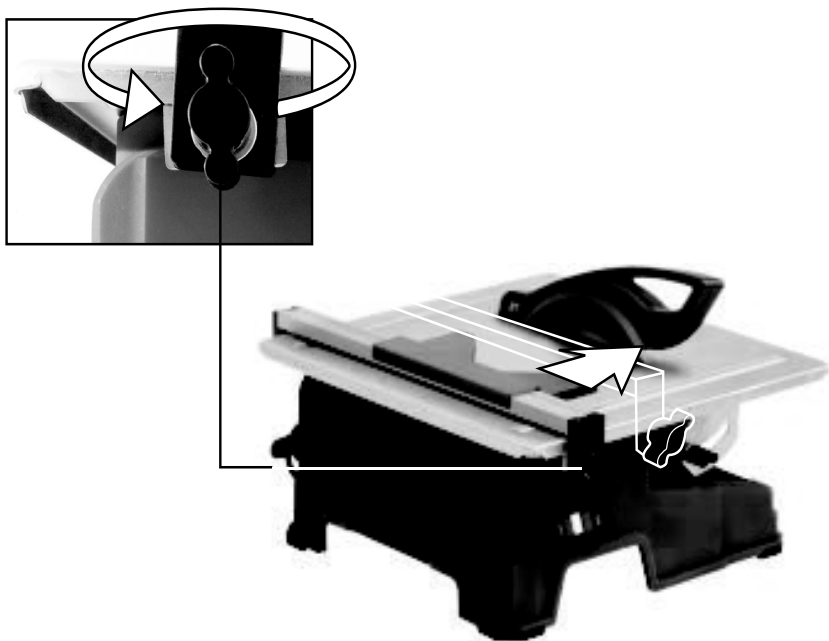
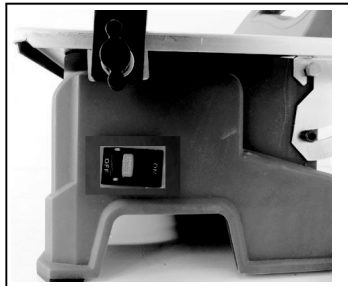
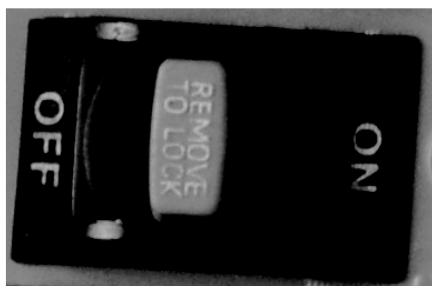
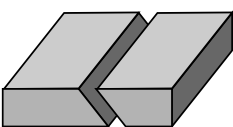
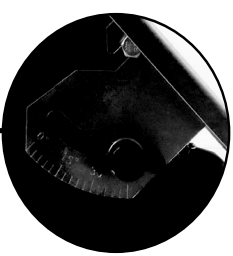
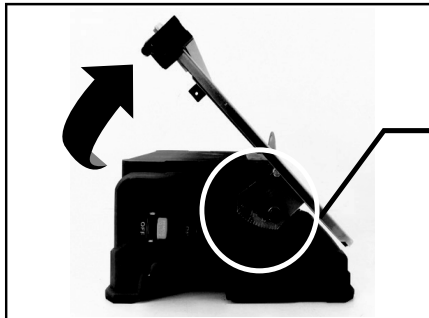
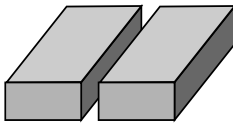
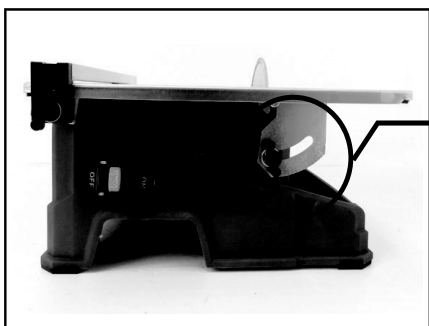

FIG. E

01



02



04

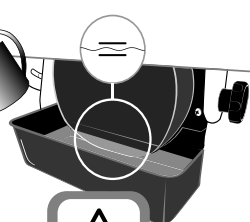
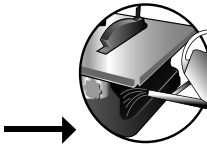
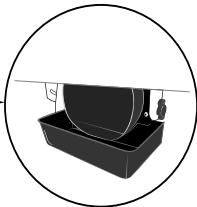
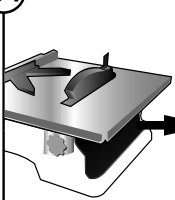

05

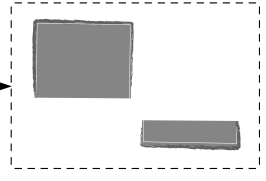
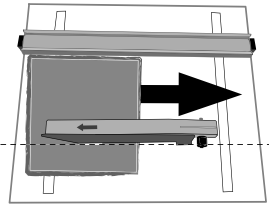

06

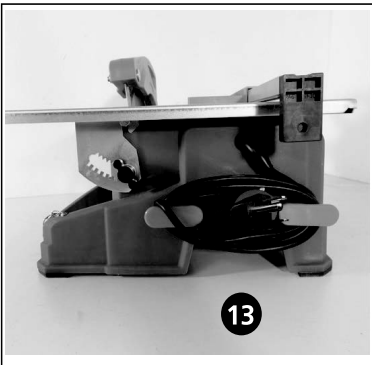
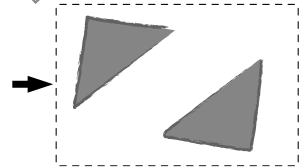
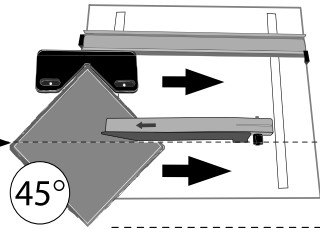
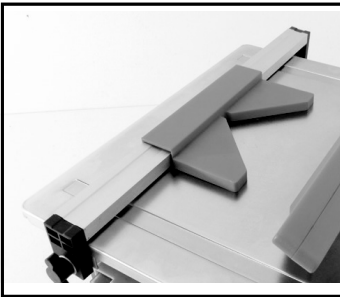



NOMINAL FREQUENCY AND POWER:
TENSION ET FRÉQUENCE ASSIGNÉE:
AANGEWZEN SPANNING EN FREQUENTIE:TENSIÓN Y FRECUENCIA FIJADA:
TENSÃO E FREQUÊNCIA FIXA:
TENSIONE E FREQUENZA ASSEGNATA:

120 V ~ 60 Hz



NOMINAL POWER:
PUISSANCE ASSIGNÉE:
ONBELAST TOERENTAL:POTENCIA FIJADA:
POTÊNCIA ASSINADA:
POTENZA ASSEGNATA:

450 W (52 30 mm)



NO-LOAD SPEED:
VITESSE À VIDE:
LEERLAUFDREHZAHL:
VELOCIDAD VACÍA:
VELOCITÀ A VUOTO:
VELOCIDADE NO VÁCUO:

3450 min⁻¹



WEIGHT :
POIDS :
GEWICHT :PESO :
PESO :
PESO :

7,5 kg



DISK SIZE:
DIMENSIONS DISQUE:
DISK SIZE:
TAMAÑO DEL DISCO:
TAMANHO DO DISCO:
DIMENSIONE DEL DISCO:

Ø 180 mm

	<p>BORE SIZE: ALÉSAGE DISQUE: DISK BOHRUNG: CALIBRE DEL DISCO: CALIBRE DO DISCO: ALESAGGIO DEL DISCO:</p>	<p>Ø 22,2 mm</p>
--	--	-------------------------







	<p>TABLE SIZES: DIMENSIONS DE TABLE: TAFELAFMETINGEN: DIMENSIONES DE LA MESA: AS DIMENSÕES DA TABELA: DIMENSIONI TAVOLA:</p>	<p>360 X 330 mm</p>
--	---	----------------------------

		<p>90° = 34 mm / 45° = 17 mm</p>
--	--	---

		<p>0-4.5°</p>
--	--	----------------------

	<p>SUBJECTED TO RECYCLING : SOUJIS À RECYCLAGE : NIET WEGWERPEN : SOTTOPOSTI A RICICLAGGIO : SUJEITOS À RECICLAGEM : SOTTOPOSTI A RICICLAGGIO :</p>	<p>X</p>
--	--	-----------------

	<p>RECYCLABLE, SUBJECT TO RECYCLING: RECYCLABLE, SOUMIS AU TRI SÉLECTIF: RECYCLEBAAR, ONDER VOORBEHOUD VAN HET SORTEREN: RECICLABLE, SIN PERJUICIO DE LA CLASIFICACIÓN: RECICLÁVEL, SUJEITO A TRIAGEM: RICICLABILE, SOGGETTO A CERNITA:</p>	<p>X</p>
--	--	-----------------

   	<p> USAR LUVAS: WEAR PROTECTIVE EYEWEAR : WEAR A DUST MASK : WEAR HEARING PROTECTIVE EQUIPMENT:WEAR GLOVES : STAUBSCHUTZMASKE TRAGEN : GEHÖRSCHUTZ TRAGEN: HANDSCHUHE TRAGEN: DRAAG EEN VEILIGHEIDSBRIL : DRAAG EEN STOFMASKER : DRAAG GEHOORBESCHERMERS: DRAAG HANDSCHOENEN:Ľ LLEVAR PUESTAS GAFAS PROTECTORAS : LLEVAR PUESTA UNA CARETA DE PROTECCIÓN CONTRA EL POLVO : LLEVAR PUESTA UNA PROTECCIÓN AUDITIVA: USAR GUANTESPORTARE DE GLI OCCHIALI DI SICUREZZA : INDOSSARE UNA MASCHERINA ANTI-POLVERE : PORTARE UNA PROTEZIONE Uditiva:INDOSSARE I GUANTI: UTILIZAR ÓCULOS DE SEGURANÇA : UTILIZAR UMA MÁSCARA ANTI-POEIRA : UTILIZAR UMA PROTECÇÃO AUDITIVA: </p>	X
	<p>READ THE INSTRUCTIONS BEFORE USE :</p>	X
	<p> DANGER : GEVAAR : PELIGRO : PERIGO : PERICOLO : DANGER : </p>	X

TC180P

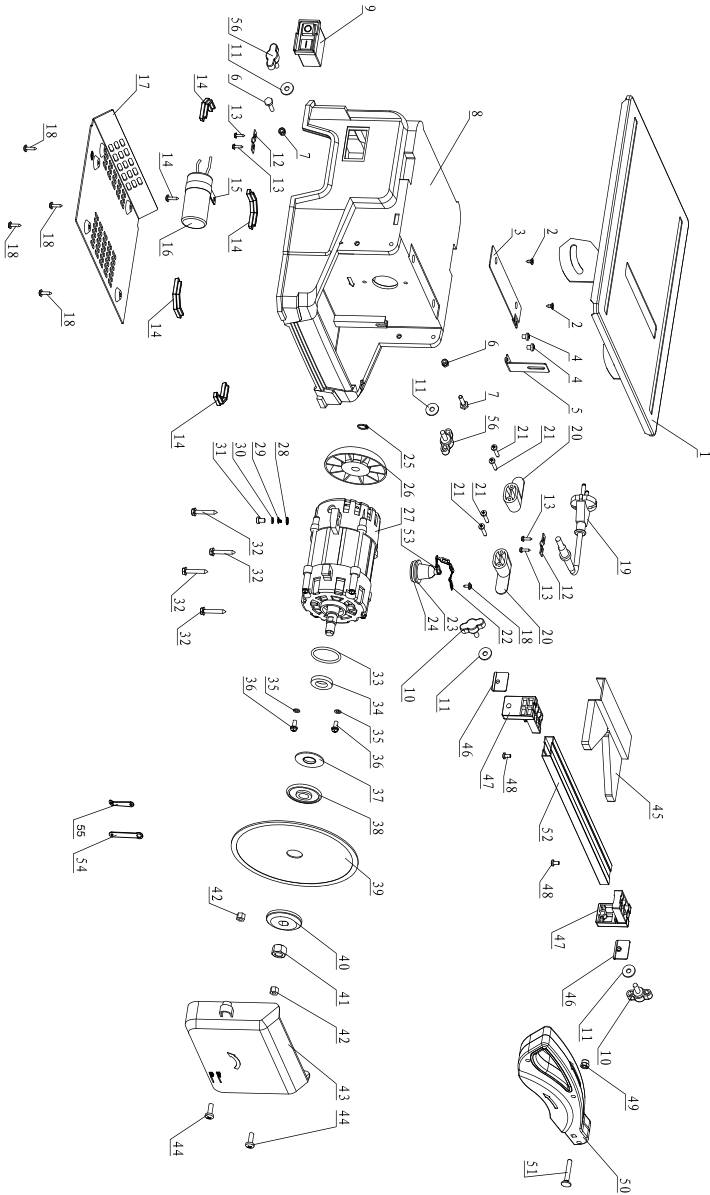

Limited Liability & Warning

No Unauthorized Modifications/Repairs: Do not modify or attempt to repair this product unless you are an authorized technician. Unauthorized actions may create hazards and void all warranties

Misuse & Non-Compliance: We are not liable for any injury, damage, or loss resulting from:

- (a) misuse, abuse, neglect, or improper installation;
- (b) failure to follow instructions or safety precautions;
- (c) use of unauthorized parts/accessories;
- (d) unauthorized modifications/repairs;
- (e) accidents, natural disasters, or external causes.

If you doubt any step of installation or operation, stop using the product and contact authorized service or the customer support.

LIMITACIÓN DE RESPONSABILIDAD Y ADVERTENCIA

Modificaciones o Reparaciones No Autorizadas: NO modifique ni intente reparar este producto a menos que sea un técnico autorizado. Las acciones no autorizadas pueden generar riesgos y anularán todas las garantías.

Uso Indebido e Incumplimiento: No asumimos responsabilidad alguna por lesiones, daños o pérdidas que resulten de:

- (a) uso indebido, abuso, negligencia o instalación incorrecta;
- (b) incumplimiento de las instrucciones o precauciones de seguridad;
- (c) uso de piezas o accesorios no autorizados;
- (d) modificaciones o reparaciones no autorizadas;
- (e) accidentes, desastres naturales o causas externas.

Si tiene dudas sobre algún paso de la instalación o el funcionamiento, deje de usar el producto y póngase en contacto con el servicio técnico autorizado o con atención al cliente.

GARVEE
support@garvee.com