

CANMOV

Phone: 888-370-5534

E-mail: amazon.us1@zoy-living.com

Website : <https://canmov.myshopify.com>

<https://canmov.myshopify.com>

ATTENTIONS & Return Policy

1) After installation, in order to ensure that the chair can work normally, please follow the steps below to check:

- ① Check all the cables are connected correctly.
Check if the cables under the seat is loosed or not.
The red wire should be connected to the red one.
The white wire should be connected to the white one.
- ② Check if the light of the transformer is on.
- ③ Check if the light of remote is on.
- ④ Make sure the motor have a weak buzz (48 decibel) if the three above steps are normal.
- ⑤ Use some lubricant on the joints motor and mechanism of the chair.

2) If the chair does not work properly, please tell us your checking result. It is best to shoot video and send it to our e-mail, we can understand your problem faster and more accurately. Any questions or concerns, please contact us:

Phone: 888-370-5534

E-mail: amazon.us1@zoy-living.com

Website : <https://canmov.myshopify.com>

Our engineer will see where is wrong with the chair and provide you a satisfied solution. (If the parts were broken, we would like to send the replacement parts to you.)

3)Return Policy:

- ① please contact the customer service (888-370-5534) (provide the packing picture, we will handle the return process for you more quickly);
- ② please use the original carton to return the goods ensuring that the cartons are in good condition;
- ③ if the above two points are met, we accept the return, otherwise, our warehouse will reject the goods

<https://canmov.myshopify.com>

■ OUR BRAND STORY

Founded in 2001, CANMOV is a company specializing in living-room furniture. It researches, develops, manufactures and sells upholstered furniture with the aim to build a comfortable and eco-friendly environment.

Motion – our brand core conception, ergonomics and comfort, which is the most extraordinary beauty in the upholstered furniture. CANMOV devotes to provide high quality sofa enjoyment for millions in the world by its simplified American style design. We believe that design can always light up your life.

If you have any questions or concerns, please feel free to contact us,we will reply within 24 hours.

Phone: 888-370-5534

E-mail: amazon.us1@zoy-living.com

Website : <https://canmov.myshopify.com>

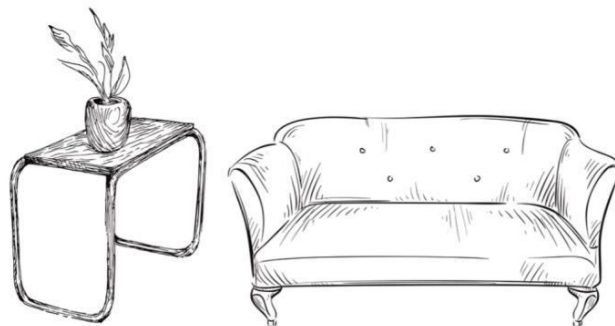

<https://canmov.myshopify.com>



CONTENS

P1. Attention & Return Policy

P2. Brand Story

P3. Contents

P4. Product Specifications

P5. Accessories & Installation guidance

P7. Usage Information

P8. Clean Tips

P9. Attention

<https://canmov.myshopify.com>

Recliner: The chair's dual-function operation allows you to recline and elevate your tired feet at once.

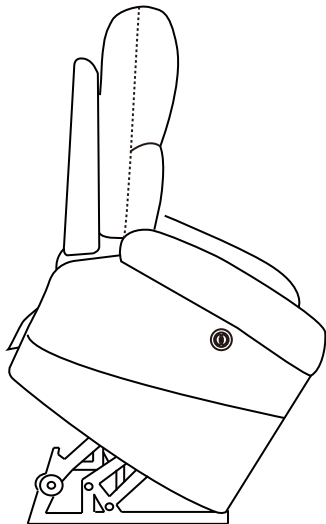
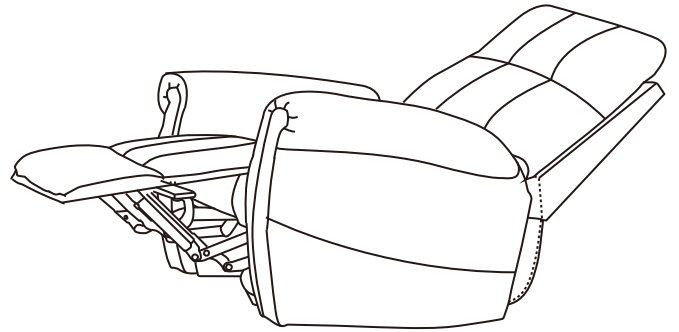

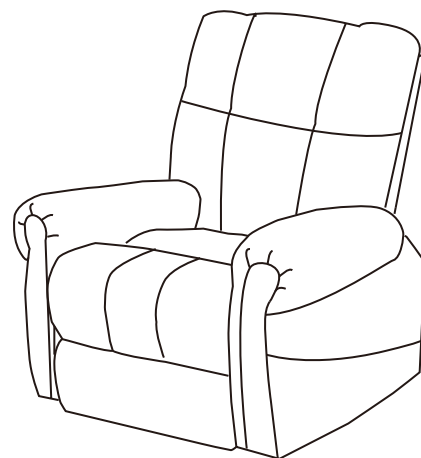

Durable mechanism: Rigorously testing 25000 times to ensure mechanical and building durability.

Deluxe Design: This recliner chair is the perfect companion for any media room or living room.

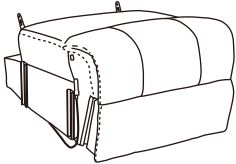

<https://canmov.myshopify.com>

FITTING LIST

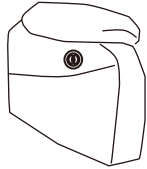
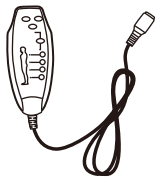
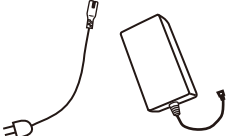
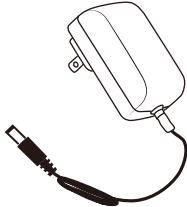
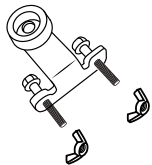
			
Chair seat	Backrest	Left armrest	Right armrest
			
Massage Remote	Power Source	Power Cord	2* Supporting Feet

ASSEMBLY INSTRUCTIONS

Step1: Find a small bag in the accessories box. Take out **Supporting Feet (H)**, from the small bag. Assemble the two Supporting Feet as shown on the bottom of mechanism to avoid toppling and falling.

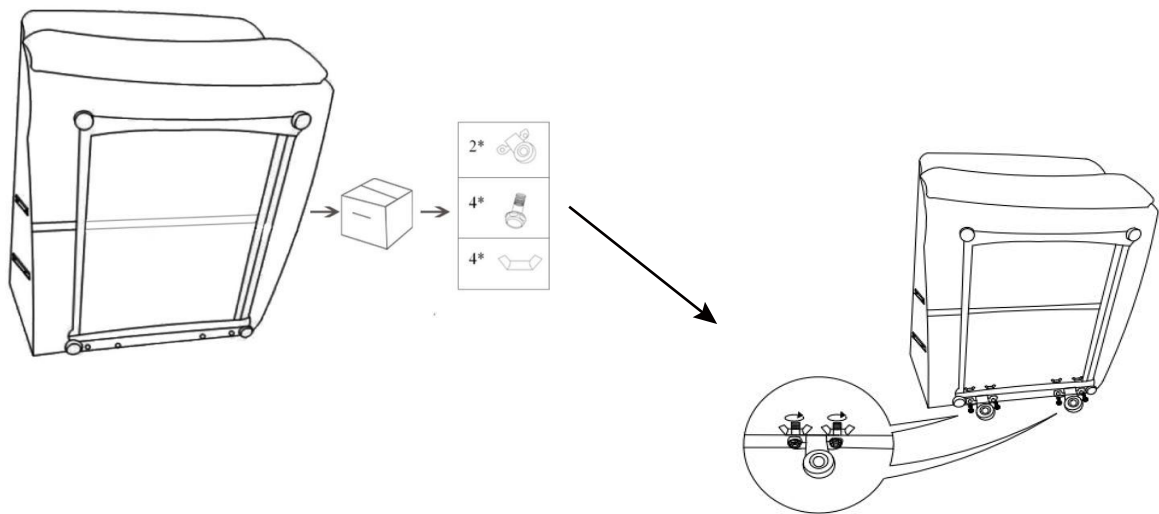

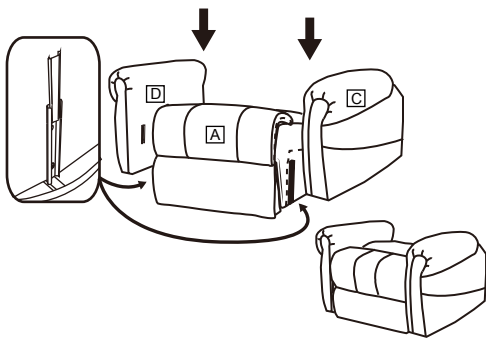

Step 2: Insert two armrests to the chair base, make sure the slots on the armrests fully assembled to the bottom part

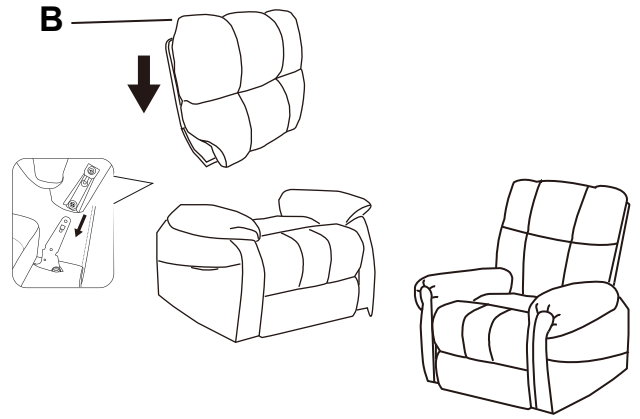

Step 3: Insert chair back to the chair base, make sure the slots on the back fully assembled to the bottom part.

No.1 and No.2 wire connect with the backrest and chair seat.

No.3 wire connects with backrest and power cord(G).

No.4 wire connects with backrest and massage remote(E).

No.5 wire connect the motor and the wire from rightside armrest which use to connect the control panel.

No.6 wire connect the motor and power source (F).

NOTE

1: Two same color wires connect.

2: Plug power cord(G) and power source(F) into outlet, then you can use all function.

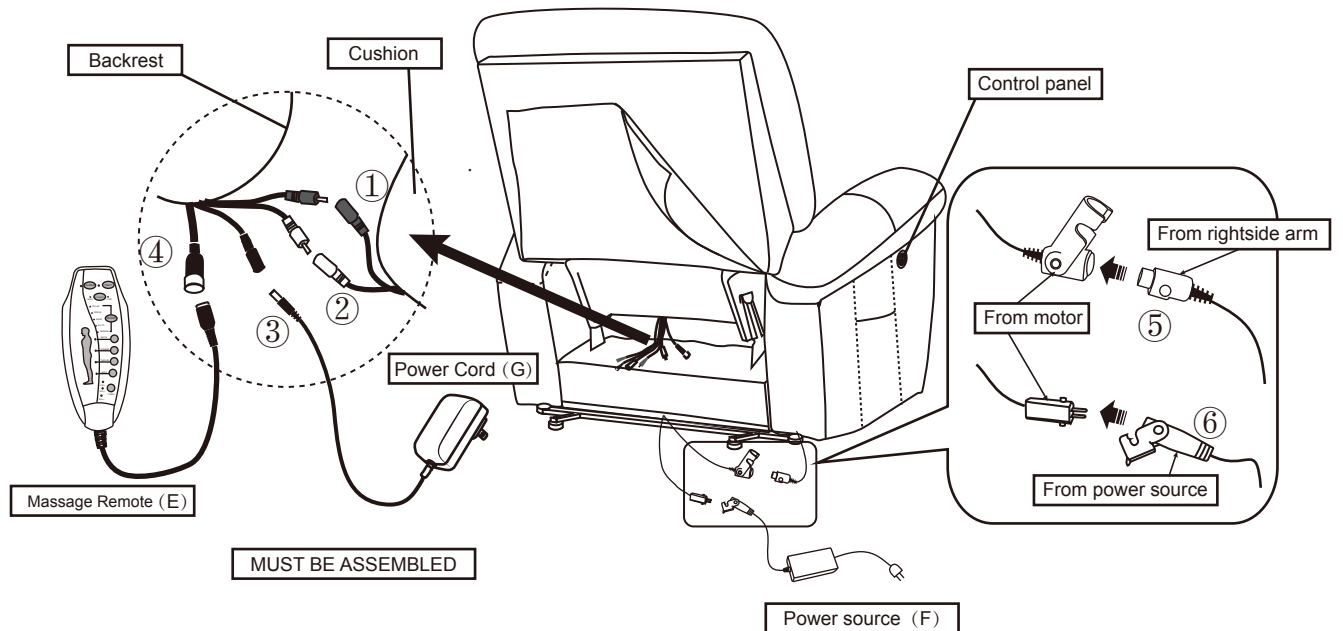

REMOTE OPERATION INSTRUCTIONS

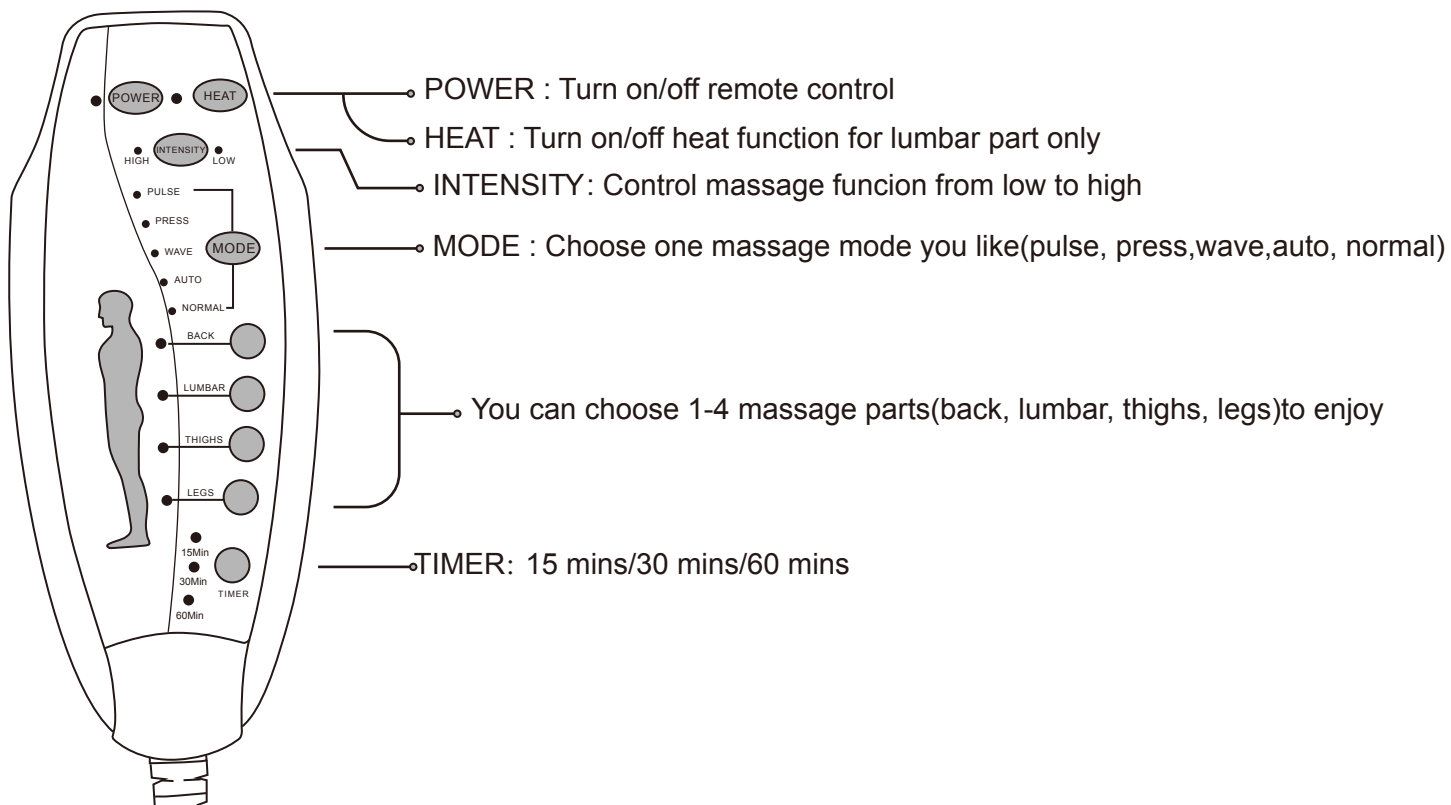

USAGE INFORMATIONS

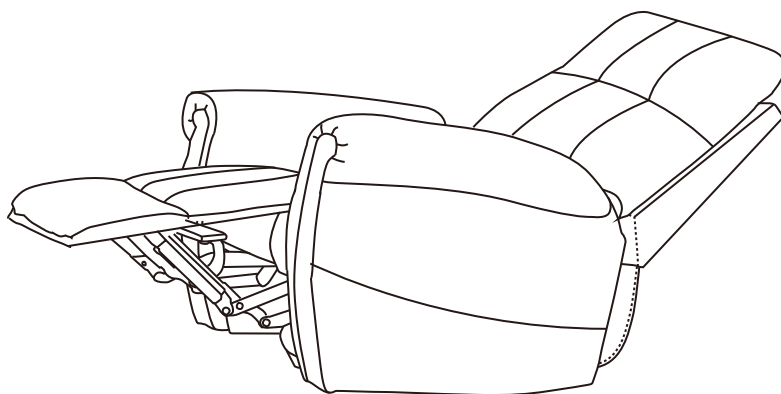
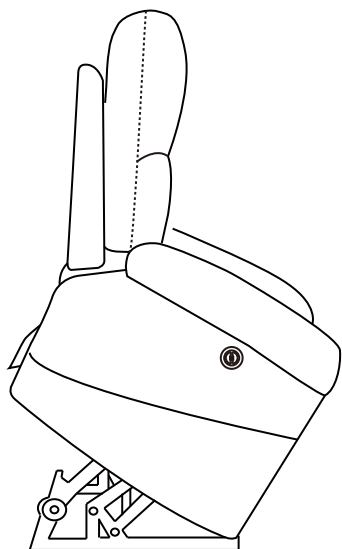

<https://canmov.myshopify.com>

■ TO STORE OR CLEAN

Maintenance Instructions

Rotate reversible cushions regularly.

Turn over & Rotate

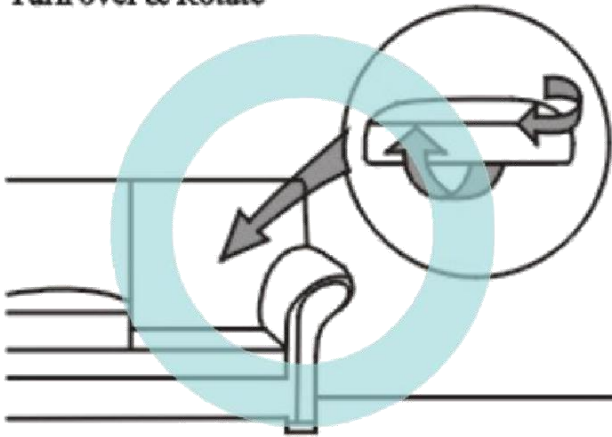

Vacuum your furniture regularly with upholstery tools



Do not expose your furniture to prolonged periods of direct sunlight.

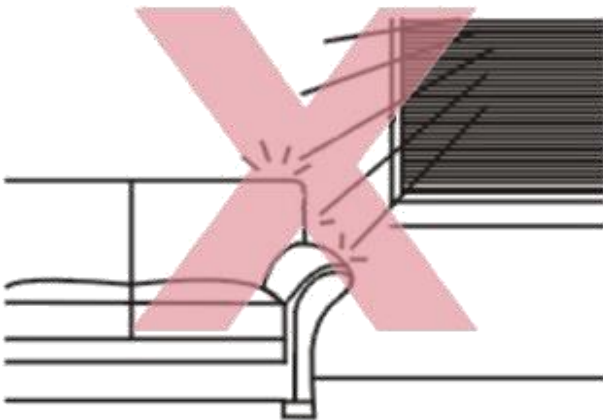

Do not place your furniture close to a radiator or similar heat source.

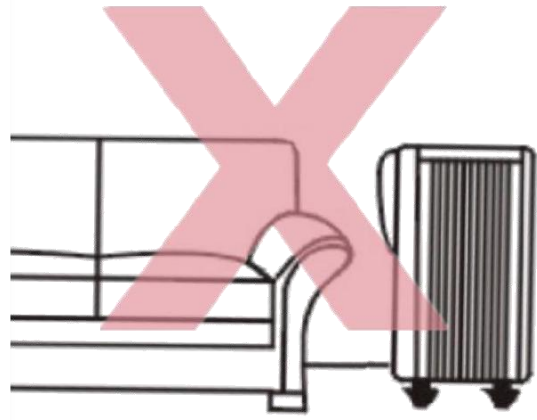

ATTENTIONS

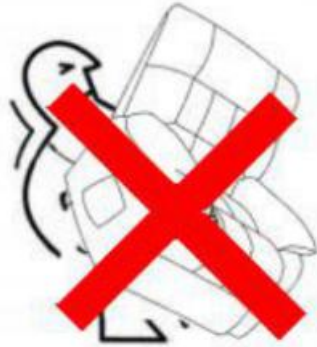

Moving the chair carefully to avoid falling armrests hurting your feet

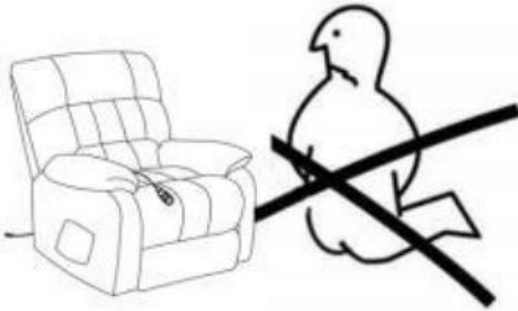
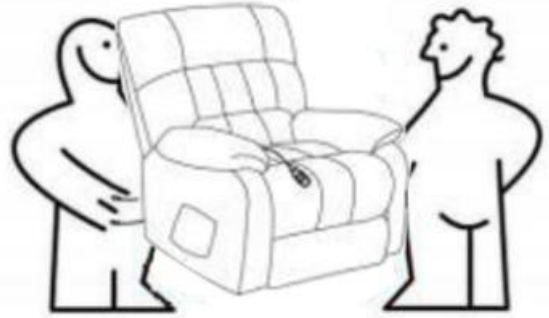

Put a carpet under the chair to protect your floor while assembling

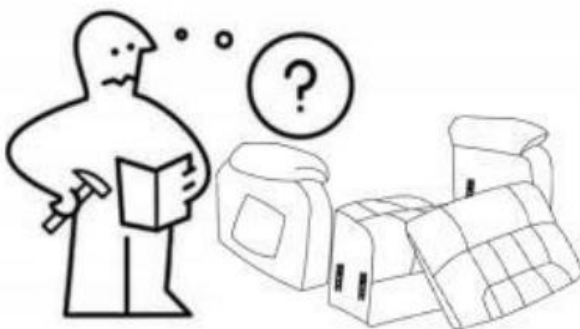
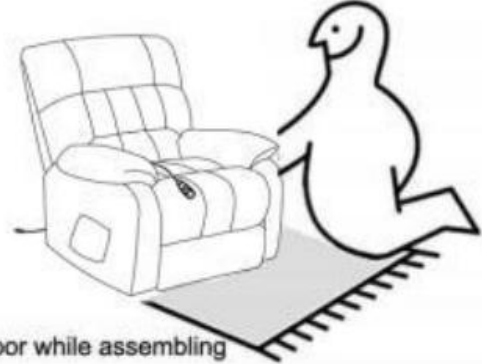

Website: <https://canmov.myshopify.com>

E-mail: amazon.us1@zoy-living.com

Phone: 888-370-5534

<https://canmov.myshopify.com>



All ▾

canmov



We believe that design can always light up your life.

If you have any questions or concerns, please feel free to contact us, we will reply within 24 hours.

Phone: 888-370-5534

Website: <https://canmov.myshopify.com>

E-mail: amazon.us1@zoy-living.com



CANMOV



<https://canmov.myshopify.com>