

## Smart Toilet (DV-1S0029-V1)

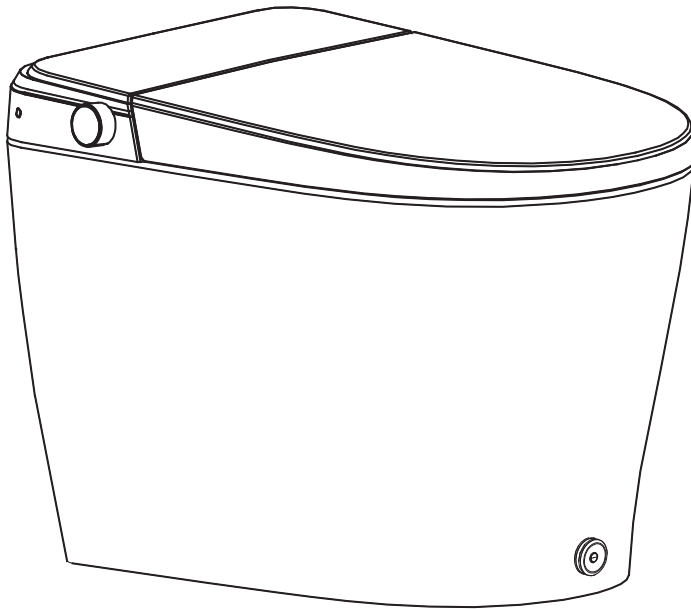

**NOTE:** Drawings may not exactly define contour of the product.



## Prior to Installation:

- Inspect toilet to ensure no damages have occurred while in shipping.
- Observe all plumbing and building codes in accordance with your state and local requirements.
- Remove old toilet.
- Make sure mounting surface is CLEAN and LEVEL.

### General Recommendations:

Please read installation and maintenance instructions thoroughly before installing the toilet.

Be sure to use proper tools and always wear proper personal safety accessories for your protection.

**If you have any questions or concerns  
please contact us:**

(+1) 312-626-9466  
[service@deervalleybath.com](mailto:service@deervalleybath.com)

# TABLE OF CONTENTS

---

● Important Safeguards .....	02
● Explanation of Terms and Symbols .....	03
● WARNING & Attention .....	04
● Product Installation .....	09
Tools needed .....	09
Parts included .....	09
● Parts Diagram .....	10
Smart Toilet overall view .....	10
Precautions before Installation .....	11
● Install the Smart Toilet .....	12
● Knob and Other Operation .....	15
● Battery Backup Installation .....	17
● Specifications .....	18

---

## 1. Important Safeguards

### IMPORTANT SAFEGUARDS

When using electrical products, especially when children are present, basic safety precautions should always be followed, including the following:

### GROUNDING INSTRUCTIONS

This product must be grounded. In the event of an electrical short circuit, a grounded product reduces the risk of electric shock. This product is equipped with a cord having a grounded wire with a grounded plug. The plug must be plugged into an GFCI outlet that is properly installed and grounded.

**DANGER** – Improper use of the plug can result in a risk of electric shock.

Check with a licensed electrician or serviceman if the grounding instructions are not completely understood. Or if there is any doubt the product is properly grounded. This product is for use on a nominal 110 V circuit, and has a grounded plug that looks like the electrical plug illustrated below.

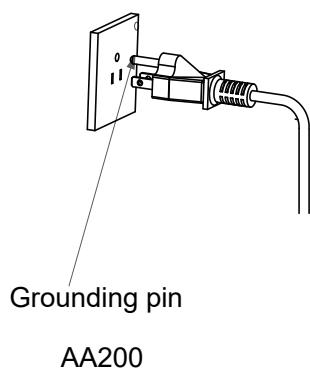

### Grounding Methods

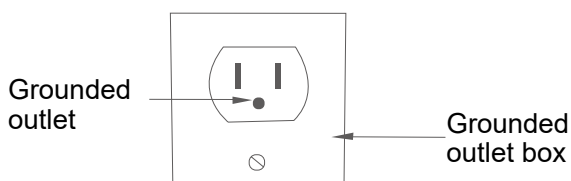

**\*WARNING:** Risk of electric shock. Connect the unit only to a circuit protected by a ground-fault circuit-interrupter (GFCI).

NOTE: Installation of the DeerValley Smart Toilet may require specialized tools. Plumbing components are not included.



## 2. Explanation of Terms and Symbols

Thank you for purchasing our product. Please read this User Manual before installation and use and save it for future reference. The hazards and warnings listed herein are important to our users' safety. Significant consequences may result from failure to heed warnings.

### Explanation of Terms and Symbols

**WARNING** . . . Indicates possible injury or death resulting from improper usage due to disregarding this message.

**ATTENTION** . . . Indicates human injury or property loss that may result from improper usage due to disregarding this message.



. . . . When used with the above "Warning" and "Attention" signs, indicates a strict request to follow noted precautions.



. . . . Prohibits any individual from performing any action with this symbol.



. . . . Prohibits any individual from disassembling the product.



. . . . Keep product away from any wet environments, including, but is not limited to, humid environments, close proximities to baths, showers or sinks.



. . . . Do not touch.



. . . . Do not touch with a wet hand.



. . . . Keep away from any extreme heat or fire.



. . . . Operate only as instructed.



. . . . Unplug the unit from power.



. . . . Protective grounding.

**NOTE:** Drawings may not exactly define contour of the product.

## **WARNING**

This product needs to be properly grounded.  
**Risk of electric shock. If unsure, contact an electrician.**



Do not place a lit cigarette along with other burning objects into the unit.  
**Risk of fire.**



Do not touch, insert or pull out the power plug with a wet hand.  
**Risk of electric shock.**



Do not use during thunderstorms (pull out the power plug during storms).  
**Failure in doing so may lead to injury or malfunction.**



Do not use a power socket in poor condition or a damaged power plug.  
**Risk of fire and/or electric shock.**



When the seat or lid is damaged, to avoid any harm, be sure to unplug the unit from power, shut off the water supply and contact your local distributor for replacement.  
**Risk of fire and/or electric shock.**



The power socket in use should be within the specified range  
(AC 110 V  $\pm$  10%, Max current > 10A).  
**Risk of fire and/or electric shock.**



**NOTE:** Drawings may not exactly define contour of the product.

 **WARNING**

Regularly unplug the unit from power and wipe off any dust on the plug using a dry cloth.

**Risk of fire.**



Young children, the aged and the physically disabled should be given supervision by a person responsible for their safety while using the unit.

**Otherwise, prolonged use may cause low temperature burns.**



Do not pull, damage, bend, twist, stretch, roll, bundle, clamp or squeeze the power cable. Do not place anything on power cable.

**Risk of fire and/or electric shock.**

This product is not a toy. Advise children not to play with product.

**Risk of injury.**



If the power cord is damaged, to prevent any injuries or accidents, it should be replaced by a professional.

**Risk of fire and/or electric shock.**



For cleaning or maintenance of plastic parts, do not use any harsh cleaning agents. (These include but not limited to concentrated sulfuric acid, concentrated nitric acid, glacial acetic acid, carbon tetrachloride, chloroform, acetone, butanone, benzene, methylbenzene, phenol, methylphenol, dimethylformamide, methyl ether, soybean oil, acetate, 40% nitric acid, thick salt acid, 95% alcohol, kerosene, gasoline, or brake oil, etc.)

**Otherwise, the plastic part may crack and cause personal injury;**

**Risk of fire and / or electric shock.**

**NOTE:** Drawings may not exactly define contour of the product.

## **WARNING**

Do not disassemble, repair or alter this product on your own. Call in a professional or contact service center for future advise.

**Risk of fire, electric shock, and/or other accident that may lead to injury.**



Do not use industrial or polluted water.

**Risk of cystitis, dermatitis and electric shock and fire due to internal corrosion of the unit.**



Do not apply any force to the unit's seat and lid. Do not stand on the lid or open or close the lid and the seat forcefully.

**Risk of product damage and user injury.**



Do not add water or detergent into the unit or onto the remote control. Do not splash water or cleaner on the product and power plug.

**Risk of fire and electric shock.**



Avoid direct sunlight or heat.

**Risk of product discoloration.**



Do not install or use the unit in a damp and easily immersed bathroom. Do not spray water on this product or rinse it with water to prevent damage.

**Risk of fire and electric shock.**



While using the unit, make sure that the skin is in contact with the seat sensor area. Otherwise, product may not operate correctly.

**Children may have difficulty staying in contact with sensor area.**



**NOTE:** Drawings may not exactly define contour of the product.

 **ATTENTION**

To avoid danger from false reset of the thermal breaker, do not supply power through an external switching device, such as a timer, or connect to a circuit that is periodically turned on and off by a general-purpose component.



To prevent damage and water leakage, avoid striking the ceramic with force.



Do not use the heated seat for a long time with high or middle temperature.

**Risk of burns.**



Please do not bury cementitious materials (cement mortar, etc.) in the toilet base to prevent the toilet from being cracked due to expansion.



Do not flush newspaper, diaper pads, sanitary napkins and other items that are easily blocked into the toilet.



In case of sudden power failure, unplug the power plug and turn off the angle valve to prevent water leakage.

**Risk of water leakage or property loss.**



Do not use the unit in an environment below 0°C.



**NOTE:** Drawings may not exactly define contour of the product.

 **ATTENTION**

When the product is not in use for an extended period, unplug the unit. Ensure to turn off the water supply and drain any remaining water inside the product for optimal storage.

**Risk of fire, leakage and product damage.**



Do not use an old hose to connect to the unit. Utilize the hose provided with your product. Any other connections to the older hose may require replacement.

**Risk of water leakage and property loss.**



When storing or transporting in cold climate, make sure to drain the water from the unit. Product may crack and other damages may occur due to freezing water.

**Risk of fire, leakage, and product damage.**

**WARNING– To reduce the risk of burns, electrocution, fire, or injury;**

1. Close supervision is necessary when this product is used by, on, or near children.
2. Use this product only for its intended use as described in this manual. Do not use attachments not recommended by the manufacturer.
3. Never operate this product if it has a damaged cord or plug, if it is not working properly, if it has been dropped or damaged, or dropped into water.

**Return the product to a service center for examination and repair.**

1. Keep the power cord away from heated surfaces.
2. Never use while sleeping or drowsy.
3. Never drop or insert any object into any opening or hose.
4. Do not use outdoors or operate where aerosol (spray) products are being used or where oxygen is being administered.
5. Connect this product to a properly grounded outlet only. See Grounding Instructions.

**NOTE:** Drawings may not exactly define contour of the product.

## 1. Product Installation

### (1) Tools needed



Drill (with 6mm Bit)



Raw Tape

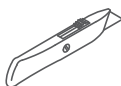

Utility Knife



Marker



23-26mm (Adjustable Wrench)

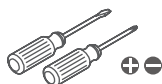

Screwdriver



Tape Measure



Measuring Cup

### (2) Parts included

Smart Toilet



Connector

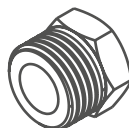

Wax Ring



Floor Bolts



Operating Instruction  
and Other Prints

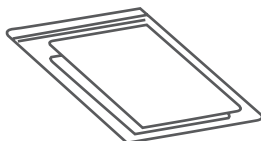

Please verify that all items in the package are present. In case of any missing parts, kindly reach out to our customer service department at (+1) 312-626-9466. The image is for reference purposes only; please consult the actual product for accurate details.

**NOTE:** Drawings may not exactly define contour of the product.

## 2. Parts Diagram

### (1) Smart toilet overall view

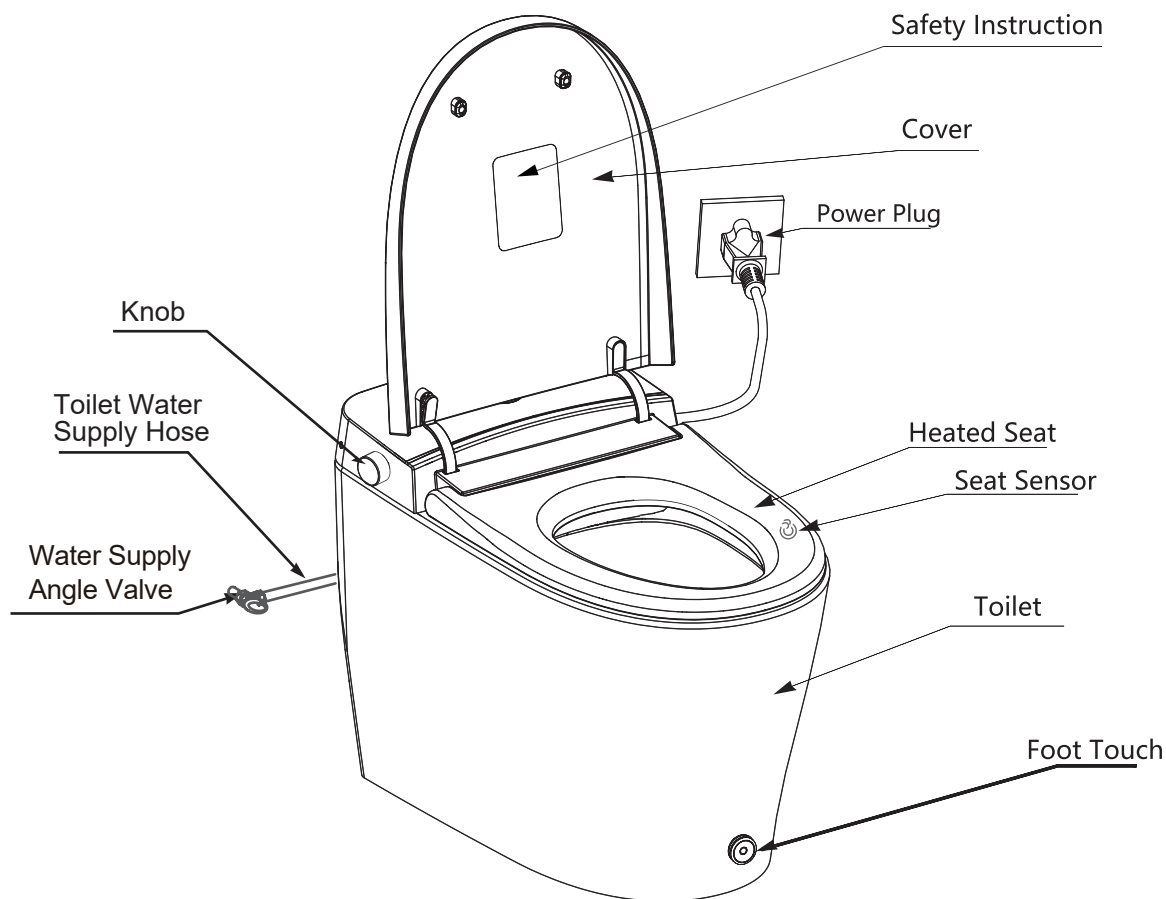

#### Knob

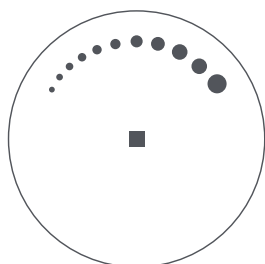

● Actual product features and appearance prevail over depictions and descriptions.

**NOTE:** Drawings may not exactly define contour of the product.



## (2) Precautions before Installation

### Confirmation of water pressure

- The minimum dynamic operating water pressure is 25 Psi, and the maximum static water pressure is 80 Psi.

#### Determination method for minimum water flow

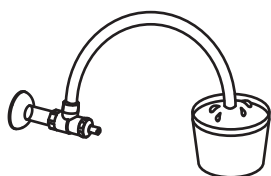

(Tools: stopwatch, measuring cup.)

Open the angle valve for water supply. The measured water flow for 10 seconds should exceed 3L.  
 ※If the above conditions cannot be met, the best flushing effect cannot be achieved and an additional booster pump is required to increase the pressure.

### Confirm dimensions of product with installation space

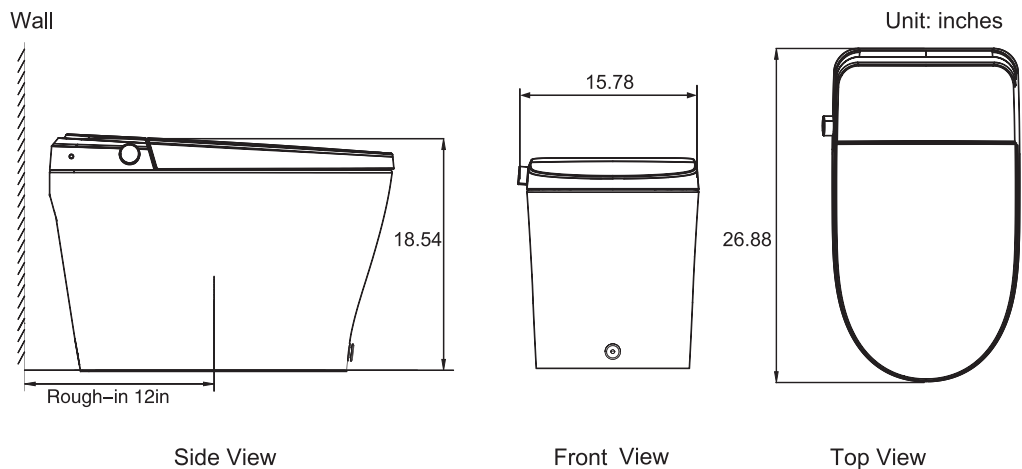

**NOTE:** Drawings may not exactly define contour of the product.

## 4. Install the Smart Toilet

- (1) Draw a cross marker on the drain outlet on the ground.
  - Clean the floor and wipe off any excess dust or dirt. Failure to install on a cleaned surface will affect the quality of installation.

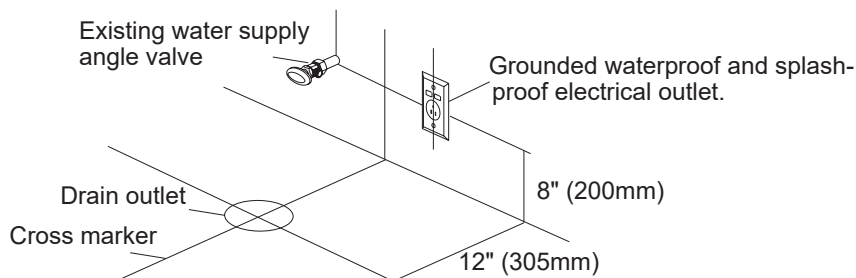

- (2) Installation of floor flange.

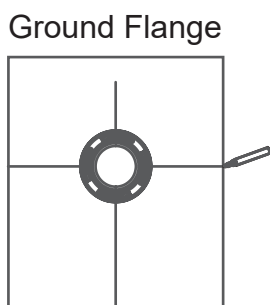

- (3) Install smart toilet bottom flange anchor screw.

- Turn the ceramic body over laterally and place on a prepared foam surface. By visual measurement, draw a line on one lateral side of the ceramic body point of the drain outlet perpendicular to the plane against the central of ceramic bottom, and the same for the other lateral side, and draw a line perpendicular to the floor from the front central point of ceramic body.

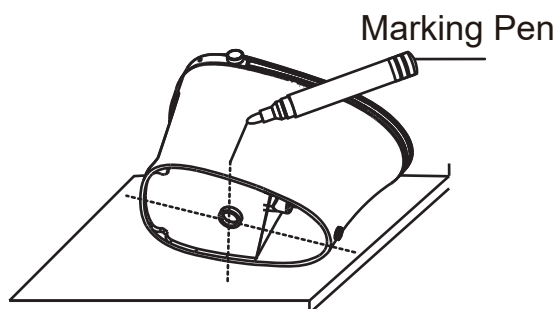

**NOTE:** Drawings may not exactly define contour of the product.

(4) Install the wax ring and brass floor bolts onto floor flange.

- Insert the 2 brass floor bolts flat head thru the appropriate slot in the floor flange. Use the provided plastic floor bolt washer to secure the floor bolts on the floor flange. Brass bolts should remain vertical FIGURE 5A. Install the wax ring at the sewage outlet of the product FIGURE 5B.

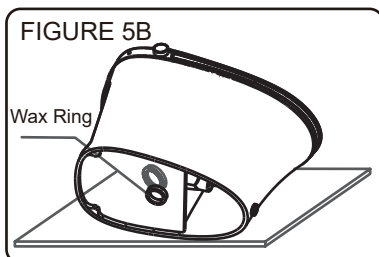
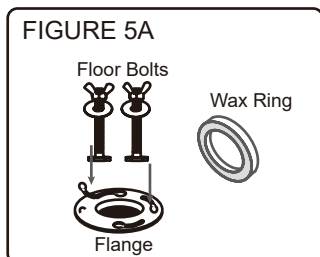

(5) Preparing the toilet seat for toilet bowl installation.

- Hold both seat and cover vertical, pull upward to detach them from ceramic bowl. Move the seat forward as shown.

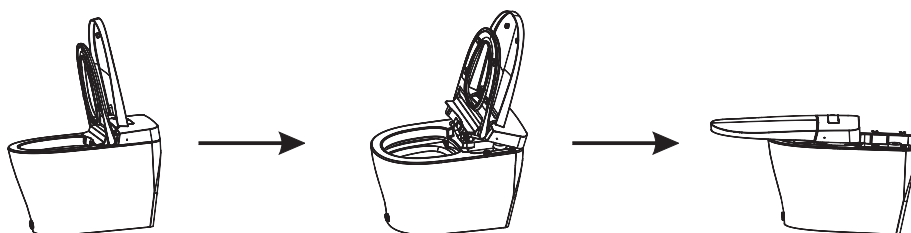

(6) Installing the toilet bowl onto floor flange

- Lift the toilet bowl with two people and gently lower it onto the floor flange, aligning it with the guide markings as the reference. Ensure that the floor bolts completely protrude through the bolt openings on the bottom of the toilet bowl when viewed from behind the seat.
- Press down firmly on the toilet bowl to allow the wax ring to create a complete seal.
- Hand-tighten the nuts onto the floor bolts from the opening behind the back of the seat to securely fasten the toilet bowl to the floor.

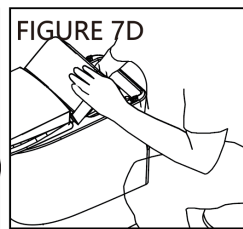
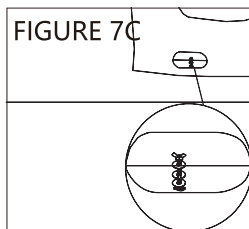
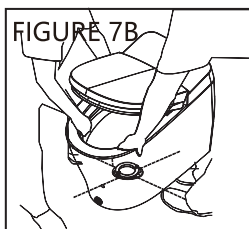
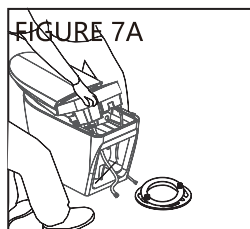

**Caution:** Do not move the toilet bowl around once the toilet bowl is in position. It can damage the wax ring seal and result in water leakage.

**NOTE:** Drawings may not exactly define contour of the product.

## (7) Connecting braided water supply hoses.

- With the 3/8" male connection facing to the right, apply Teflon tape and screw on adapter (supplied).

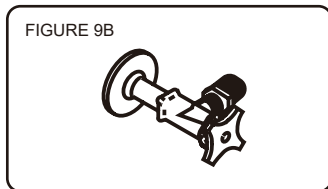
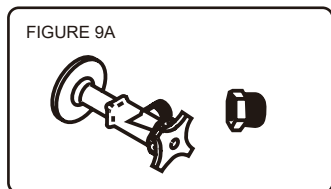

- Connect toilet water supply hose to male thread on adapter (apply Teflon tape to male threads). Connect braided supply tubes to valve male connections.
- Note: Use Teflon Tape on all threaded connections to ensure a water tight seal.

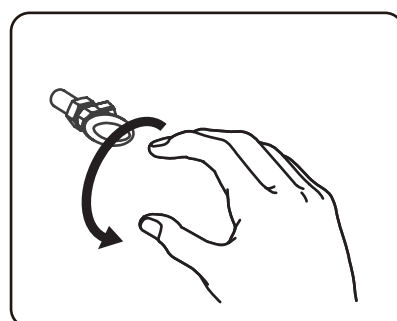
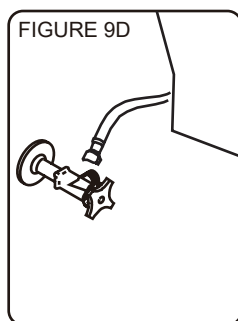
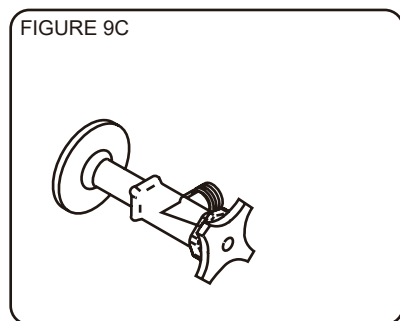

## (8) Confirm the water supply.

- Open the water supply angle valve to the greatest extent as shown in the drawing.
- Make sure there is no water leakage in each connection part. If there is water leakage, please re-tighten the nut for re-installation.

## (9) Connect the power supply.

- Connect the ground wire.
- Power plug into the AC 120V socket.
- Confirm whether the power is connected.

### Note:

Confirm indicator light on the power plug. A lit-up power indicator light will confirm that the smart toilet is powered-on.

When powered on, press and hold the knob for 3 seconds to enter standby mode.

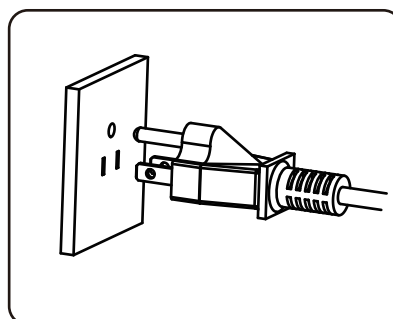

**NOTE:** Drawings may not exactly define contour of the product.

## Knob and other operation

### ■ Night Light

To toggle the night light on/off, press and hold the knob, then turn it 45° forward.

### ■ Power Saving (ECO) Mode

While seated, activate/deactivate the ECO power-saving function by pressing and holding the knob, then turning it back 45°.

### ■ Seat Temperature Control

Power on and vacate the seat.

Adjust seat temperature by turning the knob forward above 45° to increase and backward above 45° to decrease.

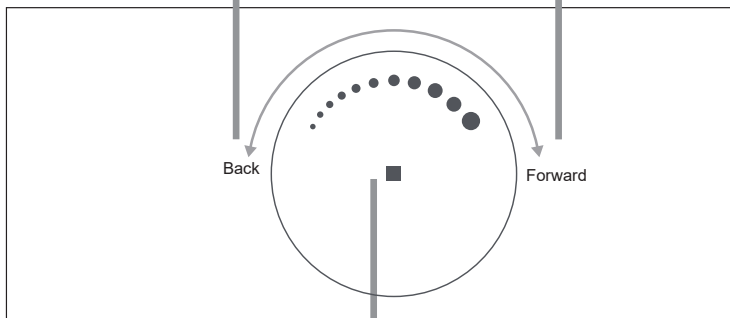

### ■ Power/Flush

**In standby mode:** Long press the knob for 3 seconds to power on.  
**Power on and away from the seat:** Long press the knob for 3 seconds to enter standby mode.  
**While seated and the unit is on:** Long press the knob for 3 seconds to open/close the automatic flushing function. Short press the knob to flush the toilet once.

### ■ Factory Data Reset

Power on and vacate the seat.  
 Restore factory settings by pressing and holding the knob, then turning it back 45°.

**NOTE:** Drawings may not exactly define contour of the product.

## ■ Deodorization

The function will operate automatically.

Deodorizing fan automatically turns on after seating and turns off 3 minutes after leaving the seat.

## ■ Auto Flush

Human body leaves the seat sensor area after seating.

When the human body leaves the seat after seating, it will automatically flush once.

## ■ Kick to Flush

Kick the "foot touch button".

Gently kick the button to flush the toilet.  
Avoid kicking with excessive force or at a high frequency.

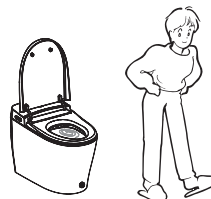
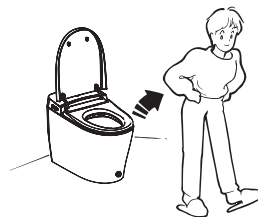

**NOTE:** Drawings may not exactly define contour of the product.

## Battery Backup Installation

●Lift the toilet lid from the bottom, unscrew the battery cover with a Phillips screwdriver, insert a 9V battery, cover the battery compartment, and tighten it with a screwdriver. Place the toilet cover flat on the seat and press down to secure it. After installing the battery, press the side button to activate the power failure flushing function.

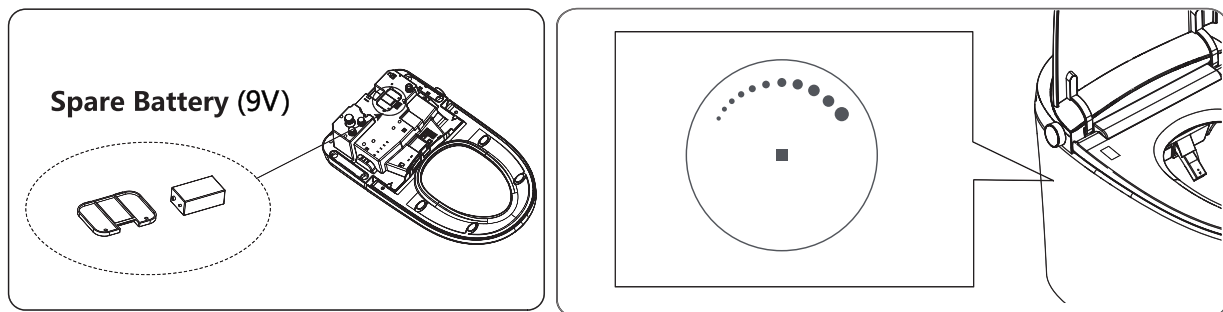

### Attention:

Please ensure the correct installation of the battery by confirming the positive and negative terminals. Exercise caution by avoiding charging, disassembling, burning, or mixing batteries with old or different types to prevent potential leakage or explosions. The battery box is equipped with moisture-proof features, so it is crucial to securely tighten the fixing screws for effective sealing. In the event of battery replacement, it is recommended to seek assistance from professionals to ensure a safe and proper replacement process.

### User-Friendly Design

#### ● Slow-Closing Lid/Seat

Preserves your toilet's life and allows you to close the lid/seat silently.

#### ● Damper

The product has installed a damper that provides the toilet cover and seat with a buffer function to achieve the mute effect.

#### ● Memory Mode

After a power failure, water temperature, water pressure, seat temperature, and wand position are all restored to mid-range. The night light is turned on by default after a power failure. The on/off setting keeps the last memorized state.

#### ● Pre-flushing

After seating, the product will flush once towards the seat to ensure that the toilet wall is moistened.

**NOTE:** Drawings may not exactly define contour of the product.

## 9. Specifications

### (1) Product specifications

Power rating		110V
Frequency		60Hz
Rated power input		49W
Seat temperature range		39.4 °F~104 °F
Source water temperature range		39.4 °F~95 °F
Water supply type		DN15 (G1/2")
Water Inlet	Minimum pressure	25psi, ensuring a flow of water at least 18L/min
	Maximum pressure	80psi (still)
Toilet	Flush type	Tornado flush
	Rough-in	Rough-in 12in
Seat ring	Seat ring temp	Off/about 93.2 °F~104°F (4 levels)
	Safety devices	Thermal fuse
Power cable length		Appx. 59in
Product dimension		26.88in * 15.78in * 18.54in

### (2) Function Table

Category	Function	
Comfort	Seat heating	•
	Seat ring temperature adjustment	•
	Air-cleaning filter system	•
	Soft close seat cover	•
	Electrostatic induction	•
Human care	Night Light	•
	Foot touch control flush	•
	Automatic flush	•
	Flush with power failure	•
	Antibacterial nozzle & seat cover	•
	Pre-wetting	•
Safety	Business mode	•
	Nano glaze	•
	Self diagnosis	•
	Prevent low temperature scald	•

**NOTE:** Drawings may not exactly define contour of the product.



### (3) Regular maintenance

Regular maintenance is required to ensure normal use

#### **WARNING**

Do not spray water or detergents on the toilet, or the power cord. Doing so may cause electric shock or fire.

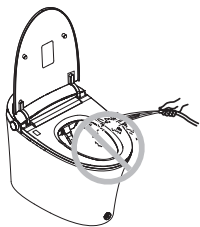

#### **Note**

- Cut off the power and water supply before maintenance.
- Direct water wash to the entire product is prohibited.

■ During winter season, the water inside may freeze after long periods of storage and non-usage. Please take measures to prevent.

#### **Note**

- Before connecting the product to the water supply and electrical outlet, allow it to defrost for 30 mins in a warm indoor environment.
- In cases of extreme cold/freezing/nozzle stuck in place, wrap the water input line with a warm towel. Never pour hot water or use a hot dryer directly on the toilet.

#### Maintenance of product surface and ceramics

- Wipe dust or stains with a soft wet cloth
  - A wet soft brush, cloth or sponge may be used to clean the ceramic area
- Do not use abrasive cleaning solutions, such as alcohol, bleach, paint thinner, cresol, benzene, gasoline, etc.

**NOTE:** Drawings may not exactly define contour of the product.

## (4) Problems & Solutions

### Power Button

Problems	Fault Diagnoses	Solutions
Not working	Check whether the attaching plug is loose or not	Please check the circuit
	Check whether the power is switching on or off (the power light is not on)	Press rotated switch for 3s, the power light is on.
	Check whether there is any electric leakage or not (the light of leakage protection plug is not on)	Unplug the attaching plug from the socket, plug it again later. Press the reset switch of the leakage protection plug, if it is still not working, please unplug the attaching plug and contact with local distributor to repair.

### Heated Seat

Problems	Fault Diagnoses	Solutions
The seat temp is too low or is not hot	Check whether the temp of toilet seat is on the "off" position or not	Regulate the temperature of toilet seat according to the instruction manual

### Toilet Unit

Problems	Fault Diagnoses	Solutions
Inadequate flushing of the product	No power supply	Power restoration
	No water from the spout	Please contact with our qualified maintenance personnel for repairing
	No water flow, but flushing sound is heard	1. Verify if the pipeline is obstructed. Ensure the water supply pipeline is unobstructed and flowing smoothly. 2. Inspect the water pump for any damage or malfunction.
	Continuous Water Flow	Please contact certified maintenance personnel to address any issues with the water inlet valve and ensure proper product flushing.

### Soft-Closing Feature

Problems	Fault Diagnoses	Solutions
Seat cover/ring cannot be flipped up or down	Damaged damping mechanism	1. Try unplugging the attaching plug, then recharge and test again. 2. If the issue persists, please seek assistance from qualified personnel for further troubleshooting and repair.

**NOTE:** Drawings may not exactly define contour of the product.

## LIMITED WARRANTY COVERAGE

### 1 YEAR LIMITED WARRANTY

DeerValley products are made with quality materials and excellent craftsmanship to provide the customers a long-lasting product. In the case of any defects in materials or craftsmanship under regular use were inspected in the first one year of delivery, DeerValley will provide replacement parts at no charge, or at its option, replace any product or part of the product that is deemed defective, under normal installation, use, service and maintenance. This warranty applies only to the original purchaser. Proof of purchase will be required in the case of a claim. **SCRATCHES ARE NOT COVERED UNDER WARRANTY.**

The manufacturer warrants this product to be free of manufacture defects during the above mentioned warranty time. Please keep a copy of the original invoice as proof of purchase.

DeerValley will, as its option, (1) repair or replace the defective part(s) or product(s) at no charge; (2) issue a refund of the original purchase price of the product(s) (Valid within 30 days from the date of delivery); or (3) issue a credit to be applied toward the purchase of a new DeerValley product shipping/delivery charges may apply and are in DeerValley sole discretion.

DeerValley recommends the installations to be made by a licensed, professional plumber. DeerValley will not be held responsible for any damage or product failure due to improper installation, misuse, or failure to use a licensed professional. DeerValley is not responsible for any removal or installation cost.

This limited warranty shall not apply to goods which have been subject to accident, negligence, improper installation, product abuse, product misuse, or use of cleaners containing abrasives, alcohol or other organic solvents, whether performed by a contractor, service company, or yourself, are excluded from this warranty.

DeerValley responsibility under this limited warranty is limited to only to replacement parts and no other costs. DeerValley will not be responsible for labor charges and/or damage incurred by installation, repair or replacement, nor for any indirect incidental or consequential damages, losses, injury or costs of any nature relating to this product Except as provided by law, this limited warranty is in lieu of and excludes all other warranties, conditions, and guarantees, whether expressed or implied, statutory or otherwise, including without restriction those merchantability of fitness for use.

### RESPONSIBILITIES OF OTHERS

Inspecting the unit prior to installation is the responsibility of the installer or building contractor who acts on behalf of the user. They are responsible for ensuring the unit is free of defect or damage.

Notices are placed on and in the unit and on the shipping carton advising the installer of this responsibility.

In the event of a problem, the unit must not be installed. DeerValley is not responsible for failures or damage that could have been discovered, repaired, or avoided by proper inspection and testing prior to installation.

Damage occurring in transit is the responsibility of the carrier. The user or installer **MUST** open the crate and inspect the unit for damage when it is delivered. If damage is discovered, it must be reported immediately to the seller and the carrier in writing, and an inspection requested. Failure of the carrier to respond should be reported to the seller and the carrier. Your freight claims should be filed promptly thereafter.

### LIMITATIONS AND EXCLUSIONS

This warranty does not cover instances of negligence, misuse, abuse, improper installation, carelessness, accident, hard water or mineral deposits, exposure to corrosive materials, misapplication, damages caused by improper maintenance, alteration of the product, or failure to follow care or installation instructions enclosed with your product. This warranty is void if the DeerValley is subject to alteration, or if repairs are attempted by anyone other than an authorized agent of DeerValley. This warranty does not extend to plumbing or components installed by dealers, installers or by any party other DeerValley.

DeerValley will not be liable for loss of use of the DeerValley inconvenience, or any other incidental or consequential costs, expense or damages. Please note that some states do not allow the exclusion or limitation of incidental damages.

### DISCLAIMER

Except as expressly provided, there shall be no warranty or obligation, express or implied, oral or statutory. No dealer or other person has the authority to make any warranties or representations concerning DeerValley or its products. In no event shall DeerValley be held responsible for any such warranties or representations.

### WARRANTY SERVICE

NOTE: When requesting warranty, be sure to have the following:

- Copy of original invoice
- Date of installation
- Description and pictures of defect
- Model number or description of model

To obtain warranty service and replacement part, please contact DeerValley Customer Service. DeerValley will determine whether to repair or replace your product, issue a refund, or issue a credit.