

# ASSEMBLY INSTRUCTION

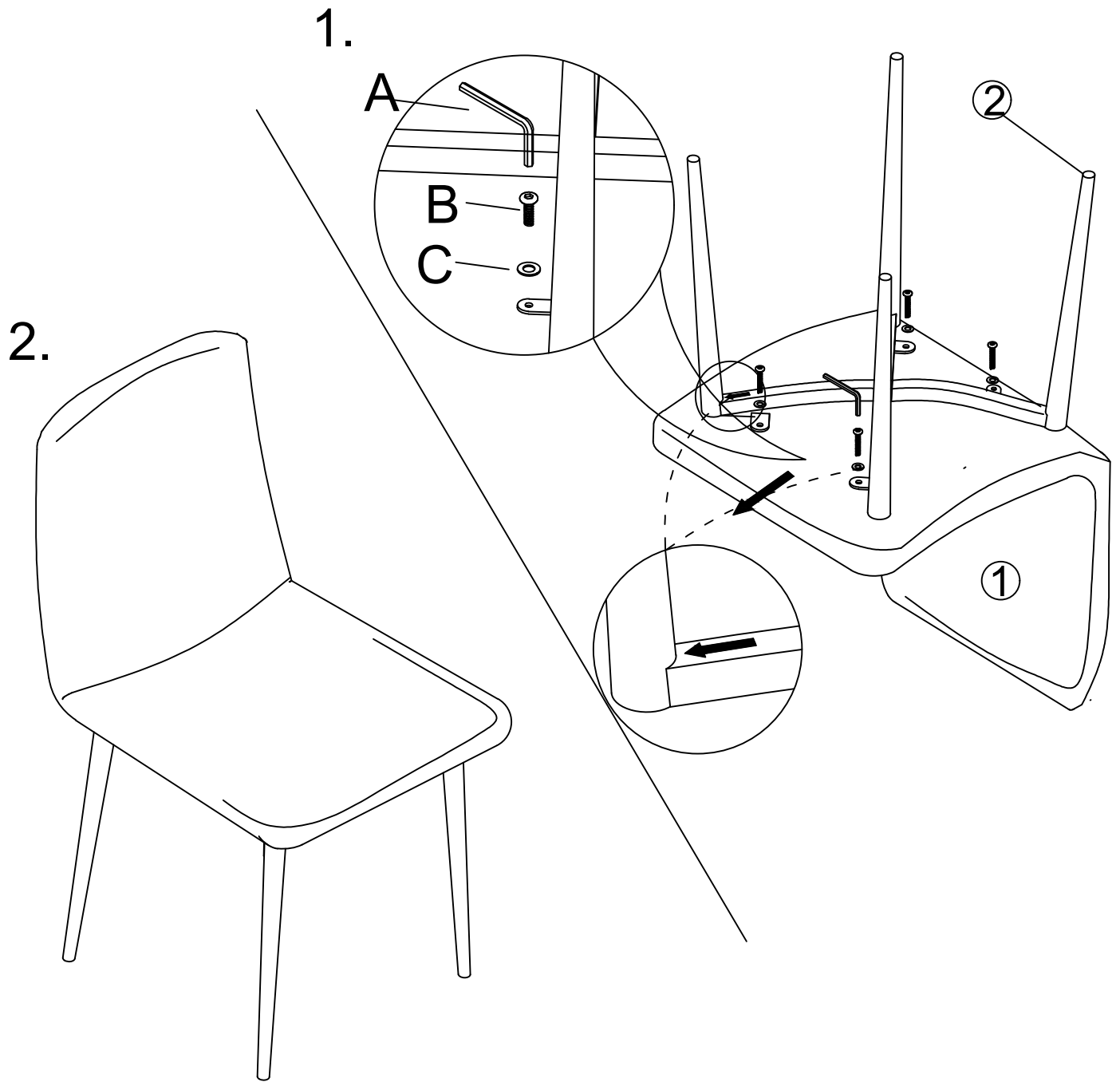

①



X1

②

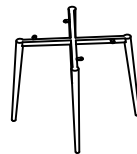

X1

A

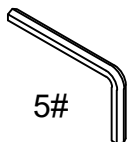

5#

X1

B

M6X16



X4

C



M6

X4



!WOODEN MATERIALS ! NO ELECTRIC DRILL!

# ASSEMBLY INSTRUCTION

1.

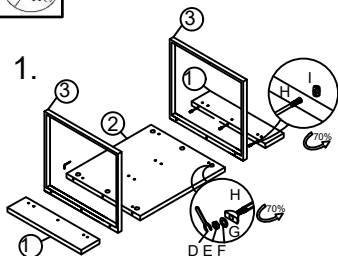

70% do not need to be tightened

2.

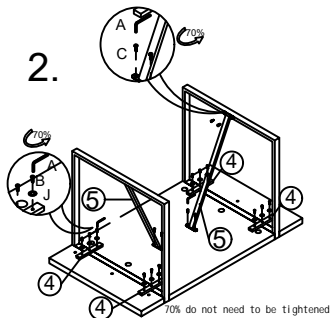

70% do not need to be tightened



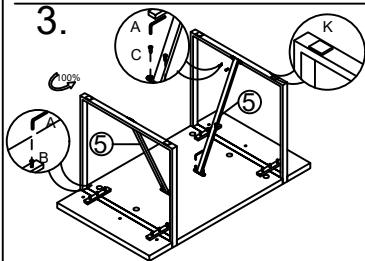





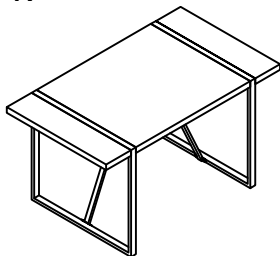







3.



100% fully tightened

4.



 X2	 X1	 X2	 X4	 X2	
 5# X1	 M6X40 X12	 M6X18 X8	 X1	 M8 X6	
 M8 X6	 M8 X6	 M8x140 X6	 M8 X6	 M6*22 X12	 X4