



User Manual

SMART TOILET

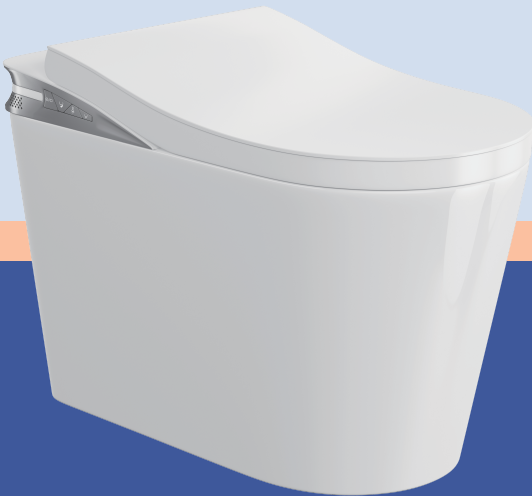

Table Of Contents



Safeguards & Precautions	01
Getting Started	03
Specifications	03
Features	05
Operations	07
Remote Control	07
Control Buttons	09
Installation	12
Maintenance	13
Troubleshooting	14
Frequently Asked Questions	18
Contact Us	19

Safeguards & Precautions



When using electrical products, especially when children or invalids are present, basic safety precautions should always be followed, including the following:

DANGER

Risk of Electric Shock

- This appliance **MUST** be grounded. Connect only to a circuit protected by a Ground-Fault Circuit-Interrupter(GFCI) or Residual Current Device(RCD).
- Do not install or store this appliance where it will be exposed to the weather or temperature below freezing.
- Use this appliance only for its intended purpose.
- Disconnect the power before servicing.

WARNING

Risk of Personal Injury

- Set the heated seat temperature to low or off to prevent low-temperature burns in children and individuals with limited mobility.
- Do not stand on the toilet or the lid.

Risk of Product Damage

- Keep flammable materials, such as drapes, or any open flame, such as lighted candles or cigarettes, away from this appliance.

CAUTION

Water Hazards

- Do not pour water or liquid cleaners into any part of this appliance.
- Never operate this appliance if it has a damaged cord or plug, if it is not working properly, or if it has been dropped or damaged.

- Do not install this appliance in a location exposed to excessive moisture. Ensure adequate ventilation to prevent damage to the electronic components caused by high humidity levels.

Structural Integrity

- Avoid excessive force when opening or closing the lid.
- Do not apply excessive force to the nozzle.
- Do not modify or attempt to repair the appliance yourself, unless as specifically instructed in the user manual.

GENERAL USE

- Unplug the product if it will not be used for an extended period of time.
- Avoid dropping any non-flushable items into the bowl.
- Avoid harsh cleaning agents and abrasives that could damage plastic components or the toilet surface. Use gentle, non-abrasive cleaners recommended for electronics or bathroom fixtures.

SAVE THESE INSTRUCTIONS

Getting Started



Thank you for choosing ERIDANUS

To ensure proper operation, it is highly recommended to follow these instructions to inspect whether the received unit is in good condition before installation.

Basic Connections

- Plug the power cord into a grounded AC 110V outlet.
- Check if the indicator lights up to confirm power is connected.
- Connect supply lines to water supply using an angle valve.
- Open the valve.

Pre-Use Checks



NOTE Place your hand on the sensor area to activate the seat sensor for testing functions that require such.

Keep your hand in front of the nozzle during washing test to prevent splashing.

- Inspect the nozzle and supply lines for any leaks.
- Test the washing, drying, flushing functions* to ensure they function properly.
- Ensure that the soft-closing mechanism for the toilet seat and lid functions properly.

* Actual functions may vary from models.

Specifications



Parts Diagram :

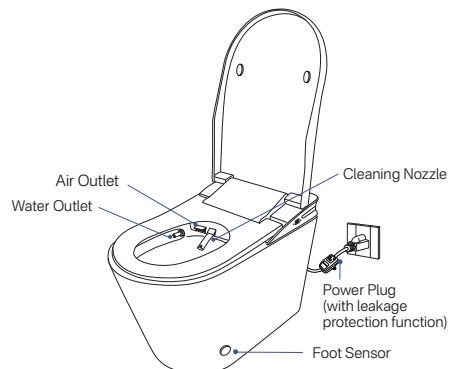
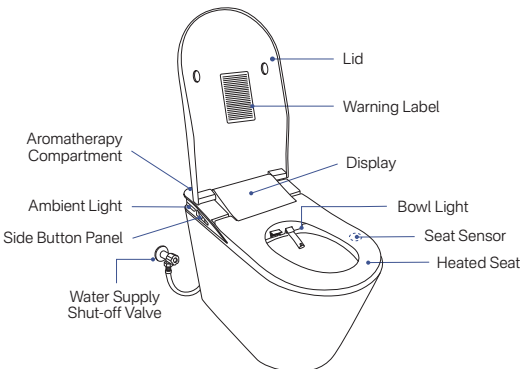

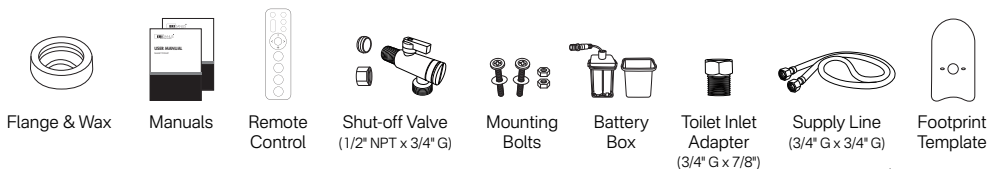

Technical Data :

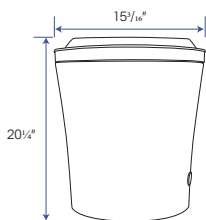

Front View

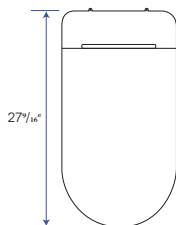

Top View

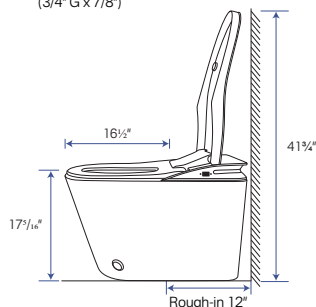

Side View

Parameter		Specifications				
Rated Voltage		AC 110V-120V, 60 Hz				
Rated Power		1350W				
Washing Function	Flow Rate	Feminine Wash	23 oz/min			
		Rear Wash	23 oz/min			
	Water Temp		Room temp	93°F	96°F	99°F
	Heating Mode		Instant Heat			
Heating Power		1350W (Max)				
Seat Heating	Seat Temp		Room temp	93°F	96°F	99°F
	Heating Power		40W			
Air Drying	Air Temp		01(Room temp)	02(95°F)	03(113°F)	04(131°F)
Water Pressure Requirement		20 -105 psi (static), Approx. 1.32 Gal in 15 seconds				
Nozzle Position		Adjustable front and back				
Toilet	Overall Dimensions		27 ⁹ / ₁₆ " x 15 ³ / ₁₆ " x 20 ¹ / ₄ "			
	Net Weight		93.3 lbs			
	Seat Height		17 ⁵ / ₁₆ "			
	Rough-in		12"			
Remote Control	Overall Dimensions		7 ¹ / ₂ " x 2" x ³ / ₄ "			
	Power Requirement		Two AAA Batteries			

Features



Wash Features

Feminine Wash	Features adjustable water pressure, adjustable water temperature, and an oscillating feminine mode, with a default duration of 90 seconds.
Rear Wash	Features adjustable water pressure, adjustable water temperature, and an oscillating rear mode, with a default duration of 90 seconds.
Toddler Wash	Features adjustable water temperature with the gentlest water pressure and an oscillating mode for toddler posterior washing, with a default duration of 90 seconds. Automatically activates air drying session once washing is complete.
Air Drying	Features adjustable air temperature for skin drying after washing, lasting three minutes by default.
Oscillating Mode	Provides a consistent back-and-forth motion for the targeted washing area for an enhanced cleaning.
Adjustable Water Temp	Provides four levels of water temperature adjustment: room temp, 93°F (34°C), 96°F (37°C), 99°F (40°C).
Adjustable Water Pressure	Provides four levels of water pressure adjustment: gentle, medium, strong, extra strong.
Adjustable Air Temp	Provides four levels of air drying temperature adjustment: 01(room temp), 02(95°F), 03(113°F), 04(131°F).

Flush Features

Power-Assisted Flush	Utilizes power to generate a forceful siphonic jet flush.
Seat-Sensor Flush	When enabled, seat sensor triggers automatic flushing upon detecting user leaving.
Foot-Sensor Flush	With seat unoccupied, foot sensor triggers automatic flushing upon detecting foot motions or proximity.
Blackout Flush	Supports power-assisted flush during power outage (battery required).

Light Features

Screen Display	When activated, screen displays current temperature based on latest mode set.
Night Light	When activated, soft light illuminates from the bowl.
Ambient Light	When activated, light illuminates on both sides of toilet.

Seat & Lid Features

Seat Sensor	Located on the front right side of seat as to detect a seated user. Wash features will not be activated without a seated user.
Auto Open /Close	When enabled, the lid automatically opens when motion sensor detects user approaching. Five levels of sensor range are available: 8"(20 cm), 16"(40 cm), 24"(60 cm), 32"(80 cm), 40"(100 cm). Sensor range may vary depending on bathroom layout.
Heated Seat	When enabled, the seat warms up with adjustable thermostat settings.
Soft Close	Features a soft and silent close when powered on.
Adjustable Seat Temp	Provides four levels of seat temperature adjustment: room temp (off), 93°F (34°C), 96°F (37°C), 99°F (40°C).

Cleaning Features

Pre Wetting	When enabled, flushing system automatically moistens the toilet bowl before use.
Self-Cleaning Nozzle	Cleaning nozzle automatically rinses itself before and after each use.

Air Freshening	Add a few drops of essential oil or air freshener to the designated area to ensure your bathroom stays fresh and clean.
----------------	-------------------------------------------------------------------------------------------------------------------------

Operation Options

Remote Control	The remote control operates the toilet features when paired with the unit.
Control Buttons	Located on the left side of the toilet for easy and quick access to its main features.

Other Features

Foot-Sensor Opening	Only activated when auto-open/close feature is disabled. Foot sensor triggers cover opening upon detecting foot motions or proximity.
Manual Cleaning Mode	Temporarily disables the automatic flush and extends the nozzle for manual cleaning.

Operations

Remote Control

Set up

- The remote control must be charged to operate.
- Make sure two AAA batteries are correctly installed.
- Press any button on the remote control to complete setup.

Pairing the Remote Control with the Toilet

NOTE The remote control is pre-paired with the toilet at the factory. No setup is required unless replacing the remote or the toilet unit.

1. Make sure i) the toilet is powered on, ii) the seat sensor is not activated.
2. Press and hold the left side fourth control button (rear wash) for three seconds until you hear a beep.
3. Press any button on the remote control near the desired toilet for pairing.
4. Pairing completes when you hear a beep and display stops flashing.

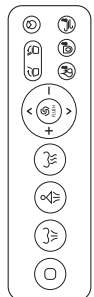

Operations



Press once to terminate current washing or drying session.
Press and hold to turn the power on or off.



Press once to start a 90-second rear wash.
Press again to switch to the oscillating rear wash.



Press once to start a 90-second feminine wash.
Press again to switch to the oscillating feminine wash.



Press once to start a 3-minute air drying session.



Press to adjust the nozzle position forward or backward during rear wash and feminine wash, only when oscillating mode is not activated.



Press to increase or decrease the water pressure, ranging from gentle, medium, strong, to extra strong.



Press once to start a power-assisted siphon flush.
Press and hold to turn the auto flush function on or off.



Press once to open/close the toilet lid.
Press and hold to turn the auto open/close function on or off.



Press once to open/close the toilet seat.



Press once to activate foam shield function (If applicable).
Prevents splashing, reduces dirt adhesion, and blocks odors.



Simply press this button to adjust water temp for washing between four gears: room temp, 93°F (blue button indicator), 96°F (purple), and 99°F (red).



Simply press this button to adjust seat temp between four gears: room temp, 93°F (blue button indicator), 96°F (purple), and 99°F (red).



Simply press this button to adjust air temp for drying between four gears: room temp(display number: 01), 95°F (blue button indicator, display number: 02), 113°F (purple button indicator, display number: 03), and 131°F (red button indicator, display number: 04).



Press once to start the auto-cleansing session for nozzle.
Press again to terminate the session.

















Press once to turn the night light on.
Press again to turn the night light off.







Press once to start a 90-second toddler wash.
Press again to switch to the oscillating toddler wash.

Control Buttons

Power Status	Seat Sensor Status	Operation		
On	Deactivated	Power On/Off	Press and Hold: Power On/Off	Press: Flushing
		Warm Air Drying	-	
		Feminine Wash	Press: Ambient Light Color	
		Rear Wash	-	
	Activated	Power On/Off	Press and Hold: Power On/Off	Press: Stop Washing/Drying
		Warm Air Drying	Press Two Times: Air Drying	
		Feminine Wash	Press Once: Feminine Wash	Again: Oscillating
		Rear Wash	Press Once: Rear Wash	Again: Oscillating
Off - Connect the Backup Battery	-	Press and Hold	Flushing Session	

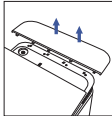
Feature	Operation
Turn Pre-Wet on/off	<ol style="list-style-type: none"> 1. Press and hold  until the toilet turns off (one beep). 2. Press and hold  for 3 seconds: One beep: Pre-wet function now off. Two beeps: Pre-wet function now on. 3. Press and hold  again to turn the toilet back on (one beep).
Auto Open Detection Range Adjustment	<ol style="list-style-type: none"> 1. Press and hold  until the toilet turns off (one beep). 2. Press  to enter radar distance adjustment mode (one beep). 3. Press "" and "" buttons to adjust the range (1-5): Level 1: 8" (20 cm) Level 2: 16" (40 cm) Level 3: 24" (60 cm) Level 4: 32" (80 cm) Level 5: 40" (100 cm) 4. Press and hold  again to turn the toilet back on (one beep).
Turn Auto Open on/off	<ol style="list-style-type: none"> 1. Press and hold  for 3 seconds: One beep: Auto Open now off. Two beeps: Auto Open now on.
Turn Auto Flush (user leaving) on/off	<ol style="list-style-type: none"> 1. Press and hold  for 3 seconds: One beep: Auto Flush (user leaving) now off. Two beeps: Auto Flush (user leaving) now on. <p>*The feature will only activate if the seat sensor detects that the user has been seated for more than 20 seconds.</p>
Turn Auto Flush (lid closing) on/off	<ol style="list-style-type: none"> 1. Press and hold  until the toilet turns off (one beep). 2. Press and hold  for 3 seconds: One beep: Auto Flush (lid closing) now off Two beeps: Auto Flush (lid closing) now on 3. Press and hold  again to turn the toilet back on (one beep).
Turn Heated Seat on/off	<ol style="list-style-type: none"> 1. Simply press  to adjust seat temperature: Seat temp level (remote indicator light): Level 1: Room temp (light off) Level 2: 93°F (blue light) Level 3: 96°F (purple light) Level 4: 99°F (red light)

<p>Turn Heated Water on/off</p>	<p>1. Simply press  to adjust water temperature: Water temp level (remote indicator light): Level 1: Room temp (light off). Level 2: 93°F (blue light). Level 3: 96°F (purple light). Level 4: 99°F (red light).</p>
<p>User Memory Function</p>	<p>No setup required. Toilets operates with user's latest settings, include seat temp, water temp, air temp, water pressure, and nozzle position.</p>
<p>Factory Reset</p>	<p>Unplug the power, wait 30 minutes, then plug it back in to reset to factory settings.</p>
<p>Foot Sensoring Operations</p>	<p>With auto open/close function disabled and seat and lid closed, motions near the foot sensor area trigger the lid opening.</p> <p>With lid open, motions near the foot sensor area trigger the seat opening.</p> <p>With seat open, motions near the foot sensor area trigger the flushing.</p> 
<p>Air Freshening</p>	<p>Remove the rear cover.</p> <p>Add a few drops of essential oil or air freshener to the designated area. Replace the cover back to its position.</p> <p>The aroma diffuser releases fragrance automatically.</p>  

Toilet

- Please refer to Eridanus installation guide for toilet installation.

Remote Control

- The shelf can be wall-mounted using either peel-and-stick adhesive or screws. It's highly recommended that the remote be installed within reach when seated.

Backup Battery

Four AA batteries (not included) are required to support power-assisted flush during an outage. Followings are steps for setting up backup battery:

1. Insert four new AA batteries into the toilet's built-in battery box, ensuring proper orientation.
2. Locate the connection wire at the back of toilet , matching connectors at both ends of wire and battery box.
3. Screw the connectors together and secure the connection.

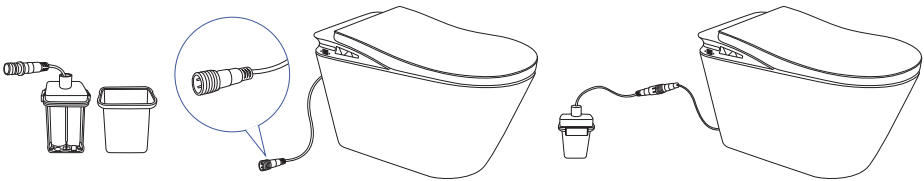

Maintenance



Eridanus smart toilets are meticulously crafted and have undergone strict quality inspection to ensure each unit lasts for years to come. As a combination of plumbing fixtures and appliances, Eridanus toilets would require regular care as to maintain their hygiene and functionality. Proper maintenance guarantees longevity and optimal performance.

General Maintenance

Disconnect Power Before Maintenance/Service

- Always disconnect the power supply before performing any maintenance tasks to prevent personal injury or property damage.

Avoid Water Exposure

- Do not allow water to enter the control panel or electrical components.

Avoid Excessive Moisture

- Ensure adequate ventilation to prevent damage to the electronic components caused by high humidity levels.

Regular Inspections

- Perform regular inspections of all components to ensure the toilet in good working order and address any issues promptly.

Regular Maintenance

Cleaning the Toilet Bowl

- Use a non-abrasive toilet cleaner.
- Apply the cleaner to the bowl, let it sit for a few minutes, then scrub with a toilet brush.
- Avoid using harsh chemicals or abrasive pads.

Cleaning the Nozzle

- Activate the nozzle cleaning mode via the control panel or remote.
- Use a soft brush or cloth to gently clean the nozzle.

Cleaning the Seat and lid

- Wipe the seat and lid with a damp cloth and mild detergent.
- Avoid using abrasive cleaners or scrubbing pads that could damage the surface.

- Dry with a soft cloth to prevent water spots.

Replacing the Air Freshener

- Remove the rear cover.
- Replace the air freshener, fragrance, or essential oil in the designated area.
- Replace the cover.



Replacing Batteries

- Locate the battery compartment at the rear of the toilet.
- Remove the old batteries and insert 4 new AA batteries.
- Ensure the battery is securely connected.

Troubleshooting



Power Troubleshooting

Problems	Possible Causes	Recommended Actions
Toilet has no power.	a) Power is not switched on. b) Power cord is disconnected from or loosely connected to the electrical outlet. c) The GFCI has tripped.	a) Press and hold the left  first control button for 3+ seconds, or "STOP" on remote control to turn on the power. b) Securely plug the power cord into a GFCI electrical outlet. c) Reset the GFCI.
Toilet does not respond.	a) Power is not switched on. b) Electrical power to the toilet is briefly interrupted. c) If the toilet responds to control buttons but not the remote control, pairing has failed.	a) Press and hold the left  first control button, or "STOP" on remote control to turn on the power. b) Turn OFF the power to the toilet completely, and restore the power. c) Pair the remote with toilet. Refer to "Remote Control" section.
Toilet beeps frequently.	a) Power cord is loosely connected to the electrical outlet. b) Specific functions, such as activating the seat sensor, cause a beep to confirm proper functioning.	a) Securely plug the power cord into a GFCI electrical outlet. b) No action is required.

Flushing Troubleshooting

Problems	Possible Causes	Recommended Actions
Toilet does not flush.	<ul style="list-style-type: none"> a) Supply valve is closed. b) Supply line is blocked or kinked. c) Remote control is not working. d) Toilet is clogged. 	<ul style="list-style-type: none"> a) Turn on the valve. b) Repair or replace the supply line. c) Refer to "Remote Control Troubleshooting" section. d) Use a plunger or snake to clear the clogs.
Flushing performance is not ideal.	<ul style="list-style-type: none"> a) Local water pressure is insufficient. b) Supply line or pipe is bent or blocked. c) The angle valve filter is clogged. 	<ul style="list-style-type: none"> a) Check if water pressure meets minimum requirement as specified in "Specifications" section. If not, a pump is needed. b) Replace the line or pipe. c) Check the filter status and clean or replace it if necessary.
Toilet does not flush automatically.	<ul style="list-style-type: none"> a) The automatic flush is disabled. b) Seat sensor is always deactivated. c) Seat sensor is always activated. 	<ul style="list-style-type: none"> a) Refer to the "SETTINGS GUIDE" section to enable the feature. b) The sensor may be blocked by other physical objects, preventing user detection. Clean the sensor area and remove any debris. c) Sensor is covered by other physical objects to stay in the activated status. Clean the sensor area and remove any debris.
Toilet flushes unexpectedly.	<ul style="list-style-type: none"> a) The automatic flush is enabled. 	<ul style="list-style-type: none"> a) When enabled, unexpected flushes may occur due to the foot sensor or accidental touches on the remote control or side button panel. In most cases, no action is required.

Wash & Dry Troubleshooting

Problems	Possible Causes	Recommended Actions
Wash function does not work.	<ul style="list-style-type: none"> a) Supply valve is closed. b) Supply line is blocked or kinked. c) Remote control is not working. d) Seat sensor is always deactivated. e) Seat sensor is always activated. 	<ul style="list-style-type: none"> a) Turn on the valve. b) Repair or replace the supply line. c) Refer to " Remote Control Troubleshooting " section. d) Sensor is blocked by other physical objects to detect user. Clean the sensor area and remove any debris. e) Sensor is covered by other physical objects to stay in the activated status. Clean the sensor area and remove any debris.
Nozzle stops spray after some time.	<ul style="list-style-type: none"> a) All wash mode stops automatically after 90 seconds by default. 	<ul style="list-style-type: none"> a) No action is needed. Reactivate the function using the remote control or control buttons.
No water sprays from the nozzle.	<ul style="list-style-type: none"> a) Supply valve is close. b) Supply line is blocked or kinked. c) Nozzle is blocked. 	<ul style="list-style-type: none"> a) Turn on the valve. b) Repair or replace the supply line. c) Turn on the auto-cleansing mode and manually clear any blockage on the nozzle.
Water flow is not ideal.	<ul style="list-style-type: none"> a) Water pressure is set as gentle. b) The angle valve filter is clogged. c) Nozzle is blocked. 	<ul style="list-style-type: none"> a) Turn up the water pressure using remote control . b) Inspect filter and clean or replace if necessary. c) Turn on the auto-cleansing mode and manually clear any blockage on the nozzle.
Water is not heated.	<ul style="list-style-type: none"> a) Water temperature is set to room temperature. 	<ul style="list-style-type: none"> a) Turn up the water temp using remote control.

During cleaning, the nozzle does not extend.	<ul style="list-style-type: none"> a) Power is not connected. b) Water supply is abnormal. 	<ul style="list-style-type: none"> a) Connect the power supply. b) 1. Ensure the supply valve is fully open. 2. Check if the hose is blocked or bent. <p>If the nozzle still does not operate after performing the above steps, please contact us.</p>
The nozzle no longer retracts.	/	Press the nozzle back in by hand, unplug the power cable, wait for about 30 minutes, then plug the power back in and check if the nozzle can be restored. If the issue persists, please contact us for assistance.
Dryer is too hot.	<ul style="list-style-type: none"> a) Air drying temperature is set to a higher level. 	<ul style="list-style-type: none"> a) Turn down the air temp using remote control.

Seat & lid Troubleshooting

Problems	Possible Causes	Recommended Actions
Seat is not heated.	<ul style="list-style-type: none"> a) Seat temp is set as room temp. 	<ul style="list-style-type: none"> a) Turn up the seat temp using remote control.
Lid opens unexpectedly.	<ul style="list-style-type: none"> a) Motion sensor detects user approaching. 	<ul style="list-style-type: none"> a) No action is required. Refer to "SETTINGS GUIDE" section to adjust the sensor range if needed.
Lid does not open automatically.	<ul style="list-style-type: none"> a) This model does not feature auto open/close function. b) Auto open/close is disabled. c) A rare case caused by a complex bathroom layout and sensor range. 	<ul style="list-style-type: none"> a) No action is needed. b) Refer to "SETTINGS GUIDE" section to enable the feature. c) Adjust sensor range and re-test the feature.

Remote Control Troubleshooting

Problems	Possible Causes	Recommended Actions
The remote control does not work.	<ul style="list-style-type: none"> a) Inproper installation of batteries. b) The batteries need to be replaced. c) Remote control does not pair with toilet. b) Remote control is distant from toilet. 	<ul style="list-style-type: none"> a) Correctly reinstall the batteries. b) Replace batteries. c) Refer to " Remote Control " section as to pair remote with toilet. d) Operate remote control near toilet.

Frequently Asked Questions



Question	Answer
Water pressure is insufficient, resulting in poor flushing performance. What should I do?	Install a booster pump at the toilet's supply to ensure adequate water pressure.
How to flush during a power outage?	Ensure that the backup battery is installed. Press and hold the 'Wash' button  on the left side of toilet for five seconds until a beep confirms flushing activation.
Is the hot water continuous, or is there a wait time for heating?	There is no need to wait for heating. The hot water is supplied instantly, as the heater quickly raises the water temperature, providing a continuous flow of hot water.
How can I tell if the nozzle is undergoing an auto cleaning session?	The nozzle automatically performs self-cleaning before and after each cleaning session, just before water sprays out.
How to manually clean the nozzle?	Press 'Auto' button on the back of the remote. Gently clean the nozzle with a soft tool.
Can I turn off flushing before the drying session?	No, the model requires flushing before the drying session begins.
The drying session takes too long. What can I do?	<ul style="list-style-type: none"> a. Adjust the drying temperature. b. Wipe off excess water to significantly reduce drying time.
Will the seat remain heated after I leave?	<p>Yes, the seat maintains the preset temperature for comfort.</p> <p>For energy efficiency, we advise setting the seat temperature to room temperature via the remote control after use.</p>

Can I manually close the toilet lid and seat?	For model with Auto Open, it's recommended to use the remote control or foot sensor to operate the lid and seat.
Will lid automatically close after leaving the seat?	For model with Auto Open, lid closes 90 seconds after user leaves the seat, regardless of Auto Open status.
How to turn off the ambient light on the back of the toilet?	The ambient light turns off automatically 10 minutes after user leaves.
How to turn off the LED screen on the toilet?	The LED screen turns off automatically 10 minutes after user leaves.
I cannot find some functions on my remote. Where are they?	Toddler wash, Nightlight, and Auto Nozzle Cleaning are located on the back of the remote.
Why do the previous settings disappear after a power outage?	The toilet resets to factory settings if power is disconnected for more than 30 minutes.
Is the toilet waterproof?	The toilet has an IPX4 water resistance rating.
The included shut-off valve is not compatible with existing plumbing. What should I do?	<p>Option A: Please refer to the installation manual included in your package, which provides three different methods for connecting water pipes. If you require the additional shut-off valve mentioned in the third installation method, or if you have any questions about the installation, please contact our customer service via email.</p> <p>Option B: For a quicker solution, you can check local plumbing codes and purchase a compatible adapter locally.</p>
What is the Default factory setting?	<ul style="list-style-type: none"> • Auto Open: Activated Detection Range: 24" (60 cm) (If applicable) • Heated Seat: Activated Temperature: 96°F (36°C) • Cleaning Water Temperature: 96°F (36°C) • Pre-Wet Function: Activated • Auto Flush: Activated

Contact Information

 Email

support@eridanus.net

For any issues with installation, operation, or the product itself, please contact our after-sales service team at the email below. We will respond within 1 business day.

User Manual

COPYRIGHT 2025 ERIDANUS