

# **VEVOR<sup>®</sup>**

**TOUGH TOOLS, HALF PRICE**

Technical Support and E-Warranty Certificate [www.vevor.com/support](http://www.vevor.com/support)

## **PIPE STANDS**

**MODEL: 1104A**

We continue to be committed to provide you tools with competitive price.

"Save Half", "Half Price" or any other similar expressions used by us only represents an estimate of savings you might benefit from buying certain tools with us compared to the major top brands and does not necessarily mean to cover all categories of tools offered by us. You are kindly reminded to verify carefully when you are placing an order with us if you are actually saving half in comparison with the top major brands.

# VEVOR<sup>®</sup>

TOUGH TOOLS, HALF PRICE

## PIPE STANDS

**MODEL: 1104A**





### **NEED HELP? CONTACT US!**

Have product questions? Need technical support? Please feel free to contact us:

**Technical Support and E-Warranty Certificate**  
**[www.vevor.com/support](http://www.vevor.com/support)**

This is the original instruction, please read all manual instructions carefully before operating. VEVOR reserves a clear interpretation of our user manual. The appearance of the product shall be subject to the product you received. Please forgive us that we won't inform you again if there are any technology or software updates on our product.

	<p>Warning-To reduce the risk of injury, user must read instructions manual carefully.</p>
	<p>Wear protective gloves.</p>

## SAFETY WARNINGS AND PRECAUTIONS

Thank you for using this product. In order to make sure that you can operate the machine correctly, read this instruction carefully before operation and keep it properly for future reference. Please read the precautions and safety rules on this page to ensure your safe use. This manual will outline safety warnings and precautions, operating, maintenance and cleaning. The warnings and instructions reviewed in this manual cannot cover all possible conditions and situations that may occur. Caution and common sense are not built into this product, since we believe that the uses will comply with these codes.

- 1. Please read ALL the instructions before using your machine.**
- 2. Failure to properly support the pipe may result in tipping of the stand, dropping of the pipe, or serious injuries.**
- 3. Use the appropriate safety equipment for the intended job such as eye protection, hearing protection, feet protection, dusk masks, face shields, etc to reduce the risk of injuries.**

4. Assemble needs to follow these instructions. Incorrect assembly can be a hazard. Wear heavy-duty work gloves during assembly.
5. Do not assemble and use when tired or when under the influence of alcohol, drugs or medication.
6. Keep the assembly area clean and well-lit.
7. Keep bystanders out of the area during assembly.
8. Do not allow children and pets to play alone or approach this item. Don't Climb Products.
9. **Inspect before every use.** Do not use it if parts are loose or damaged.

Be aware of the following potential hazards:

- Missing, damaged or improperly positioned frame padding.
- Bent or broken frame.

- Loose or missing bolts. Loosened legs.
10. People or objects hanging on the product will cause the product to fall.
  11. Pay attention to pedestrians and vehicles when using.
  12. Do not apply this unit to any other purposes than the indicated usage. No changes to any parts or structure of the product are allowed.
  13. DO NOT CLEAN IT WITH ANY ABRASIVE MATERIAL.
  14. Never leave it unattended while in use.
  15. Do not stand or sit on the product.
  16. Pet urine and feces can damage the product, please keep away.
  17. Do not place the product on or near hot air, electric burners or heaters.
  18. The product should be placed on a flat surface. And it should be installed in an open and safe place.
  19. This appliance is not intended for use by persons (including children) with reduced physical, sensory or mental capabilities, or lack of experience or knowledge.
  20. Must be obeyed pipe diameter size / weight / high limit: check size chart.
  21. Make sure there are no people, children, pets, animals, obstructions underneath the product.
  22. Artificial illumination may be required for indoor or shady areas.
  23. The metal frame of the product can conduct electricity. All lamps, extension cords and similar electronic devices must not come into contact with the frame.
-  **WARNING:**
- 24. This appliance is not intended for use by young or infirm persons. Young children should be supervised to ensure that they do not play with the product. Pets should stay away from the product. Do not use outdoors on rainy and cloudy days and strong wind conditions, avoid lightning strikes and falls.**
  - 25. Hand screw, wear, damage, or other issues that may affect safe usage. If any problems are found, discontinue use until the stand is repaired. Keep the stand clean and all moving parts lightly lubricated to aid in operation.**
  - 26. Be careful not to dump the product when placing the pipeline.**
  - 27. The product may be unstable when it rises to the maximum height, please pay attention!**

## MAX SIZE / WEIGHT

Pipe diameter size limit: **1/2 inch to 12 inch (12.7mm to 304.8mm )**

Max Weight limit: **Max2500 Pound ( about 1134Kg )**

Height range: **27.95 inch to 51.97 inch ( 710-1320mm )**

**Attention:** 1. Do not exceed the limit value when using.





2. The product may be unstable when it rises to the maximum height, please pay attention!



**Notice:** Height refers to the ground to the lowest point of the V-groove.

## PRODUCT PARTS

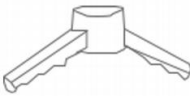
1. Please dispose of all plastic bags carefully and keep them away from children and pets.
2. Check all components provided according to the list in this manual. Make sure you have all of the parts listed.
3. Although paying particular attention when manufacturing this product, you must be careful during the assembly process to avoid being scratched by sharp edges.
4. Wear protective gloves, during assembly and use.
5. The product should be placed on a flat surface.

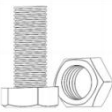
**Notice:** The quantity of parts shown in the manual is the actual usage and the unused parts are spare parts.

Parts No.	Picture	Qty	Parts No.	Picture	Qty
1 V head &Screw		1 PCS	6 Support foot		3 PCS
2 Adjusting handle		1 PCS	7 Connection Strap		6 PCS
3 Safety Clasp		1 PCS	8 Nut & blot		9 sets

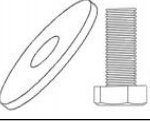
4 Special lock nut		2 PCS	9 Steel pipe		1 PCS
5 Support body		1PCS	10 Bolt & Safety Clasp		1 PCS

## EXPLOSION DIAGRAM

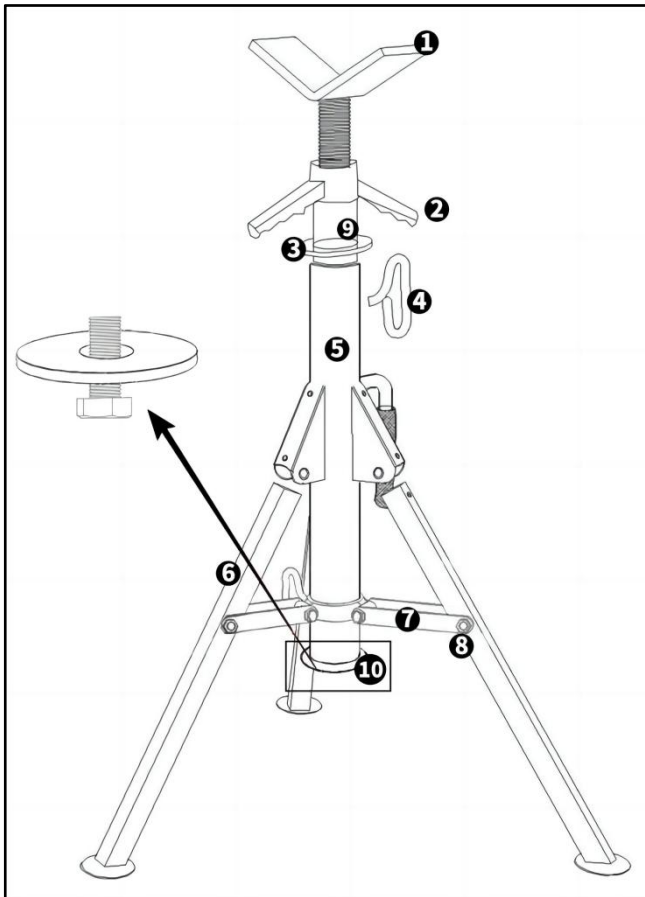

**Notice:** The product should be placed on a flat surface. Please check whether the product is installed correctly and firmly, and read the safety information in the manual again.

## CLEANING AND STORAGE

1. Wipe with a soft, dry cloth. Never use an abrasive cleanser or harsh pad.
2. Children are **not allowed** to wipe the product to avoid tipping and falling injuries.
3. After disassembling the product, please assemble the parts and accessories. Be sure to keep the product dry.
4. Please clean regularly to avoid dirt.

**Notice:** Screw the bolts back into the product after removal to prevent them from being lost.

**Notice:** Always ensure that all legs are firmly screwed into place and that all bolts are tight before using again.

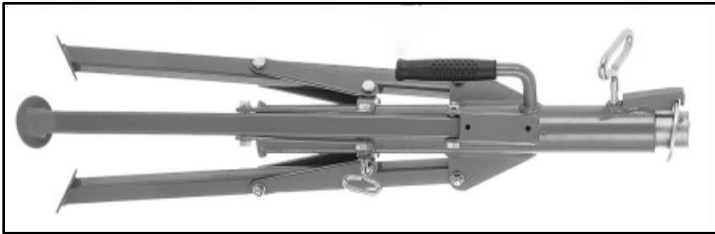

## TIPS

1. Lubricate with industrial grease regularly to prevent rust and improve the use effect.

**Address:** Baoshanqu Shuangchenglu 803long 11hao 1602A-1609shi Shanghai

**Imported to AUS:** SIHAO PTY LTD, 1 ROKEVA STREETEASTWOOD NSW 2122  
Australia

**Imported to USA:** Sanven Technology Ltd., Suite 250, 9166 Anaheim Place,  
Rancho Cucamonga, CA 91730



Pooledas Group Ltd  
Unit 5 Albert Edward House, The Pavilions  
Preston, United Kingdom



SHUNSHUN GmbH  
Römeräcker 9 Z2021, 76351  
Linkenheim-Hochstetten, Germany

**Made In China**

**VEVOR<sup>®</sup>**

**TOUGH TOOLS, HALF PRICE**

**Technical Support and E-Warranty Certificate**

**[www.vevor.com/support](http://www.vevor.com/support)**