

INSTRUCTION MANUAL

SKU: CM003-20SI-USZX

Model: CM003-20

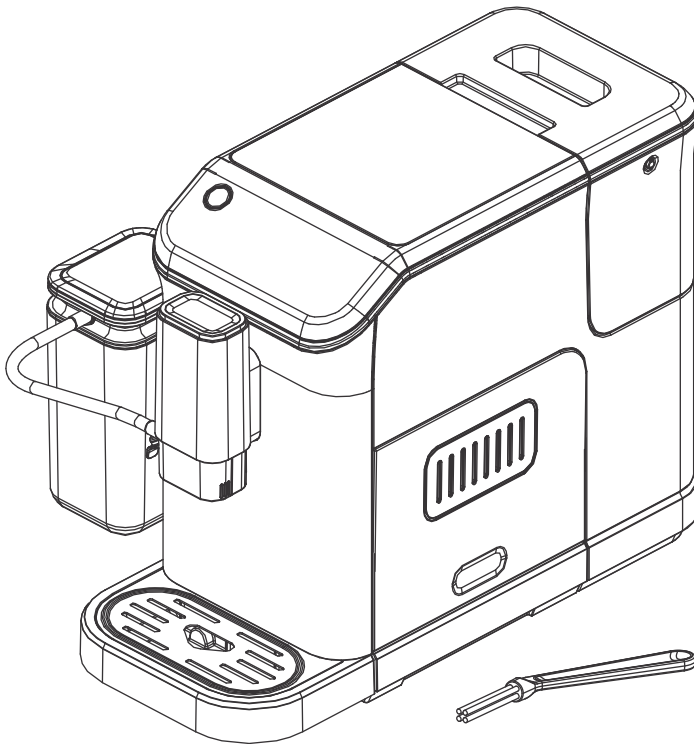

Contents

Important Safeguards	01
Know Your Coffee Machine	04
Control Panel	05
Before First Use	06
Operation	09
Cleaning And Maintenance	16
Hints For Great-Tasting Coffee	23
Troubleshooting	24
Warranty Policy	28

IMPORTANT SAFETY INSTRUCTIONS

When using electrical appliances, basic precautions should always be followed, including the following:

1. Read all Instructions, Save these instructions.
2. Before using check that the voltage power corresponds to the one shown on the appliance nameplate.
3. If the supply cord is damaged, it must be replaced by the manufacturer, its service agent or similarly qualified persons in order to avoid a hazard.
4. Appliances can be used by persons with reduced physical, sensory or mental capabilities or lack of experience and knowledge if they have been given supervision or instruction concerning use of the appliance in a safe way and they understand the hazards involved.
5. Keep the appliance and its cord out of reach of children.
6. This appliance shall not be used by children. Children should be supervised to ensure that they do not play with the appliance.
7. Close supervision is necessary when any appliance is used by or near children.
8. Cleaning and user maintenance shall not be made by children unless they are supervised.
9. To disconnect, turn any control to **"OFF"**, remove plug from wall outlet. Always hold the plug. But never pull the cord.
10. Unplug from outlet when not in use and before cleaning. Allow to cool before putting on or taking off parts, and before cleaning the appliance.
11. The use of accessory not recommended by the appliance manufacturer may result in fire, electric shock or injury to persons.
12. **Do not** use outdoors.
13. **Do not** use appliance for other than intended use.
14. **Do not** let cord hang over edge of table or counter, or touch hot surface.
15. **Do not** place on or near a hot gas or electric burner, or in a heated oven.

16. Do not let the coffee machine operate without water.
17. To protect against fire, electric shock and injury to persons do not immerse cord, plug, or appliance in water or other liquid.
18. Be careful not to get burned by the steam during the brewing cycles.
19. Some parts of appliance are hot when operated, so do not touch with hand. Use handles or knobs only.
20. The appliance must not be immersed.
21. For household use only.
22. A warning of potential injury from misuse.
23. The heating element surface is subject to residual heat after use.
24. The coffee-maker shall not be placed in a cabinet when in use.
25. Switch off the appliance and disconnect from supply before changing accessories or approaching parts that move in use.
26. CAUTION: In order to avoid a hazard due to inadvertent resetting of the thermal cut-out, this appliance must not be supplied through an external switching device, such as a timer, or connected to a circuit that is regularly switched on and off by the utility.
27. Always disconnect the appliance from the supply if it is left unattended and before assembling, disassembling or cleaning.
28. The operating or storage temperature of the coffee machine should be more than 10 °C.
29. Follow the instructions above, including the instructions in the section "CLEANING AND MAINTENANCE".
30. Do not open the lid during the operation. Scalding may occur if the lid is removed during the brewing cycles.
31. WARNING: To avoid the risk of injury, do not open the brew chamber during the brew process.
32. Avoid contacting moving parts. Do not attempt to defeat any safety interlock mechanisms.
33. Check hopper for presence of foreign objects before using.

34. Notes of power cord:

- a. A short power-supply cord (or detachable power-supply cord) is provided to reduce risks resulting from becoming entangled in or tripping over a longer cord.
- b. Longer detachable power-supply cords or extension cords are available and may be used if care is exercised in their use.
- c. If a long detachable power-supply cord or extension cord is used:
 - 1) The marked electrical rating of the detachable power-supply cord or extension cord should be at least as great as the electrical rating of the appliance;
 - 2) If the appliance is of the grounded type, the extension cord should be a grounding-type 3-wire cord;
 - 3) The longer cord should be arranged so that it will not drape over the counter top or table top where it can be pulled on by children or tripped over.

35. Always attach plug to appliance first, then plug cord into the wall outlet.

36. Save these instructions.

KEY COMPONENTS AND STRUCTURE

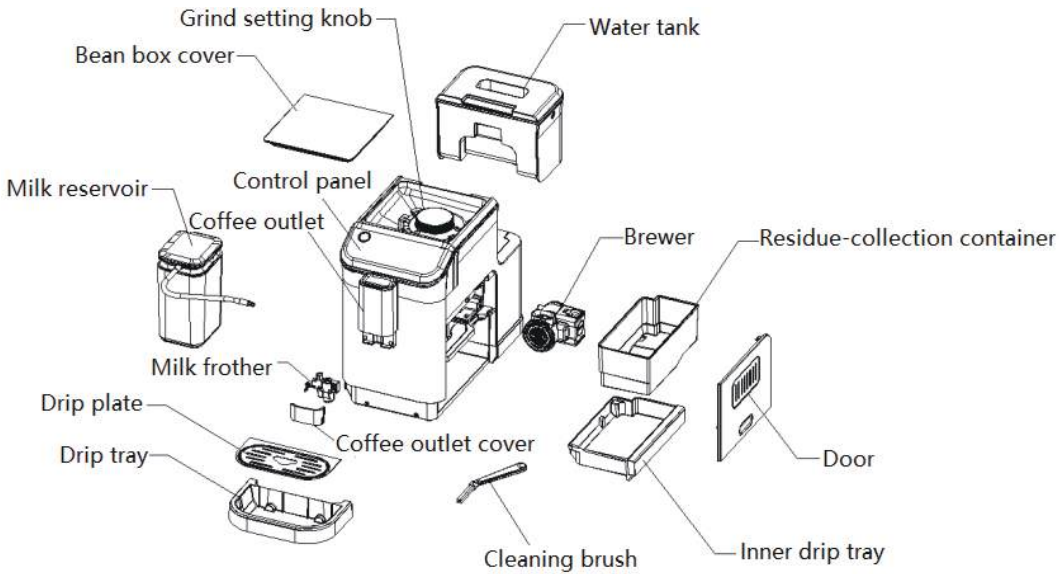

Technical Specifications

Model:	CM003-20
Power Supply:	120V 60Hz
Water Tank Capacity:	1.5 L/51 oz
Milk Container Capacity:	750 ml/26 oz
Bean Hopper Capacity:	180 g/6.3 oz
Dimensions:	18.3 in × 7.1 in × 12.4 in
Net Weight:	19.06 Lbs.

CONTROL AND DISPLAY PANEL

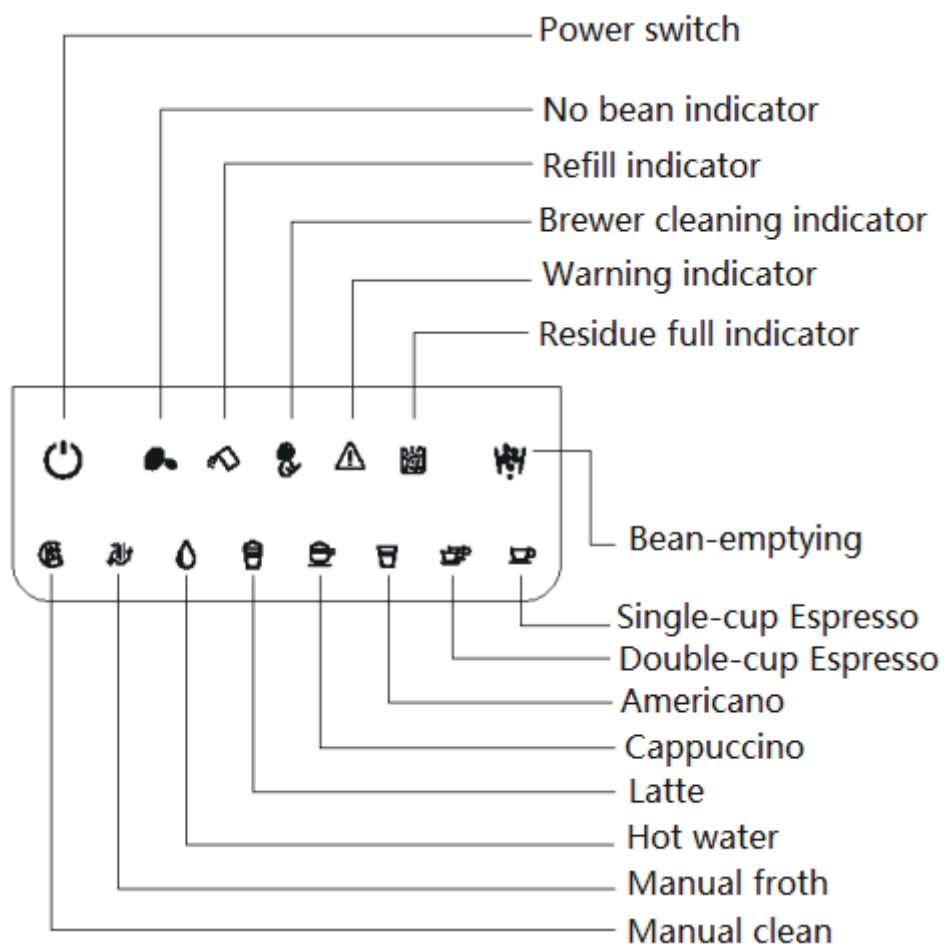

BEFORE FIRST USE

Check that all accessories are complete and the unit is not damaged. Check and understand all the parts and their functions. It is recommended to keep the original packaging for future use. And then follow the operations as below.



1. Before using for the first use, please remove the water tank, milk reservoir, brewer and milk frother and rinse them with clean water.

2. Check and make sure all the removable parts are installed well in position:

(1) Water tank:

Fill the water tank with fresh water up to Max mark and then reassembly it into the unit and make sure it is properly assembled, and then close the water tank lid.



(2) Milk reservoir:

① Insert the milk tube into the hole of milk frother at the side of coffee outlet.

② Move the milk tube from the milk reservoir lid and then insert it into the milk reservoir lid.

③ Install the milk reservoir and milk reservoir lid well in position.

④ The milk tube can be folded, and please install it firmly by yourself if it is loose.



(3) Grind setting knob

① Turn the grind setting knob bracket counterclockwise to the leftmost.

② Cover the grind setting knob according to the specified position.

③ Select the grinding setting clockwise.

NOTE: When the new coffee machine is used for the first time, it is suggested that the grind setting higher than setting 8 shall be selected. The adjustable grind settings range between 1 (finest) and 15 (coarsest), the number on the grind setting knob pointed by the arrow is the actual selected grind setting.

CAUTION: We suggest to adjust one notch at one time to avoid the damage.



(4) Milk frother

- ① Open the coffee outlet cover and make sure the milk frother is installed well in position.
- ② If the milk frother is installed well in position, please close the coffee outlet cover and then insert the connecting tube.
- ③ Insert the other end of the connecting tube into the milk reservoir.



(5) Adjustment for the height of coffee outlet

- ① The adjustable height of coffee outlet ranges between 85 and 115mm.



(6) Brewer

- ① Open the door and check whether the brewer is installed well in position.
(A) Check whether the arrow of the brewer is aligned with the arrow of the upper bracket
(B) An audible click indicates that the assembling of brewer is correct .
(C) The warning indicator "⚠" will light solidly if the brewer is not installed in place.
- ② Close the door
(A) The whole door and body are on the same horizontal plane.
(B) The warning indicator "⚠" will flash if the door is not closed properly.



(7) Inner drip tray and residue-collection container

- ① Open the door and check whether the drip tray is installed in place.
- ② Open the door and check whether the residue-collection container is installed in place.
- ③ The inner drip tray will not be installed well in position, the warning indicator "⚠" will be on and the machine can not work if there is foreign object at the front of the residue-collection container.



(8) Drip plate

① Place the drip plate on the drip tray. The drip plate must be installed well in position so that the container can be placed on it for holding coffee, milk or hot water.

② Insert the drip tray into the appliance.

NOTE: The drip tray collects the water from the dispensing spout during each rinse & self-cleaning as well as coffee that might be spilled during brewing . So clean and empty the drip tray everyday.

(9) Fill the bean box with proper amount of fresh coffee beans, 180g at most, and then close the bean box cover.

CAUTION: If the grinding blade is removed, please make sure that the grinding blade has been installed well in position before filling the bean box with coffee beans.

OPERATION

This appliance is a multifunctional coffee machine, it has the functions of "Single-cup Espresso", "Double-cup Espresso", "Americano", "Cappuccino", "Latte", "Hot water", "Manual froth", "Manual clean" and "Bean-emptying".

SPECIAL NOTE: The appliance will perform cleaning automatically to make preparation for operation when it is started each time.



NOTE: The coffee will come out drip by drip at the beginning (2-3 seconds after the brewing is started) and the end (6-8 seconds before the brewing is completed) during the brewing process, this is normal.
Power on and Preheat

1. Connect the appliance with rated voltage and press the On/Off button at the back side of the appliance.

2. Hold and press the Power switch "🔌" for at least 0.3 second and its corresponding indicator flashes, and then the appliance enters into the self-check status.

NOTE: Please refer to the section of "TROUBLESHOOTING" to operate if there is warning occurred.

3. Place a container under the coffee outlet.

4. The Manual clean indicator "🧼" illuminates solidly and the indicator of Power switch "🔌" flashes, then the appliance enters into the preheating stage and the auto-clean status.

5. After the preheating of coffee boiler is completed, the indicators of Single-cup Espresso "☕", Double-cup Espresso "☕", Americano "☕" and Bean-emptying "☕" illuminate solidly, and the appliance can be operated normally.

6. During the preheating of steam boiler, the indicators of Cappuccino "☕", Latte "☕", Hot water "💧", Manual froth "🌀" and Manual clean "🧼" flash, which means the appliance can not be operated. After the preheating of steam boiler is completed, the functional indicators will illuminate solidly and the appliance can be operated normally.

7. All the functional indicators will illuminate solidly after all the preheating stages are completed, and then the appliance will enter into the standby status.





Brew Single-cup Espresso

1. Place a coffee container under the coffee outlet.
2. Check and make sure the plug of milk frother is closed well in position.
3. Hold and press the Single-cup Espresso "☞" for at least 0.2 second and the appliance will start to brew single-cup of espresso. The indicator of Single-cup Espresso "☞" will illuminate solidly during the process of brewing single-cup of espresso.
4. After finish brewing single-cup of espresso, the appliance enters into the standby mode automatically.
5. Hold and press the Single-cup Espresso "☞" for at least 0.1 second again if need to cancel the current function.



Brew Double-cup Espresso

1. Place a coffee container under the coffee outlet.
 2. Check and make sure the plug of milk frother is closed well in position.
 3. Hold and press the Double-cup Espresso "☞" for at least 0.2 second and the appliance will start to brew double-cup of espresso. The indicator of Double-cup Espresso "☞" will illuminate solidly during the process of brewing double-cup of espresso.
- NOTE:** The double-cup espresso is achieved by brewing two cycles of single-cup espresso continuously, so please do not remove the coffee container during the brewing process.



4. After finish brewing double-cup espresso, the appliance enters into the standby mode automatically.



5. Hold and press the Double-cup Espresso "☞" for at least 0.1 second again if need to cancel the current function.



Brew Americano

1. Place a coffee container under the coffee outlet.
2. Check and make sure the plug of milk frother is closed well in position.



3. Hold and press the Americano “” for at least 0.2 second and the appliance will start to brew americano. The indicator of Americano “” will illuminate solidly during the process of brewing americano.

4. After finish brewing americano, the appliance enters into the standby mode automatically.

5. Hold and press the Americano “” for at least 0.1 second again if need to cancel the current function.

Brew Cappuccino

1. Place a coffee container under the coffee outlet.

2. Fill the milk reservoir with appropriate amount of cold milk.

NOTES:

(1) It is recommended that the temperature of milk should be 5-10 °C, and the protein content of milk should be at least 3%.

(2) The milk filled in the milk reservoir should not exceed the “MAX” mark on the milk reservoir.

3. Insert the milk tube well in position.

4. Remove the silicone tube from the milk reservoir lid and then connect it with the milk frother and milk reservoir lid.

5. Hold and press the Cappuccino “” for at least 0.2 second and the appliance will start to brew cappuccino.

6. After finish brewing cappuccino, the appliance enters into the standby mode automatically.

7. Hold and press the Cappuccino for at least 0.1 second again if need to cancel the current function.

NOTES:

1. After each use, if there is still milk in the milk reservoir, please store it in the refrigerator, but the silicone tube and milk frother should be cleaned in time.

2. It is recommended to use a high cup to prevent the frothed milk from splashing.

(1) Remove the silicone tube and rinse it with tap water.

(2) Remove the coffee outlet cover and rinse it with tap water.

(3) Remove the milk frother and rinse it with tap water.

(4) After finish cleaning, replace all the parts well in position.



3. After each use, please repeat the above operation if there is no milk in the milk reservoir.

(1) Rinse the milk reservoir with tap water.

(2) Remove the milk reservoir and rinse it with tap water.

(3) Remove the milk tube and rinse it with tap water.



Brew Latte

1. Place a coffee container under the coffee outlet.

2. Fill the milk reservoir with appropriate amount of cold milk.

NOTES:

(1) It is recommended that the temperature of milk should be 5-10 C, and the protein content of milk should be at least 3%.

(2) The milk filled in the milk reservoir should not exceed the "MAX" mark on the milk reservoir.

3. Insert the milk tube well in position.

4. Remove the silicone tube from the milk reservoir lid and then connect it with the milk frother and milk reservoir lid.

5. Hold and press the Latte " " for at least 0.2 second and the appliance will start to brew latte.

6. After finish brewing latte, the appliance enters into the standby mode automatically.

7. Hold and press the Latte " " for at least 0.1 second again if need to cancel the current function.

NOTES:

1. After each use, if there is still milk in the milk reservoir, please store it in the refrigerator, but the silicone tube and milk frother should be cleaned in time.

2. It is recommended to use a high cup to prevent the frothed milk from splashing.

(1) Remove the silicone tube and rinse it with tap water.

(2) Remove the coffee outlet cover and rinse it with tap water.

(3) Remove the milk frother and rinse it with tap water.

(4) After finish cleaning, replace all the parts well in position.

3. After each use, please repeat the above operation if there is no milk in the milk reservoir.

(1) Rinse the milk reservoir with tap water.

(2) Remove the milk reservoir and rinse it with tap water.

(3) Remove the milk tube and rinse it with tap water.





Make hot water

1. Place a water container under the coffee outlet.

NOTE: The capacity of water container should be more than 120ml.

2. Check and make sure the plug of milk frother is closed well in position.

3. Hold and press the Hot water “” for at least 0.2 second and the appliance will start to make hot water.

4. After finish making hot water, the appliance enters into the standby mode automatically.

5. Hold and press the Hot water “” for at least 0.1 second again if need to cancel the current function.

NOTE: Please do not touch the water container with your hands during making hot water. Please do not use the hot water to prevent from being burnt as there will be still a little hot steam dispensed from the coffee outlet after finish making hot water.

Manual froth

NOTE: After the “Manual froth” function is conducted, the overheating protection mechanism for the boiler will be activated, at that time, if need to conduct the “Hot water” function the appliance should be rested for about 3-5 minutes and then the “Hot water” function can be activated.

1. Place a milk container under the coffee outlet.

NOTE: The capacity of milk container should be more than 160ml.

2. Fill the milk reservoir with appropriate amount of cold milk.

NOTES:

(1) It is recommended that the temperature of milk should be 5-10 °C, and the protein content of milk should be at least 3%.

(2) The milk filled in the milk reservoir should not exceed the “MAX” mark on the milk reservoir.

3. Hold and press the Manual froth “” for at least 0.2 second and the appliance will start to conduct the manual froth function.

4. After finish frothing milk, the appliance enters into the standby mode automatically.

5. Hold and press the Manual froth “” for at least 0.1 second again if need to cancel the current function.



NOTES:

1. After each use, if there is still milk in the milk reservoir, please store it in the refrigerator, but the silicone tube and milk frother should be cleaned in time.

2. It is recommended to use a high cup to prevent the frothed milk from splashing.

- (1) Remove the silicone tube and rinse it with tap water.
- (2) Remove the coffee outlet cover and rinse it with tap water.
- (3) Remove the milk frother and rinse it with tap water.
- (4) After finish cleaning, replace all the parts well in position.

3. After each use, please repeat the above operation if there is no milk in the milk reservoir.

- (1) Rinse the milk reservoir with tap water.
- (2) Remove the milk reservoir and rinse it with tap water.
- (3) Remove the milk tube and rinse it with tap water.



Manual clean

1. Place a water container under the coffee outlet.

2. Hold and press the Manual clean " " for at least 0.2 second and the appliance will start to conduct the manual clean function.

3. After finish cleaning, the appliance enters into the standby mode automatically.



4. Hold and press the Manual clean " " for at least 0.1 second again if need to cancel the current function.



Empty the coffee beans left

NOTE: This function is used for emptying the beans in the bean box.

Please use it carefully to avoid waste.

1. Hold and press the Bean-emptying " " for at least 1 second and the appliance will start to conduct the bean-emptying function. At that time, the indicator of Bean-emptying " " illuminates solidly while other functional indicators turn off.

2. Remove the residue-collection container and empty the ground coffee in it.

3. After finish working, the appliance enters into the standby mode automatically.



4. Hold and press the Bean-emptying " " for at least 0.3 second again if need to cancel the current function.

NOTE: The bean-emptying function only last for 15 seconds each time, please repeat the above operation if there are many coffee beans left in the bean box.







Energy-saving mode

1. Hold and press the Power switch “” for at least 0.2s to and then the appliance enters into the sleep mode. At that time, all the indicators turn off and all the functions are invalid.
2. The appliance will enter into the sleep mode if there is not any operation within 28 minutes. At that time, all the indicators turn off and all the functions are invalid.
3. During sleep mode, hold and press the Power switch “” for at least 0.2 second, then the appliance will conduct self-check, preheat and return to the standby mode.

NOTES:

- (1) When the appliance is powered on continuously, hold and press the Power switch “” for at least 0.2 second to activate the appliance after more than 4 hours, and the auto-clean function of the appliance will be activated.
- (2) If the appliance is powered off, the auto-clean function will be activated after hold and press the Power switch “” for at least 0.2 second.
- (3) Please refer to the section of “Power on and Preheat” for details.

Set the coffee-dispensing amount and milk-dispensing amount

1. Operation for setting the coffee-dispensing amount:

After the coffee dispenses from the appliance, hold and press the selected functional key for 2 seconds, the buzzer beeps and the corresponding indicator of selected functional key flashes, at that time, the appliance enters into the mode for setting the coffee-dispensing amount. As soon as the coffee in the cup reaches the required level, release the selected functional key, then the appliance stops working and the newly-set coffee-dispensing amount is saved. And the range of coffee-dispensing amount is as below:

- (1) **Single-cup Espresso:** 30-100ml
- (2) **Double-cup Espresso:** (30-100ml)*2
- (3) **Americano:** 110-180ml



2. Operation for setting the milk-dispensing amount:

After the milk dispenses from the appliance, hold and press the selected functional key for 2 seconds, the buzzer beeps and the corresponding indicator of selected functional key flashes, at that time, the appliance enters into the mode for setting the milk-dispensing amount. As soon as the milk in the cup reaches the required level, release the selected functional key, the appliance stops working and the newly-set milk-dispensing amount is saved. The operation for setting the milk-dispensing amount is only applicable for the functions of “Cappuccino” and “Latte”. And the range of milk-dispensing amount is as below:

- (1) **Cappuccino: Coffee:** 30-100ml + Milk: 10-40 seconds
- (2) **Latte: Coffee:** 30-100ml + Milk: 10-40 seconds



Factory reset

Hold and press the Single-cup Espresso “” and Double-cup Espresso “” for 2 seconds at the same time, then all the parameters are recovered to the factory default setting.





CLEANING AND MAINTENANCE





CAUTION: Be sure to unplug this appliance before cleaning and let the appliance cool down completely. To protect against electrical shock, do not immerse cord, plug or unit in water or liquid. Please unplug the appliance after each use.

1. Wipe the outer surface of the product with a soft damp cloth to remove stains, but avoid using abrasive cleaning tools as they will scratch the product. Do not use alcohol or solvent cleaners.
2. Water droplets may buildup in the area above the drip plate or countertop during brewing. To control the dripping, wipe off the area with a clean, dry cloth after each use of the product.
3. The brewer, water tank, milk reservoir, drip tray, drip plate, inner drip tray, residue-collection container and door can not be put into the dishwasher for cleaning.
4. The water in the drip plate and drip tray as well as the coffee grounds in the inner drip tray and residue-collection container need to be emptied and they shall be cleaned well.
5. Clean the parts by following the description and operation as below.

Detachable parts	When to clean	How to clean
Residue-collection container	For Single-cup Espresso, Latte and Cappuccino, conduct once every 8 brewing cycles. For Double-cup Espresso, conduct once every 4 brewing cycles. It is recommended to clean it on the same day if it is not used for a long time.	Remove the residue-collection container and empty it, add some cleaning solution and then rinse it under the tap water.
Brewer	For Single-cup Espresso, Latte and Cappuccino, conduct once every 8 brewing cycles. For Double-cup Espresso, conduct once every 4 brewing cycles. It is recommended to clean it on the same day if it is not used for a long time.	Remove the brewer from the coffee machine and rinse it under the tap water.

Water tank	Once every week	Rinse the water tank under the tap water.
Milk reservoir	After every use	Rinse the milk reservoir under the tap water.
Milk frother	After every use	Remove the milk frother from the appliance and rinse it under the tap water.
Drip tray	Empty the drip tray every day and clean it once every week.	Remove the drip tray and add some cleaning solution and then rinse it under the tap water.
Grinder	Clean it once every week	<ol style="list-style-type: none"> 1.Remove the grind setting knob counterclockwise. 2.Remove the internal grinding wheel counterclockwise. 3.Clean the grinding wheel with the cleaning brush and empty the ground coffee at the gap. 4.Clean the grinding chamber with the cleaning brush. 5.Do not install the grinding wheel and install the grind setting knob well in position again. 6.Press the button of grinder. 7.Let the grinder keep running to remove the remaining powder in the grinding chamber (please repeat the operation of Step 3 and 4 if there is coffee powder left.) 8.Remove the grind setting knob counterclockwise. 9.Install the grinding wheel clockwise. 10.Install the grind setting knob clockwise, and the cleaning is completed.

Non-detachable parts	When to clean	How to clean
Powder-dispensing channel	Check it once a week	<p>Method 1:</p> <ol style="list-style-type: none"> 1. Hold and press the "Bean-emptying" key  and "Single-cup Espresso" key  for 2 seconds at the same time, their corresponding indicators flash and the door is opened. 2. Open the door and loosen the ground coffee in the power-dispensing channel by a toothpick, and then close the door when there is ground coffee falls down. 3. Hold and press the "Bean-emptying" key  and "Single-cup Espresso" key  at the same time again for at least 0.3 second, then their corresponding indicators extinguish and the door is closed. <p>Method 2:</p> <ol style="list-style-type: none"> 1. If there are few coffee beans remained in the bean box, hold and press the "Bean-emptying" key  for at least one second to make the appliance keep working until the ground coffee blocked in the power-dispensing channel are emptied, and then the appliance goes back to the normal working status. <p>NOTE: If the ground coffee become finer obviously during the use of the appliance, or the coffee pack become smaller after finish brewing, please check the powder-dispensing channel for any powder blockage, and the powder-dispensing channel should be cleaned once every week.</p>
Brewing base	Check it once a week	Clean the coffee residue around the brewing base with a brush.

<p>Brewing system bracket</p>	<p>Check it once a week</p>	<ol style="list-style-type: none"> 1. When the appliance is powered on, hold and press Manual Clean key  and Double-cup Espresso  for 1 second to enter into the mode for cleaning the dead corner of brewer. 2. After enter into the brewer-cleaning function, the brewer moves to the bottom. 3. After the brewing door is opened (the appliance stays at the safe protection state), the dead corner of brewer can be cleaned. 4. After finish cleaning, close the brewing door. 5. Hold and press Manual Clean key  and Double-cup Espresso  for 1 second to exit from the cleaning function.
-------------------------------	-----------------------------	--

Clean the residue-collection container

- 1.Open the door.
- 2.Remove the residue-collection container.
- 3.Empty the coffee puck in the residue-collection container.
- 4.Rinse the residue-collection container under the tap water.
- 5.Install the residual-collection container into the appliance.
- 6.Close the door and the cleaning is completed.

Clean the brewer

- 1.Open the door.
- 2.Remove the brewer.
- 3.Rinse the brewer under the tap water.
- 4.Install the brewer into the appliance.
- 5.Close the door and the cleaning is completed.

Clean the water tank

- 1.Remove the water tank from the coffee machine.
- 2.Rinse the water tank under the tap water.

Clean the milk reservoir

- 1.Remove the connecting tube from the appliance after every use.
- 2.Rinse the milk reservoir under the tap water.
- 3.Store the milk reservoir well after cleaning.

Clean the milk frother

- 1.Remove the coffee outlet cover.
- 2.Remove the milk frother from the coffee outlet.
- 3.Rinse the milk frother under the tap water.
- 4.Install the milk frother well, make sure the part with plug should be kept on the left .
- 5.Install the coffee outlet cover, and the cleaning is completed.





Clean the drip tray

- 1.Remove the drip tray.
- 2.Add some cleaning solution and rinse the drip tray under the tap water.
- 3.After cleaning, install the drip tray again.

Clean the grinder





- 1.Remove the grind setting knob counterclockwise
- 2.Remove the internal grinding wheel counterclockwise.
- 3.Clean the grinding wheel with the cleaning brush and empty the ground coffee at the gap.
- 4.Clean the grinding chamber with the cleaning brush.
- 5.Do not install the grinding wheel and install the grind setting knob well in position again.
- 6.Press the button of grinder.
- 7.Let the grinder keep running to remove the remaining powder in the grinding chamber (please repeat the operation of Step 3 and 4 if there is coffee powder left.)
- 8.Remove the grind setting knob counterclockwise.
- 9.Install the grinding wheel clockwise.
- 10.Install the grind setting knob clockwise, and the cleaning is completed.

Clean the brewing system bracket

- 1.When the appliance is powered on, hold and press Manual Clean key  and Double-cup Espresso  for 1 second to center into the mode for cleaning the dead corner of brewer.
- 2.After enter into the brewer-cleaning function, the brewer moves to the bottom.
- 3.After the brewing door is opened (the appliance stays at the safe protection state), the dead corner of brewer can be cleaned.
- 4.After finish cleaning, close the brewing door.
- 5.Hold and press Manual Clean key  and Double-cup Espresso  for 1 second to exit from the cleaning function.

Clean the powder-dispensing channel

Method 1:

- 1.Hold and press the "Bean-emptying" key  and "Single-cup Espresso" key  for 0.2 seconds at the same time, their corresponding indicators flash and the door is opened.
- 2.Open the door and loosen the ground coffee in the power-dispensing channel by the cleaning brush, and then close the door when there is ground coffee falls down.
- 3.Hold and press the "Bean-emptying" key  and "Single-cup Espresso" key  at the same time again for at least 0.1 second, then their corresponding indicators extinguish and the door is closed.

Method 2:

- 1.If there are few coffee beans remained in the bean box, hold and press the "Bean-emptying" key  for at least one second to make the appliance keep working until the ground coffee blocked in the power-dispensing channel are emptied, and then the appliance goes back to the normal working status.

NOTE: If the ground coffee become finer obviously during the use of the appliance, or the coffee pack become smaller after finish brewing, please check the powder-dispensing channel for any powder blockage, and the powder-dispensing channel should be cleaned once every week.









Clean the brewing system and frothing system manually

- 1.Fill the water tank with appropriate amount of room-temperature water, which shall not exceed the MAX water level, and then close the water tank lid.
- 2.Install the brewer assembly into the brewing chamber of appliance and then close the door of brewing chamber.
- 3.Put the drip plate on the drip tray and then place a container on the drip plate.
- 4.Activate the "Manual clean" function to clean the brewing system and milk-frothing channel. After finish preheating, all the functional indicators illuminate solidly and the appliance enters into the standby mode. Hold and press the Manual clean "  " for at least 0.2 second, the appliance will enter into the manual clean process.

- NOTE: If need to clean the milk-frothing channel, please install the milk reservoir and fill the milk reservoir with some clean water instead of milk. If do not need to clean the milk-frothing channel, please close the plug of milk frother well in position.
- 5.After finish cleaning, the appliance enters into the standby mode automatically.
 - 6.Open the door of brewing chamber and clean the coffee grounds in the brewing system with the cleaning brush.



Remove the mineral deposits









- 1.The appliance needs to be descaled when the indicators of Hot water "  " and Manual clean "  " will flash at the same time.
- 2.Fill the water tank with water and descaler to the MAX level as indicated on the water tank (the scale of water and descaler is 4:1, the detail refers to the instruction of descaler. Please use "household descaler"), you may also use the citric acid instead of the descaler (one hundred parts of water and three parts of citric acid).
- 3.Put a container on the drip plate.
- 4.Hold and press Hot water "  " and Manual clean "  " for 1 second at the same time, and the appliance enters into the descaling procedure.
- 5.The whole descaling procedure lasts for about 10 minutes. The eight (8) functional indicators flash slowly from left to right.
- 6.After the descaling is completed, the indicators of Hot water "  " and Manual clean "  " stop flashing.









NOTE: The number of coffee-brewing cycle will be zeroed and recounted after a complete descaling is finished. And the descaling prompt will be occurred when the appliance has brewed 500 cycles of coffee cumulatively again.

HINTS FOR GREAT-TASTING COFFEE





1. A clean coffee machine is essential for making tasty coffee. It is necessary to clean the coffee machine as specified in the "**CLEANING AND MAINTENANCE**" section regularly. Always use fresh, room-temperature water when brewing coffee.
2. Store unused ground coffee at a cool and dry place. After a new bag of ground coffee is unpacked, reseal it tightly and store it in a refrigerator to maintain its freshness.

TROUBLESHOOTING

Problem	Cause	Solution
The Refill indicator "  " flashes.	The water tank is lack of water.	1. Refill the water tank with water. 2. Please contact the service department if the problem can not be solved.
The Warning indicator "  " flashes.	The grind setting knob and door are not installed well in position.	1. Install the grind setting knob and door in position. 2. Please contact the service department if the problem can not be solved.
The Warning indicator "  " illuminates solidly.	The brewer or inner drip tray is not installed well in position.	1. Install the brewer or inner drip tray well in position. 2. Please contact the service department if the problem can not be solved.
The No bean indicator "  " illuminates solidly.	The bean box is lack of coffee beans.	Fill the bean box with coffee beans and then run the coffee machine to brew coffee, then the no-bean warning can be canceled.
The Residue full indicator "  " illuminates solidly.	The residue-collection container needs to be cleaned.	1. Remove the residue-collection container and inner drip tray for cleaning, after 2 seconds, the "Residue full indicator" "  " turns off. 2. Please contact the service department if the problem can not be solved.
The Brewer cleaning indicator "  " illuminates solidly.	The brewer needs to be cleaned.	1. Remove the brewer for cleaning, after 2 seconds, the "Brewer cleaning indicator" "  " turns off. 2. Please contact the service department if the problem can not be solved.

<p>The Single-cup Espresso “” and Warning indicator “” flash at the same time.</p>	<p>The grinding motor does not work normally.</p>	<ol style="list-style-type: none"> 1. Turn off the appliance and restart it. 2. Please contact the service department if the problem can not be solved.
<p>The No bean indicator “” and Warning indicator “” flash at the same time.</p>	<p>It means that the appliance has performed the bean-grinding for 16 cycles continuously, and the time for each grinding is less than 5 minutes. And then the grinding system will be forced to be cooled down for 5 minutes, at that time, all the functions are invalid.</p>	<ol style="list-style-type: none"> 1. The appliance will rest for 5 minutes or turn off the appliance and restart it. 2. Please contact the service department if the problem can not be solved.
<p>The indicator of Hot water “” and Warning indicator “” flash at the same time.</p>	<p>The flow meter has no signal and the water-dispensing is abnormal.</p>	<ol style="list-style-type: none"> 1. Fill the water tank with water. 2. Please contact the service department if the problem can not be solved.
<p>The indicator of Latte “” and Warning indicator “” flash at the same time.</p>	<p>The Hall element has no signal and the brewing motor does not work normally.</p>	<ol style="list-style-type: none"> 1. Turn off the appliance and restart it. 2. Please contact the service department if the problem can not be solved.
<p>The crema is not rich.</p>	<p>The ground coffee is too coarse.</p>	<p>Turn the grind setting knob clockwise to select the proper setting.</p>
	<p>The type of coffee bean used is wrong.</p>	<p>Use the coffee beans which are suitable for brewing espresso.</p>

Coffee comes out slowly or comes out drip by drip.	The ground coffee is too fine.	Turn the grind setting knob anticlockwise to select the proper setting.
Coffee does not come out of the coffee outlet.	The coffee outlet is blocked.	Clean the coffee outlet with a toothpick.
The machine can not be activated.	The power plug has not been connected well in position.	Connect the power plug with the main power supply of machine.
	The power source is not connected well.	Connect the power source of the machine.
	The On/Off button is not turned on.	Turn on the On/Off button .
The brewer can not be removed.	The machine is not turned off correctly. The brewer is blocked.	Turn off the machine and then turn it on again to make the brewer be reset. Please contact the after-sales department if the problem can not be solved. Contact the after-sales department.
The milk foam is too large or sprays from the milk outlet.	The milk is not cold enough or the milk used is not suitable for being frothed.	It is recommended that the temperature of milk should be 5-10 °C, and the protein content of milk should be at least 3%.
	The milk frother is too dirty.	Clean the milk frother.
Both the residue full indicator and brewer cleaning indicator illuminate.	You may empty the residue-collection container and clean the brewer when the coffee machine is turned off.	Please always empty the residue-collection container and clean the brewer when the coffee machine is turned on. And install them again after waiting for at least 3 seconds.

<p>The residue-collection container is not full but the machine prompts you to empty the residue-collection container or clean the brewer.</p>	<p>The counter is not reset after emptying the residue-collection container or cleaning the brewer.</p>	<p>After replacing the residue-collection container or the brewer, always wait for about 3 seconds to make the counter be reset to zero. Always empty the residue-collection container and clean the brewer when the coffee machine is turned on. The counter will not be reset if the residue-collection container is emptied or the brewer is cleaned when the coffee machine is turned off.</p>
<p>The coffee machine can grind coffee beans but there is no coffee come out.</p>	<p>Please check the deeply-roasted coffee beans for the oil on the surface. The powder-dispensing channel will be blocked if the coffee beans are dampened or there is too much oil on the surface.</p>	<ol style="list-style-type: none"> 1. Hold and press the "Bean-emptying" key " " and "Single-cup Espresso" key " " for 2 seconds at the same time, the door is opened, and their corresponding indicators flash. 2. After the door is opened, loosen the ground coffee in the power-dispensing channel by the cleaning brush, and then close the door when there is ground coffee falls down. 3. And then hold and press the "Bean-emptying" key " " and "Single-cup Espresso" key " " for at least 0.3 second again, and their corresponding indicators extinguish and the door is closed.
<p>The coffee machine makes large noise.</p>	<p>It is normal that the coffee machine makes noise during operation.</p>	<p>If the coffee machine starts to make another kind of noise, please lubricate the brewing system and contact the after-sales department.</p>

ENVIRONMENT FRIENDLY DISPOSAL



You can help protect the environment!
Please remember to respect the local regulations: hand in the non-working electrical equipments to an appropriate waste disposal center.

WARRANTY POLICY

1-Year Limited Warranty

Toll-Free Call: 1-833-632-0897 Mon to Fri, 9AM - 6PM (ET)

Email: support@homyd.com

Thank you for choosing our products. We provide a 1-Year Limited Warranty for items purchased through our official channels. Please kindly note that this warranty is for the original purchaser and is non-transferable. If you purchase from an unauthorized seller, please get in touch with them directly.

We are committed to ensuring that our products are free from defects in materials and workmanship for one year from the date of purchase, as long as they are used under normal household conditions and maintained according to the User Manual. **Please note that certain conditions and exclusions apply:**

Should you find any defects in the original product or its non-wearable parts, we will be happy to repair or replace the item within one year of purchase. If a replacement is necessary, the warranty period will continue from the original purchase date. Please be aware that normal wear and tear, or damage due to mishandling, accidents, or failure to follow instructions, are not covered. However, replacement parts are available for purchase. Feel free to contact us for more information.

Please also note that this warranty does not cover damage caused by exposure to liquids or foreign materials, unauthorized repairs or modifications, or use in commercial or non-household environments (unless specified for commercial use).

If you encounter any issues with your product, we are here to help. You can reach us by phone at **1-833-632-0897** or email us at **support@homyd.com**. For certain product categories, we also offer the option to upgrade your warranty to our VIP service.

Our friendly phone support team is available from **Monday to Friday, 9 AM - 6 PM (ET)**.- To assist you more efficiently, please have your product with you when you call. Besides, we aim to respond to emails within 24 business hours. If you don't receive a reply within this timeframe after sending us an email, kindly check your spam folder to ensure you don't miss our response.

In addition to the one-year warranty, we also offer lifetime technical support. After the warranty period, service is still available at an additional cost. Please don't hesitate to contact us with any questions or concerns.

SKU: CM003-20SI-USZX

