



# ELECTRIC COOKTOP USER INSTRUCTIONS

THANK YOU for purchasing this high-quality product. Register your range at [www.whirlpool.com](http://www.whirlpool.com). In Canada, register your range at [www.whirlpool.ca](http://www.whirlpool.ca). In Mexico, register your range at [www.whirlpool.mx](http://www.whirlpool.mx)

For future reference, please make a note of your product model and serial numbers. These can be located on the serial plates. The serial plates are located behind the control panel. You may view them by rotating the serial plates up.

Model Number \_\_\_\_\_ Serial Number \_\_\_\_\_

Para una versión de estas instrucciones en español, visite [www.whirlpool.com](http://www.whirlpool.com).

Deberá tener los números de modelo y serie, que se pueden encontrar en las placas de serie detrás del panel de control. Los puede ver al rotar hacia arriba las placas de serie.

## Table of Contents

<b>COOKTOP SAFETY</b> .....	<b>2</b>
<b>PARTS AND FEATURES-TOUCH-ACTIVATED CONTROLS</b> .....	<b>4</b>
<b>COOKTOP CONTROLS – ELECTRONIC TOUCH CONTROLS</b> .....	<b>5</b>
Cooktop Controls.....	5
Dual/Triple Element .....	6
Control Lock.....	7
Kitchen Timer .....	7
<b>PARTS AND FEATURES - KNOB CONTROLS</b> .....	<b>8</b>
<b>COOKTOP CONTROLS - KNOB CONTROLS</b> .....	<b>9</b>
Dual/Triple-Circuit Element (on some models) .....	9
<b>COOKTOP USE</b> .....	<b>10</b>
Ceramic Glass (on some models).....	10
Home Canning .....	11
Cookware .....	11
<b>COOKTOP CARE</b> .....	<b>11</b>
General Cleaning.....	11
<b>TROUBLESHOOTING</b> .....	<b>13</b>
<b>ASSISTANCE OR SERVICE</b> .....	<b>14</b>
In the U.S.A. ....	14
Accessories .....	14
In Canada .....	14
In Mexico.....	14

# COOKTOP SAFETY

## Your safety and the safety of others are very important.

We have provided many important safety messages in this manual and on your appliance. Always read and obey all safety messages.



This is the safety alert symbol.

This symbol alerts you to potential hazards that can kill or hurt you and others.

All safety messages will follow the safety alert symbol and either the word "DANGER" or "WARNING."

These words mean:

 **DANGER**

**You can be killed or seriously injured if you don't immediately follow instructions.**

 **WARNING**

**You can be killed or seriously injured if you don't follow instructions.**

All safety messages will tell you what the potential hazard is, tell you how to reduce the chance of injury, and tell you what can happen if the instructions are not followed.

State of California Proposition 65 Warnings:

**WARNING:** This product contains one or more chemicals known to the State of California to cause cancer.

**WARNING:** This product contains one or more chemicals known to the State of California to cause birth defects or other reproductive harm.

# IMPORTANT SAFETY INSTRUCTIONS

**WARNING:** To reduce the risk of fire, electrical shock, injury to persons, or damage when using the cooktop, follow basic precautions, including the following:

- **CAUTION:** Do not store items of interest to children in cabinets above a cooktop – Children climbing on the cooktop to reach items could be seriously injured.
- Proper Installation – Be sure your cooktop is properly installed and grounded by a qualified technician.
- Never Use Your Cooktop for Warming or Heating the Room.
- Do Not Leave Children Alone – Children should not be left alone or unattended in area where cooktop is in use. They should never be allowed to sit or stand on any part of the cooktop.
- This appliance is not intended for use by people (including children) whose physical, sensory or mental capacities are different or impaired or who lack the necessary experience or knowledge/expertise to do so, unless such persons are supervised or are trained to operate the appliance by a person who accepts responsibility for their safety.
- Wear Proper Apparel – Loose-fitting or hanging garments should never be worn while using the cooktop.
- User Servicing – Do not repair or replace any part of the cooktop unless specifically recommended in the manual. All other servicing should be referred to a qualified technician.
- Storage on Cooktop – Flammable materials should not be stored near surface units.
- **WARNING:** Failing to supervise an electric grill when cooking on it with oil or fat is dangerous and constitutes a fire hazard.
- Do Not Use Water on Grease Fires – Smother fire or flame or use dry chemical or foam-type extinguisher.
- Use Only Dry Potholders – Moist or damp potholders on hot surfaces may result in burns from steam. Do not let potholder touch hot heating elements. Do not use a towel or other bulky cloth.
- **DO NOT TOUCH SURFACE UNITS OR AREAS NEAR UNITS** – Surface units may be hot even though they are dark in color. Areas near surface units may become hot enough to cause burns. During and after use, do not touch, or let clothing or other flammable materials contact surface units or areas near units until they have had sufficient time to cool. Among those areas are the cooktop and surfaces facing the cooktop.
- Use Proper Pan Size – This cooktop is equipped with one or more surface units of different size. Select utensils having flat bottoms large enough to cover the surface unit heating element. The use of undersized utensils will expose a portion of the heating element to direct contact and may result in ignition of clothing. Proper relationship of utensil to burner will also improve efficiency.

- Never Leave Surface Units Unattended at High Heat Settings – Boilover causes smoking and greasy spillovers that may ignite.
- **CAUTION:** The cooking process should be supervised. Short cooking periods require constant supervision.
- Glazed Cooking Utensils – Only certain types of glass, glass/ceramic, ceramic, earthenware, or other glazed utensils are suitable for cooktop service without breaking due to the sudden change in temperature.
- Utensil Handles Should Be Turned Inward and Not Extend Over Adjacent Surface Units – To reduce the risk of burns, ignition of flammable materials, and spillage due to unintentional contact with the utensil, the handle of a utensil should be positioned so that it is turned inward, and does not extend over adjacent surface units.
- Metal objects, such as knives, forks, spoons and lids should not be left on the grill's cooking surface as they may get hot.
- Do Not Cook on Broken Cooktop – If cooktop should break, cleaning solutions and spillovers may penetrate the broken cooktop and create a risk of electric shock. Contact a qualified technician immediately. Turn off the device to avoid the possibility of electric shock.
- If the power supply cord gets damaged, have it replaced by the manufacturer, the latter's service agent or by qualified personnel in order to avoid danger.
- Clean Cooktop With Caution – If a wet sponge or cloth is used to wipe spills on a hot cooking area, be careful to avoid steam burn. Some cleaners can produce noxious fumes if applied to a hot surface.
- The device is not designed to be started up by an external timer or by a separate remote control system.

## For units with ventilating hood

- Clean Ventilating Hoods Frequently – Grease should not be allowed to accumulate on hood or filter.
- When flaming foods under the hood, turn the fan on.

## For units with coil elements

- Make Sure Reflector Pans or Drip Bowls Are in Place – Absence of these pans or bowls during cooking may subject wiring or components underneath to damage.
- Protective Liners – Do not use aluminum foil to line surface unit drip bowls, except as suggested in the manual. Improper installation of these liners may result in a risk of electric shock, or fire.
- Do Not Soak Removable Heating Elements - Heating elements should never be immersed in water.

## SAVE THESE INSTRUCTIONS

# PARTS AND FEATURES-TOUCH-ACTIVATED CONTROLS

This manual covers different models. The cooktop you have purchased may have some or all of the items listed. The locations and appearances of the features shown here may not match those of your model.

## Control Panels

**Model WCE97US0H (30" [76.2 cm]),  
Touch-Activated Electronic Control Models**

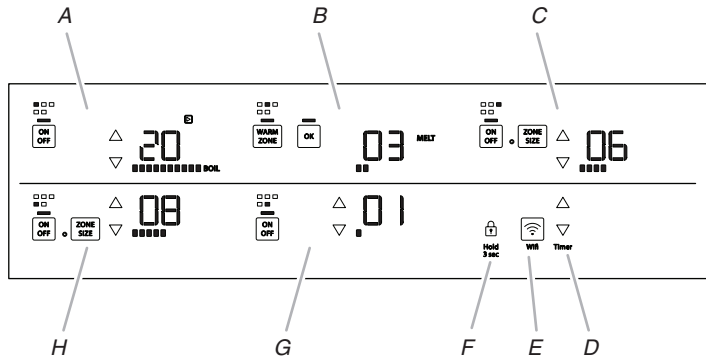

- A. Left rear touch control
- B. Center rear touch control (warm zone)
- C. Right rear touch control (dual element)
- D. Timer touch control
- E. Wifi touch control
- F. Control lock indicator (hold 3 seconds)
- G. Center front touch control
- H. Left front touch control

**Model WCE97US6H (36" [91.4 cm])  
Touch-Activated Electronic Control Models**

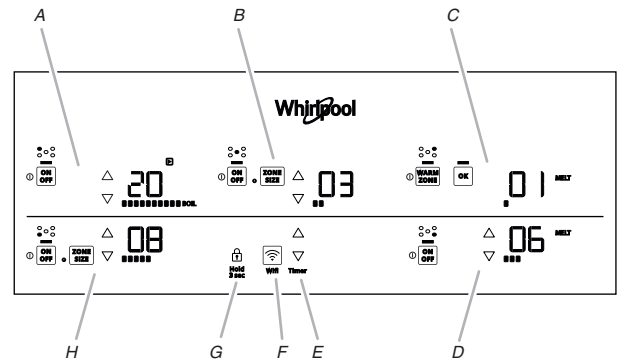

- A. Left rear touch control
- B. Center touch control (triple element)
- C. Right rear touch control (warm zone)
- D. Right front touch control
- E. Timer touch control
- F. Wifi touch control
- G. Control lock indicator (hold 3 seconds)
- H. Left front touch control (dual element)

## Cooktop

**30" (76.2 cm) Model WCE97US0H Touch-Activated Electronic Control Model shown**

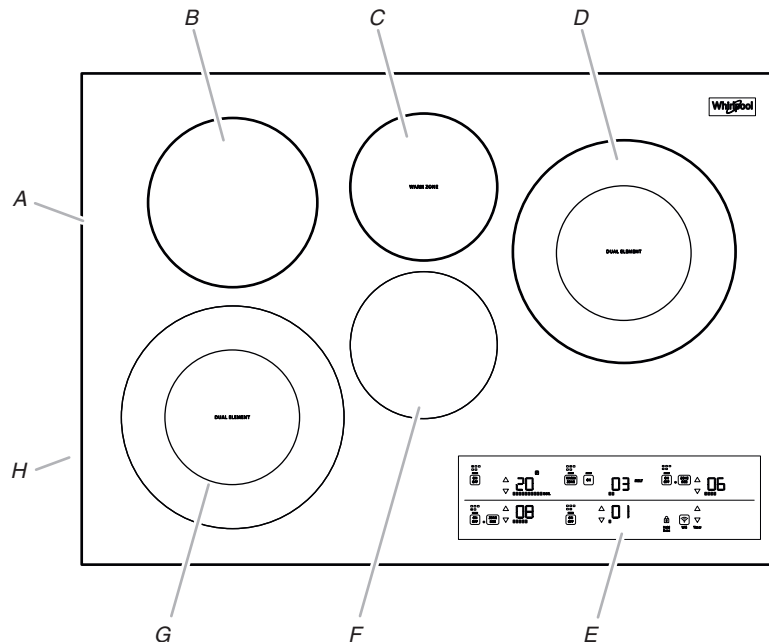

- A. Ceramic glass cooktop
- B. 6" (15.2 cm) single element
- C. Center rear warming zone
- D. 10"/6" (25.4 cm/15.2 cm) dual element
- E. Control panel
- F. 6" (15.2 cm) single element
- G. 10"/6" (25.4 cm/15.2 cm) dual element
- H. Model and serial number plate (located underneath cooktop on metal cabinet)

36" (91.4 cm) Model WCE97US6H Touch-Activated Electronic Control Model shown

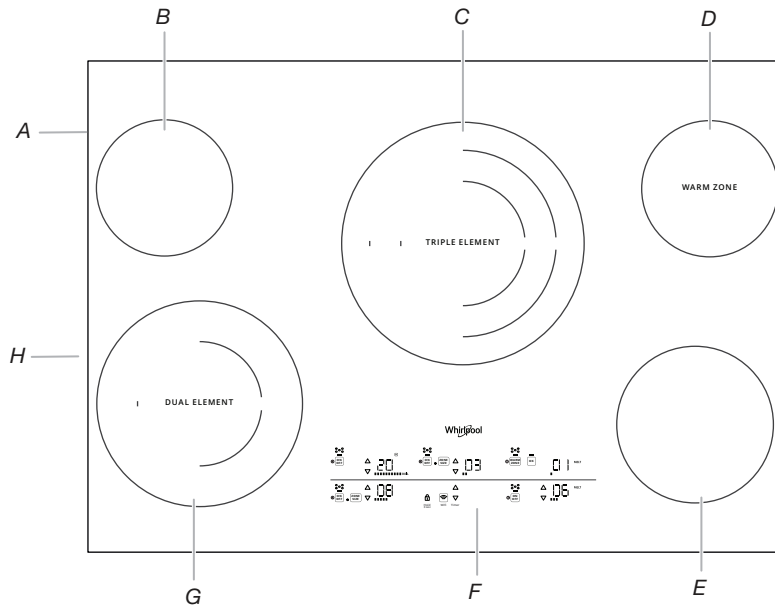

- A. Ceramic glass cooktop
- B. 6" (15.2 cm) single element
- C. 12"/10"/6" (30.5 cm/25.4 cm/15.2 cm) triple element
- D. Right rear warming zone

- E. 6" (15.2 cm) single element
- F. Control panel
- G. 10"/6" (25.4 cm/15.2 cm) dual element
- H. Model and serial number plate (located underneath cooktop on metal cabinet)

# COOKTOP CONTROLS – ELECTRONIC TOUCH CONTROLS

## Cooktop Controls

### Wi-Fi Connectivity

- **Connect to Network:** Download the Whirlpool® app from the app store on your mobile phone. See the Connectivity Setup sheet for more detailed instructions.
- **SAID Code:** The SAID code is used to sync a smart device with your appliance.  
The SAID code plate is located on the metal cabinet underneath the cooktop. See the following illustration.

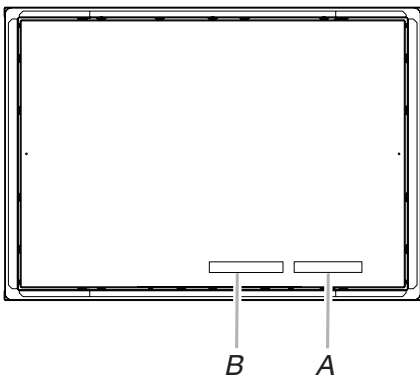

- A. Model/serial number plate
- B. SAID code for Wi-Fi connection

- **MAC Address:** MAC Address is displayed for the Wi-Fi module.

- **Wi-Fi Radio:** Turn Wi-Fi on or off.

**! WARNING**

**Fire Hazard**

**Turn off all controls when done cooking.**

**Failure to do so can result in death or fire.**

The electronic touch controls offer a variety of heat settings for optimal cooking results.

For maximum element operation, all cooktop electronic touch controls can be set to High when bringing liquids to a rapid boil. When the cooktop is turned on or after power is restored to the cooktop after a power failure, all temperature setting lights will glow for 10-15 seconds. After the lights go off, the cooktop is ready to use.

### To Use:

1. Touch ON/OFF for the desired element.
2. Touch the UP or DOWN keypad to select the power level.

**NOTE:** Press and hold the UP or DOWN keypad for a few seconds to quickly scroll through the power level. If a power level is not selected within approximately 10 seconds, the element will not turn on.

- To change the power level while cooking, select a power level with the UP or DOWN keypad.
- When finished cooking, touch ON/OFF for the desired element to turn off surface cooking area(s) individually or touch OFF to turn off all surface cooking areas at once.

Use the following chart as a guide when setting heat levels.

Setting	Recommended Use
<b>High</b> 20 BOIL	<ul style="list-style-type: none"> <li>Start food cooking.</li> <li>Bring liquid to a boil.</li> </ul>
<b>Medium High</b> 17-19	<ul style="list-style-type: none"> <li>Hold a rapid boil.</li> <li>Quickly brown or sear food.</li> </ul>
<b>Medium</b> 10-16	<ul style="list-style-type: none"> <li>Maintain a slow boil.</li> <li>Fry or sauté foods.</li> </ul>
<b>Medium Low</b> 04-09	<ul style="list-style-type: none"> <li>Cook soups, sauces, and gravies.</li> <li>Stew or steam food.</li> </ul>
<b>Low</b> 03 SIMMER	<ul style="list-style-type: none"> <li>Provide lowest simmer/heat setting.</li> <li>Simmer (range of simmer temperatures).</li> </ul>
<b>Keep Warm</b> 02 K. WARM	<ul style="list-style-type: none"> <li>Keep cooked foods warm.</li> </ul>
<b>Melt</b> 01 MELT	<ul style="list-style-type: none"> <li>Melt chocolate and butter.</li> </ul>
<b>Dual/Triple Elements</b>	<ul style="list-style-type: none"> <li>Home canning</li> <li>Large-diameter cookware</li> <li>Large quantities of food</li> </ul>

**REMEMBER:** When cooktop is in use, the entire cooktop area may become hot.

### Hot Surface Indicator Lights

An “H” will appear in the surface cooking area display as long as any surface cooking area is too hot to touch, even after the surface cooking area(s) is turned off.

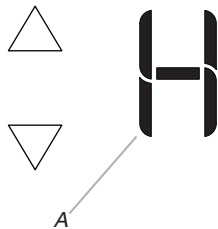

A. Hot surface indicator

### Cooktop On Indicator Light

The cooktop has a cooktop on indicator light. The light will glow when any of the elements are on.

The element display will show the current power level when that element is on and a power level is selected.

## Dual/Triple Element

The dual and triple elements offer flexibility depending on the size of the cookware. Single size can be used in the same way as a regular element. The dual and triple sizes combine single, dual, and outer elements and are recommended for larger cookware, large quantities of food, and home canning.

### Triple Element (on some models)

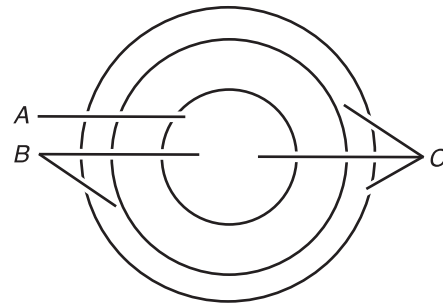

A. Single size  
B. Dual size  
C. Triple size

### Dual Element

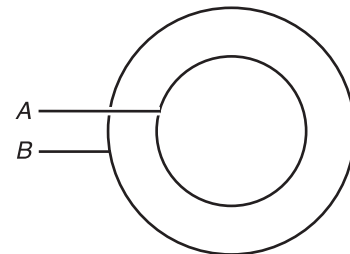

A. Single element  
B. Dual element

### To Use Dual and Triple:

- When On/Off is touched, all heating zones for the selected element will be active. To reduce the number of heating zones being used, touch ZONE SIZE. One, two, or three lights will glow to indicate the number of burner zones being used. One of the lights will blink.

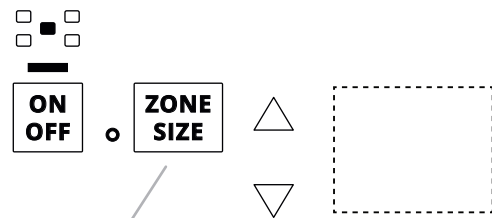

A. Zone size

- Touch the UP or DOWN keypad to select the power level. A tone will sound each time a keypad is touched.
 

**NOTE:** Press and hold UP or DOWN keypad for a few seconds to quickly scroll through the power level. If a power level is not selected within approximately 10 seconds, the element will not turn on.
- To change the power level while cooking, touch the UP or DOWN keypad to select a new power level.
 

**NOTE:** If the power level is at the minimum power setting, press DOWN to jump to the maximum setting.
- To change the heating zones being used while cooking, touch ZONE SIZE.
- When finished cooking, touch ON/OFF for the desired element to turn off the surface cooking area.

---

## Control Lock

The Control Lock cooktop control avoids unintended use of the surface cooking areas. When the cooktop is locked out, the surface cooking areas cannot be turned on by the cooktop touch controls.

**To Lock Cooktop:** Touch and hold CONTROL LOCK HOLD 3 SEC for 3 seconds. After 3 seconds, CONTROL LOCK HOLD 3 SEC will glow red, indicating that the cooktop controls are in the lockout position.

**To Unlock Cooktop:** Touch and hold CONTROL LOCK HOLD 3 SEC for 3 seconds.

---

## Kitchen Timer

The cooktop has a Kitchen Timer. The Timer can be set in minutes up to 99 minutes.

### To Use Kitchen Timer:

1. Press UP button to select the desired time.

**NOTE:** Press and hold the UP or DOWN buttons for a few seconds to quickly scroll through the time.

2. After releasing the button, the timer countdown will start in 3 seconds.

3. If needed to adjust the time, press UP button to increase the time or DOWN button to decrease the time.

4. When countdown is over, timer tone will sound. The display will indicate 00 and chime will play every 30 seconds until 5 minutes pass or DOWN button is pressed. The display will be blank.

### To Cancel:

Press DOWN button until display shows "00".

# PARTS AND FEATURES - KNOB CONTROLS

This manual covers different models. The cooktop you have purchased may have some or all of the items listed. The locations and appearances of the features shown here may not match those of your model.

## Control Panels

WCE55US4H (24" [60.96 cm])  
 WCE55US0H (30" [76.2 cm])  
 WCE77US0H (30" [76.2 cm])

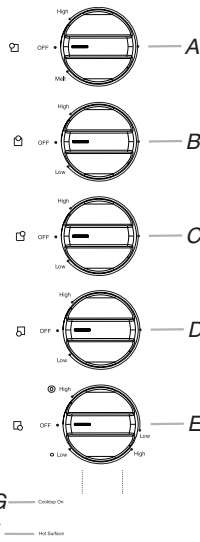

WCE55US6H (36" [91.4 cm])  
 WCE77US6H (36" [91.4 cm])

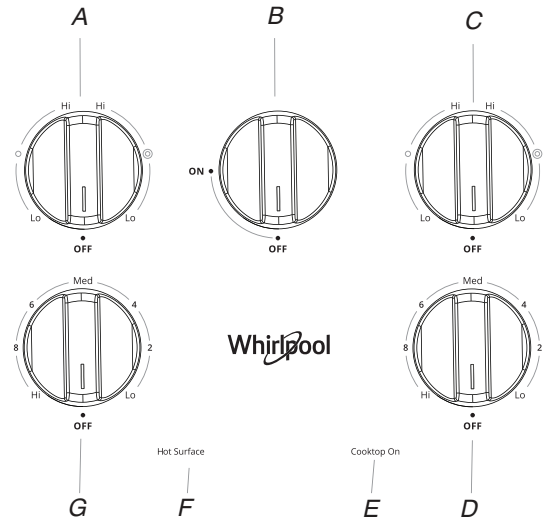

- A. Left rear control knob
- B. Center rear control knob
- C. Right rear control knob
- D. Left front control knob

- E. Right front control knob (dual-zone burner)
- F. Hot surface indicator light
- G. Cooktop on indicator light

- A. Left rear control knob (with dual-size element)
- B. Center rear control knob (Warm zone)
- C. Right rear control knob (with dual-size element)

- D. Right front control knob
- E. Cooktop on indicator light
- F. Hot surface indicator light
- G. Left front control knob

## Cooktops

WCE55US6H (36" [91.4 cm])  
 WCE77US6H (36" [91.4 cm])

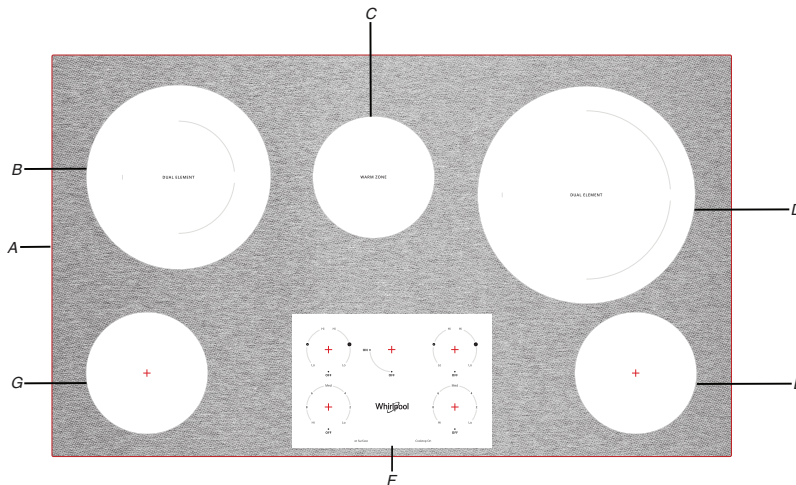

### Ceramic glass Cooktop

- A. Ceramic glass cooktop
- B. Left rear surface cooking area (with dual size element)
- C. Center rear warm zone
- D. Right rear surface cooking area (with dual size element)
- E. Right front single surface cooking area
- F. Control panel
- G. Left front single surface cooking area

# COOKTOP CONTROLS - KNOB CONTROLS

## ⚠ WARNING



### Fire Hazard

Turn off all controls when done cooking.

Failure to do so can result in death or fire.

The controls can be set to anywhere between Lo and Hi.

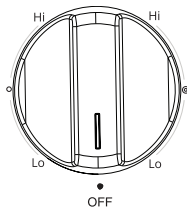

### To Use:

1. Push in and turn knob to desired heat setting.  
Use the following chart as a guide when setting heat levels.

SETTING	RECOMMENDED USE
<b>High</b>	<ul style="list-style-type: none"> <li>Start food cooking.</li> <li>Bring liquid to a boil.</li> </ul>
<b>Medium High</b>	<ul style="list-style-type: none"> <li>Hold a rapid boil.</li> <li>Quickly brown or sear food.</li> </ul>
<b>Medium</b>	<ul style="list-style-type: none"> <li>Maintain a slow boil.</li> <li>Fry or sauté foods.</li> <li>Cook soups, sauces and gravies.</li> <li>High simmer or simmer without lids.</li> </ul>
<b>Medium Low</b>	<ul style="list-style-type: none"> <li>Stew or steam food.</li> <li>Simmer.</li> </ul>
<b>Low</b>	<ul style="list-style-type: none"> <li>Keep food warm.</li> <li>Melt chocolate or butter.</li> <li>Low simmer using lids.</li> </ul>
<b>Dual/Triple Elements (on some models)</b>	<ul style="list-style-type: none"> <li>Home canning.</li> <li>Large-diameter cookware.</li> <li>Large quantities of food.</li> </ul>

**REMEMBER:** When cooktop is in use, the entire cooktop area may become hot.

### Hot Surface Indicator Lights (on Standard Control models)

The Hot Surface Indicator Lights will glow as long as any surface cooking area is too hot to touch, even after the surface cooking area(s) is turned off.



Hot Surface

If the cooktop is on when a power failure occurs, the Hot Surface Indicator Lights will remain on after the power is restored to the cooktop. They will remain on until the cooktop has cooled completely.

### Power Light

Each cooktop has a Power On light. The light will glow when any burner is on.

## Dual/Triple-Circuit Element (on some models)

The dual-size and triple-size elements offer flexibility depending on the size of the cookware. Single size can be used in the same way as a regular element. The dual and triple sizes combine single, dual and outer element and are recommended for larger cookware, large quantities of food, and home canning.

### Triple Element (on some models)

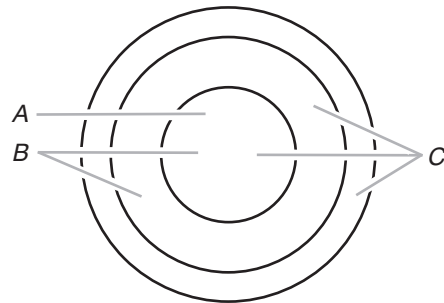

A. Single size  
B. Dual size  
C. Triple size

### Dual Element

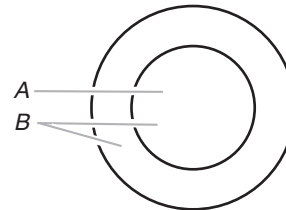

A. Single size  
B. Dual size

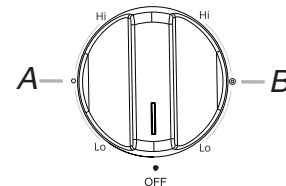

A. Single zone  
B. Dual zone

### To Use SINGLE:

1. Push in and turn knob from the OFF position to the SINGLE zone anywhere between Lo and Hi.
2. Turn knob to OFF when finished.

### To Use DUAL and TRIPLE:

1. Push in and turn knob from the OFF position to the DUAL or TRIPLE zone anywhere between Lo and Hi.
2. Turn knob to OFF when finished.

## Warm Zone Element (on some models)

### **⚠ WARNING**

#### Food Poisoning Hazard

**Do not let food sit for more than one hour before or after cooking.**

**Doing so can result in food poisoning or sickness.**

The Warm Zone feature can be used to keep cooked foods warm. One hour is the recommended maximum time to maintain food quality.

Do not use it to heat cold foods.

When the Keep Warm function is in use, it will not glow red like the cooking zones, but the indicator light will glow on the control panel.

The Warm Zone feature can be used alone or when any of the other surface cooking areas are being used.

The Warm Zone Element area will not glow red when cycling on. However, the hot surface indicator light will glow as long as the Warm Zone Element area is too hot to touch.

- Use only cookware and dishes recommended for oven and cooktop use.
- Cover all foods with a lid or aluminum foil. When warming baked goods, allow a small opening in the cover for moisture to escape.
- Do not use plastic wrap to cover food. Plastic wrap may melt.
- Use pot holders or oven mitts to remove food.

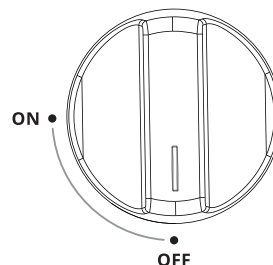

### To Use:

1. Push in and turn Warm Zone knob to ON.
2. Turn knob to OFF when finished.

## COOKTOP USE

### Ceramic Glass (on some models)

The surface cooking area will glow red when an element is on. Some parts of the surface cooking area may not glow red when an element is on. This is normal operation. The burner will cycle on and off to maintain the selected heat level. It will also randomly cycle off and back on again, even while on High, to keep the cooktop from extreme temperatures.

It is normal for the surface of light colored ceramic glass to appear to change color when surface cooking areas are hot. As the glass cools, it will return to its original color.

Cleaning off the cooktop before and after each use will help keep it free from stains and provide the most even heating. On cooktops with light colored ceramic glass, soils and stains may be more visible, and may require more cleaning and attention. Cooktop cleaner and a cooktop scraper are recommended. For more information, see "General Cleaning" section.

- Avoid storing jars or cans above the cooktop. Dropping a heavy or hard object onto the cooktop could crack the cooktop.
- To avoid damage to the cooktop, do not leave a hot lid on the cooktop. As the cooktop cools, air can become trapped between the lid and the cooktop, and the ceramic glass could break when the lid is removed.
- For foods containing sugar in any form, clean up all spills and soils as soon as possible. Allow the cooktop to cool down slightly. Then, while wearing oven mitts, remove the spills using a scraper while the surface is still warm. If sugary spills are allowed to cool down, they can adhere to the cooktop and can cause pitting and permanent marks.
- To avoid scratches, do not slide cookware or bakeware across the cooktop. Aluminum or copper bottoms and rough finishes on cookware or bakeware could leave scratches or marks on the cooktop.

- Do not cook popcorn in prepackaged aluminum containers on the cooktop. They could leave aluminum marks that cannot be removed completely.
- To avoid damage to the cooktop, do not allow objects that could melt, such as plastic or aluminum foil, to touch any part of the entire cooktop.
- To avoid damage to the cooktop, do not use the cooktop as a cutting board.
- Use cookware about the same size as the surface cooking area. Cookware should not extend more than ½" (1.3 cm) outside the area.

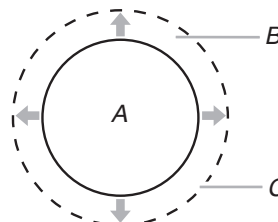

A. Surface cooking area  
B. Cookware/canner  
C. ½" (1.3 cm) maximum overhang

- Use flat-bottomed cookware for best heat conduction and energy efficiency. Cookware with rounded, warped, ribbed or dented bottoms could cause uneven heating and poor cooking results.
- Determine flatness by placing the straight edge of a ruler across the bottom of the cookware. While you rotate the ruler, no space or light should be visible between it and the cookware.

- Cookware designed with slightly indented bottoms or small expansion channels can be used.
- Make sure the bottoms of pots and pans are clean and dry before using them. Residue and water can leave deposits when heated.
- To avoid damage to the cooktop, do not cook foods directly on the cooktop.

## Home Canning

When canning for long periods, alternate the use of surface cooking areas, elements or surface burners between batches.

This allows time for the most recently used areas to cool.

- Center the canner on the grate or largest surface cooking area or element. On electric cooktops, canners should not extend more than ½" (1.3 cm) beyond the surface cooking area or element.
- Do not place canner on 2 surface cooking areas, elements or surface burners at the same time.
- On ceramic glass models, use only flat-bottomed canners.
- On coil element models, the installation of a Canning Unit Kit is recommended. If a kit is not installed, the life of the coil element will be shortened. See "Assistance or Service" for instructions on how to order.
- For more information, contact your local agricultural department. Companies that manufacture home canning products can also offer assistance.

## Cookware

**IMPORTANT:** Do not leave empty cookware on a hot surface cooking area, element or surface burner.

Ideal cookware should have a flat bottom, straight sides, and a well-fitting lid and the material should be of medium-to-heavy thickness.

Rough finishes may scratch the cooktop. Aluminum and copper may be used as a core or base in cookware. However, when used as a base they can leave permanent marks on the cooktop or grates.

Cookware material is a factor in how quickly and evenly heat is transferred, which affects cooking results. A nonstick finish has the same characteristics as its base material.

For example, aluminum cookware with a nonstick finish will take on the properties of aluminum.

Use the following chart as a guide for cookware material characteristics.

Cookware	Characteristics
Aluminum	<ul style="list-style-type: none"> <li>■ Heats quickly and evenly.</li> <li>■ Suitable for all types of cooking.</li> <li>■ Medium or heavy thickness is best for most cooking tasks.</li> </ul>
Cast iron	<ul style="list-style-type: none"> <li>■ Heats slowly and evenly.</li> <li>■ Good for browning and frying.</li> <li>■ Maintains heat for slow cooking.</li> </ul>
Ceramic or Ceramic glass	<ul style="list-style-type: none"> <li>■ Follow manufacturer's instructions.</li> <li>■ Heats slowly, but unevenly.</li> <li>■ Ideal results on low to medium heat settings.</li> </ul>
Medium Low	<ul style="list-style-type: none"> <li>■ Stew or steam food.</li> <li>■ Simmer.</li> </ul>
Copper	<ul style="list-style-type: none"> <li>■ Heats very quickly and evenly.</li> </ul>
Porcelain enamel-onsteel or cast iron	<ul style="list-style-type: none"> <li>■ See stainless steel or cast iron.</li> </ul>
Stainless steel	<ul style="list-style-type: none"> <li>■ Heats quickly, but unevenly.</li> <li>■ A core or base of aluminum or copper on stainless steel provides even heating.</li> </ul>

# COOKTOP CARE

## General Cleaning

**IMPORTANT:** Before cleaning, make sure all controls are off and the cooktop is cool. Always follow label instructions on cleaning products.

Soap, water and a soft cloth or sponge are suggested first unless otherwise noted. When cleaning the cooktop with electronic controls, lock the controls. See "Control Lock" section.

Do not use a steam cleaner.

### STAINLESS STEEL (on some models)

To avoid damage to stainless steel surfaces, do not use soapfilled scouring pads, abrasive cleaners, Cooktop Cleaner, steelwool pads, gritty washcloths or abrasive paper towels.

#### Cleaning Method:

Rub in direction of grain to avoid damaging.

- Affresh® Stainless Steel Cleaner and Polish (Part Number W10355016B) (not included): See "Assistance or Service" section to order.
- All-purpose cleaner: Rinse with clean water and dry with soft, lint-free cloth.
- Vinegar for hard water spots.

### COOKTOP CONTROLS

To avoid damage to the cooktop controls, do not use steel wool, abrasive cleansers or oven cleaner.

To avoid damage, do not soak knobs.

When replacing knobs, make sure knobs are in the Off position.

Do not remove seals under knobs.

#### Cleaning Method:

- Soap and water: Pull knobs straight away from control panel to remove.
- Do not place knobs in dishwasher.

---

## CERAMIC GLASS

---

### Cleaning Method:

To avoid damaging the cooktop, do not use steel wool, abrasive powder cleansers, chlorine bleach, rust remover, or ammonia.

1. Remove food/residue with the Cooktop Scraper.

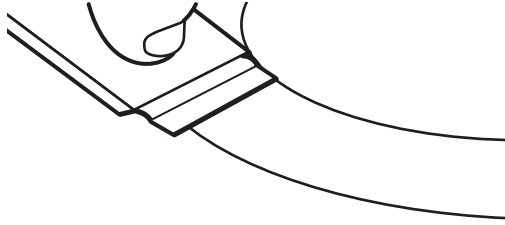

- For best results, use the Cooktop Scraper while the cooktop is still warm but not hot to the touch. It is recommended to wear an oven mitt while scraping the warm cooktop.
- Hold the Cooktop Scraper at approximately a 45° angle against the glass surface and scrape the residue. It will be necessary to apply pressure in order to remove the residue.

Allow the cooktop to cool down completely before proceeding to Step 2.

2. Apply a few dime-sized drops of affresh® Cooktop Cleaner to the affected areas.

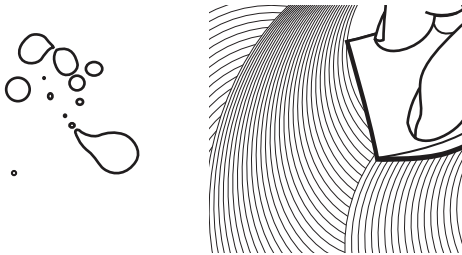

- Rub affresh® Cooktop Cleaner onto the cooktop surface with the blue Cooktop Cleaning Pad. Some pressure is needed to remove stubborn stains.
  - Allow the cleaner to dry to a white haze before proceeding to Step 3.
3. Polish with a clean, dry cloth or a clean, dry paper towel.



- Repeat steps 1 through 3 as necessary for stubborn or burned-on stains.

The Complete Cooktop Cleaner Kit is available for order and includes the following:

- Cooktop Scraper
- Affresh® Cooktop Cleaner
- Blue Cooktop Cleaning Pads

See the “Accessories” section for part numbers and information on ordering.

# TROUBLESHOOTING

First try the solutions suggested here. If you need further assistance or more recommendations that may help you avoid a service call, visit [http://www.whirlpool.com/product\\_help](http://www.whirlpool.com/product_help). In Canada, visit <http://www.whirlpool.ca>. In Mexico, visit <http://www.whirlpool.mx/servicio>.

Contact us by mail with any questions or concerns at the address below.

In the U.S.A.:

Whirlpool Brand Home Appliances  
Customer eXperience Center  
553 Benson Road  
Benton Harbor, MI 49022-2692

In Canada:

Whirlpool Brand Home Appliances  
Customer eXperience Center  
200 - 6750 Century Ave.  
Mississauga, Ontario L5N 0B7

In Mexico:

Whirlpool México, S. de R.L. de C.V.  
Carretera Miguel Alemán Km 16.13  
Col. El Milagro  
Apodaca, Nuevo León  
México, C.P. 66634

Please include a daytime phone number in your correspondence.

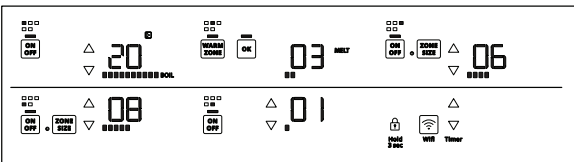
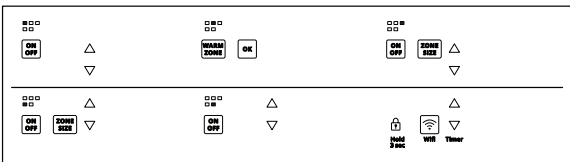
Problem	Possible Causes and/or Solutions
Nothing will operate	<b>A household fuse has blown or a circuit breaker has tripped:</b> Replace the fuse or reset the circuit breaker. If the problem continues, call an electrician. <b>Cooktop isn't wired properly:</b> See the Installation Instructions.
Cooktop will not operate	<b>Control knob set incorrectly:</b> Push in knob before turning to a setting. One or more burners stopped working during use: Allow the cooktop to cool down for 30 minutes, Then turn the burner on again. <b>Control Lock is not set:</b> Press and hold "Control Lock" for 3 seconds
Excessive heat around cookware on cooktop	<b>Cookware is not the proper size:</b> Use cookware about the same size as the surface cooking area, element, or surface burner. Cookware should not extend more than 1/2" (1.3 cm) outside the cooking area. <b>Cooktop surfaces become hot:</b> When cooktop is in use, the entire cooktop area may become hot.
Cooktop cooking results not what expected	<b>Proper cookware is not being used:</b> See the "Cookware" section. <b>Control knob is not set to the proper heat level:</b> See the "Cooktop Controls" section. <b>Cooktop is not level:</b> Level the cooktop. See the Installation Instructions. <b>Certain power levels seem to take longer to cook food or some power levels do not perform as well as usual:</b> The cooktop regulates the temperature of the internal components and automatically reduces the power of all the elements in use without any visual or audible feedback. Allow the cooktop to cool down for 30 minutes to resume normal cooking performance. See "To Use" in the "Cooktop Controls" section.
Cooktop is beeping	<b>Key is pressed and held:</b> Remove any objects left on the control area, or wipe any debris from the control panel surface. If the cooktop continues beeping for longer than 15 minutes, the control panel will lock, and the F2E1 code will appear in the display. See "Cooktop is displaying F2E1 code" in this section.
Cooktop has flashing lights	<b>The lights on the cooktop are flashing on and off:</b> All cooktop control panel lights flash on and off, indicating that one or more keys are permanently pressed. Follow the steps below.  <i>All cooktop control panel lights On</i>  <i>All cooktop control panel lights Off</i> <ol style="list-style-type: none"><li>1. Make sure the cooktop controls are OFF.</li><li>2. Clean the cooktop touch control panel thoroughly. See "General Cleaning" section.</li><li>3. If the cooktop lights continue to flash, disconnect power or unplug the cooktop.</li><li>4. After 1 minute, reconnect power or plug in the cooktop.</li><li>5. If the lights continue to blink on and off, call for service.</li></ol>
Cooktop is displaying F2E1 code	<b>Cooktop is displaying F2E1, indicating that one or more keys are permanently pressed:</b> Follow the steps below. <ol style="list-style-type: none"><li>1. Make sure the cooktop controls are off.</li><li>2. Clean the cooktop touch control panel thoroughly. See the "General Cleaning" section.</li><li>3. Disconnect power or unplug the cooktop.</li><li>4. After 1 minute, reconnect power or plug in the cooktop.</li><li>5. If error returns after 1 minute, call for service.</li></ol>

---

# ASSISTANCE OR SERVICE

Before calling for assistance or service, please check "Troubleshooting." It may save you the cost of a service call. If you still need help, follow the instructions below.

When calling, please know the purchase date and the complete model and serial number of your appliance. This information will help us to better respond to your request.

## If you need replacement parts

If you need to order replacement parts, we recommend that you use only FSP® replacement parts. FSP® replacement parts will fit right and work right because they are made with the same precision used to build every new WHIRLPOOL appliance.

To locate FSP® replacement parts in your area, call us or your nearest Whirlpool designated service center.

---

## In the U.S.A.

Call the Whirlpool Customer eXperience Center toll free: **1-800-253-1301** or visit **www.whirlpool.com**.

### Our consultants provide assistance with:

- Features and specifications on our full line of appliances.
- Installation information.
- Use and maintenance procedures.
- Accessory and repair parts sales.
- Specialized customer assistance (Spanish speaking, hearing impaired, limited vision, etc.).
- Referrals to local dealers, repair parts distributors and service companies. Whirlpool designated service technicians are trained to fulfill the product warranty and provide afterwarranty service, anywhere in the United States.

To locate the Whirlpool designated service company in your area, you can also look in your telephone directory Yellow Pages.

### For further assistance

If you need further assistance, you can write to Whirlpool Corporation with any questions or concerns at:

Whirlpool Brand Home Appliances  
Customer eXperience Center  
553 Benson Road  
Benton Harbor, MI 49022-2692

Please include a daytime phone number in your correspondence.

---

## Accessories

### Accessories U.S.A.

To order accessories, visit our website at **www.whirlpool.com/cookingaccessories**

#### Canning Unit Kit

(coil element models)  
Order Part Number 242905

#### Cooktop Cleaner

(ceramic glass models)  
Order Part Number 31464

#### Cooktop Protectant

(ceramic glass models)  
Order Part Number 31463

#### Cooktop Care Kit

(includes cleaner, protectant, and applicator pads)  
Order Part Number 31605

#### Cooktop Scraper

(ceramic glass models)  
Order Part Number WA906B

#### All-Purpose Appliance Cleaner

Order Part Number 31682

---

## In Canada

Call the Whirlpool Canada LP Customer eXperience Centre toll free: **1-800-807-6777**.

Our consultants provide assistance with:

- Features and specifications on our full line of appliances.
- Use and maintenance procedures.
- Accessory and repair parts sales.
- Referrals to local dealers, repair parts distributors, and service companies. Whirlpool Canada LP designated service technicians are trained to fulfill the product warranty and provide after-warranty service, anywhere in Canada.

### For further assistance

If you need further assistance, you can write to Whirlpool Canada LP with any questions or concerns at:

Customer eXperience Centre  
Whirlpool Canada LP  
200 - 6750 Century Ave.  
Mississauga, Ontario L5N 0B7

Please include a daytime phone number in your correspondence.

---

## In Mexico

Call the Whirlpool Service Center:

Teléfono: **(81) 8329-2100**

Dentro de la Republica Mexicana

Teléfono: **01 (81) 8329-2100**

or visit **www.whirlpool.mx/servicio**

### For further assistance

If you need further assistance, you can write to Whirlpool Properties with any questions or concerns at:

Whirlpool México, S. de R.L. de C.V.  
Carretera Miguel Alemán Km 16.13,  
Col. El Milagro, Apodaca,  
Nuevo León, México, C.P. 66634

Please include a daytime phone number in your correspondence.