

MANUAL INSTRUCTION

Buffet Cabinet with Storage

H22006

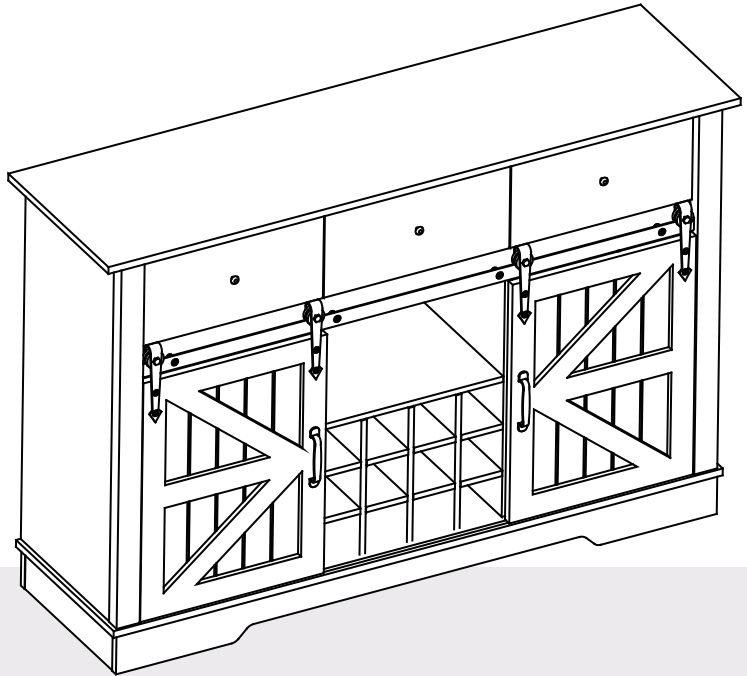

Buffet Cabinet with Storage H22006

We offer a diverse range of products to meet the needs of customers.

Indoor Furniture

We are a professional furniture provider with top-notch factories and outstanding designs, Our mission is to provide consumers with new lifestyles. By collecting consumer feedback, we constantly improve our products and create more choices for consumers. If you want to create your space, We are an ideal choice.

Always.



WARNING

All the High Locker have passed strict quality inspections before delivery . Read this manual carefully to ensure proper usage

Ensure that all parts and hardware are available before beginning assembly

NOTICE

1. Children are not allowed to operate.
2. Faster installation is possible with power tools.
3. Do not pull the door vigorously to prevent the storage cabinet from tipping over.
4. Please attach the storage cabinet to the wall with an anti-tip device after installation is complete.
5. When using the storage cabinet for the first time, please keep it in a ventilated environment to allow the smell to fully evaporate.
6. When placing the partitions, please make sure the nails are firmly installed to prevent the partitions from falling off.
7. If any parts are missing, broken, damaged or worn, discontinue use of the product until repairs are made and/or factory replacement parts are installed.
8. Do not use this product in a manner inconsistent with the manufacturer's instructions, as this may void the product warranty.
9. If accessories are missing, please contact customer service for communication in time, we provide 7x24 hours customer care.
10. Do not use any attachments or accessories other than the original factory attachments and accessories.
11. Do not alter this equipment. Any alteration will create a safety hazard.

WARNING

The product must be assembled by adult before use. Serious or fatal injury may occur from unexpected assembly or use.

1. During the assembly process, keep all parts away from babies or children.
2. Always securely fix this product to the wall. Make sure the wall area to be drilled is free from hidden electrical wires, water and gas pipes.
3. Use of tip-over restraints may only reduce, but not eliminate the risk of tip-over.
4. Unless specially designed to accommodate, do not set heavy objects on top of this product.
5. Place the heaviest items on the lowest shelf.
6. Never allow children to climb or bang on drawers, doors or shelves.

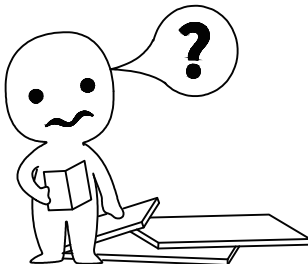
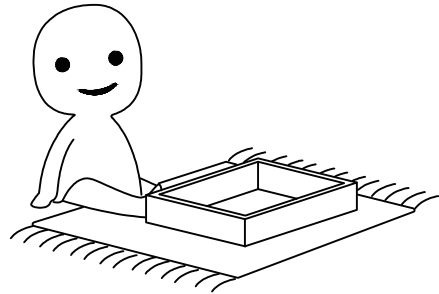
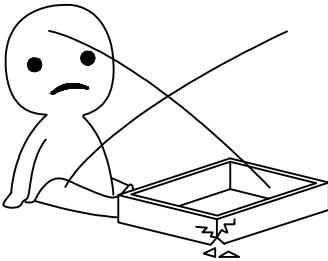
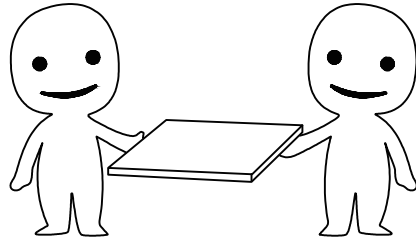
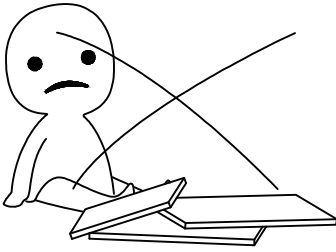
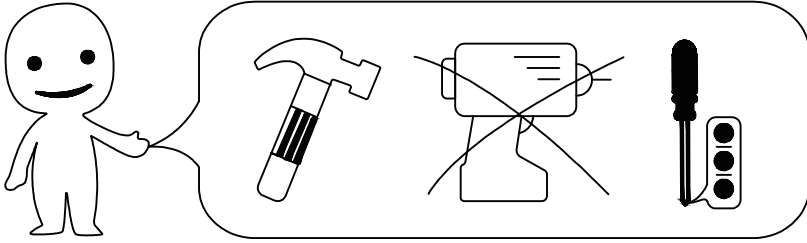

DE

Wichtige Information

- Sorgfältig und aufmerksam lesen
- Diese Information aufbewahren

GB

Safety information

- Important information
- Please read closely and carefully
- Save this information

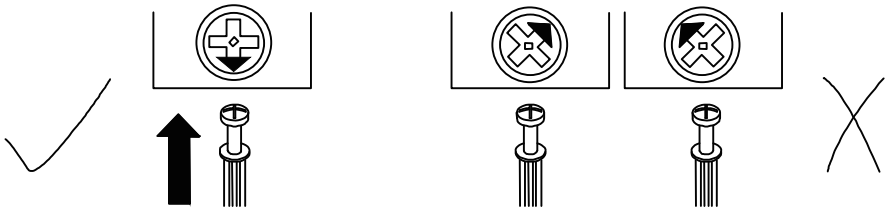
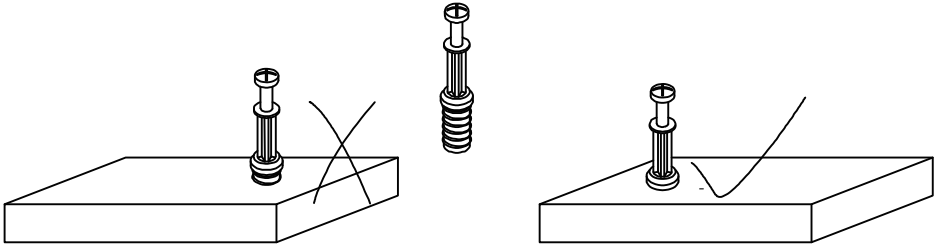

**Nut should be in the centred of the cam lock when the two panels are joined.
Cam lock should be inserted before nut.**

Wenn die beiden Platten verbunden sind, sollte die Mutter in der Mitte des Nockenschlosses sein.

Die Nockenverriegelung sollte vor der Mutter eingeführt werden.

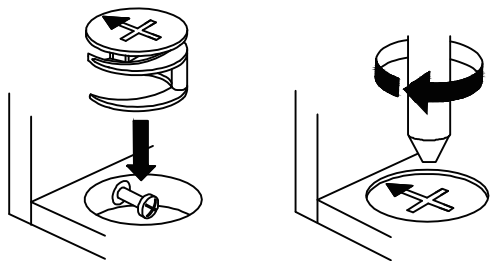

TOOLS REQUIRED



PHILLIPS
SCREWDRIVER



2Persons Assembly



Minimum 60 Minutes For Assembly

HARDWARE

1

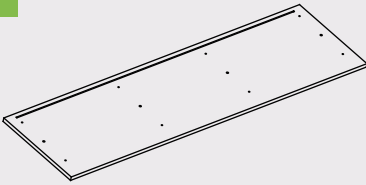

1 PC

2

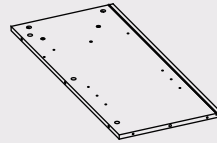

1 PC

3

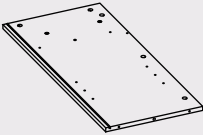

1 PC

4

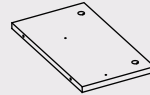

2 PCS

5

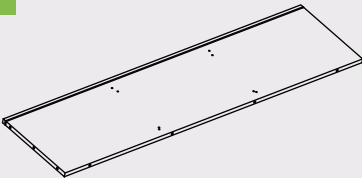

1 PC

6

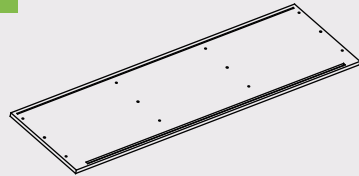

1 PC

7

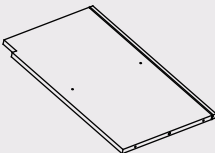

1 PC

8

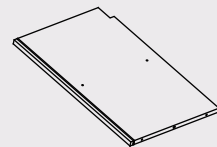

1 PC

HARDWARE

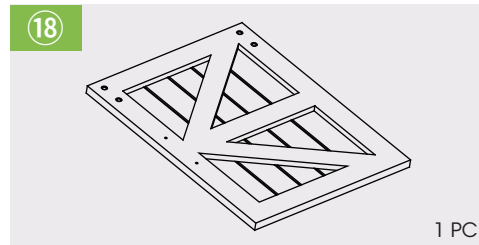
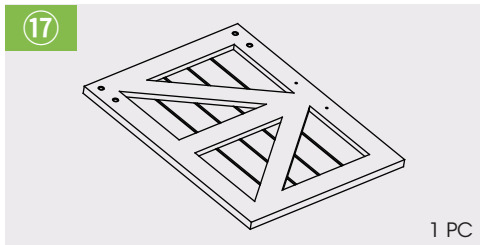
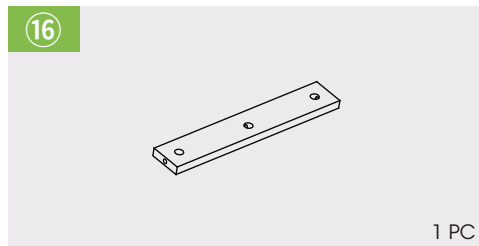
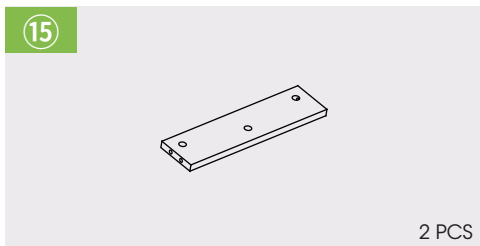
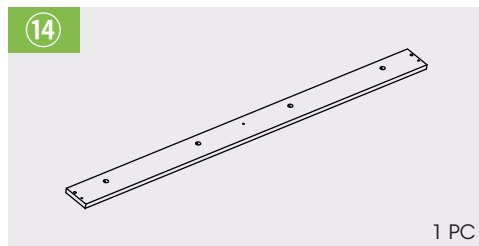
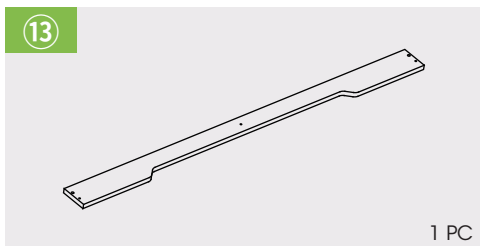
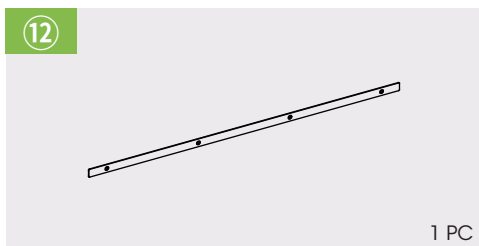
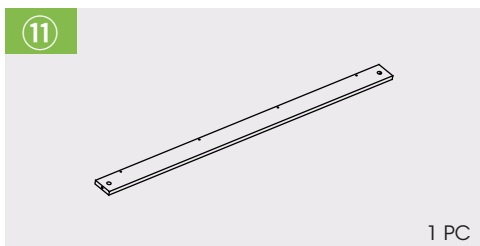
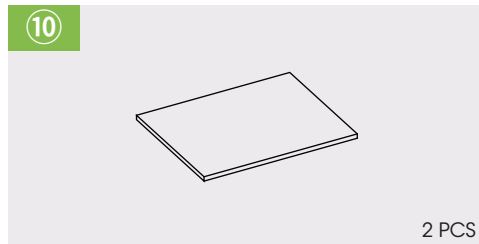
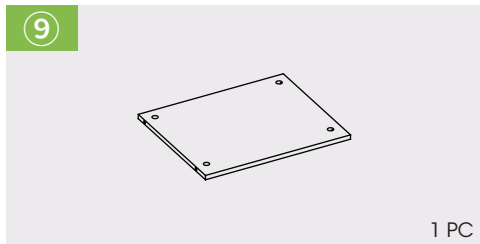

HARDWARE

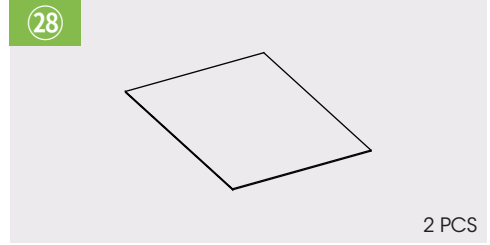
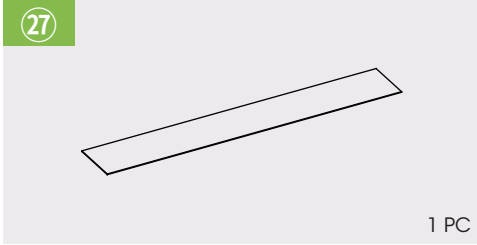
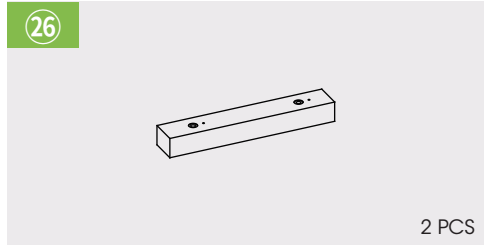
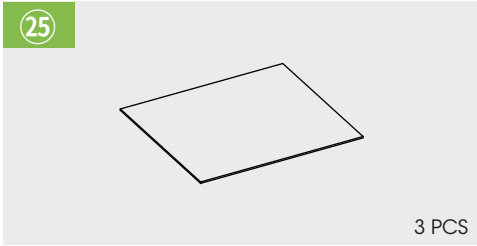
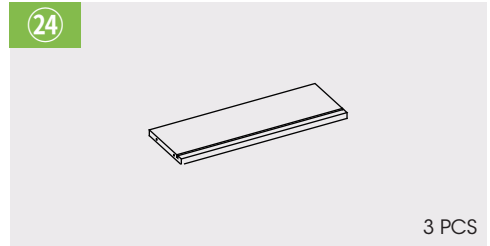
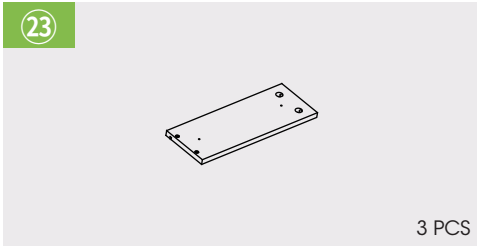
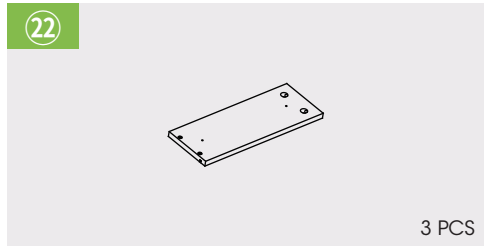
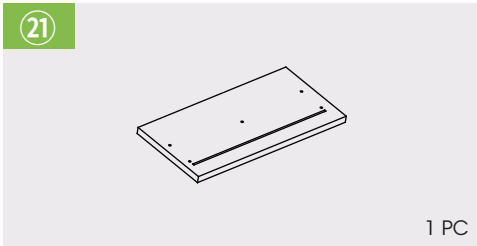
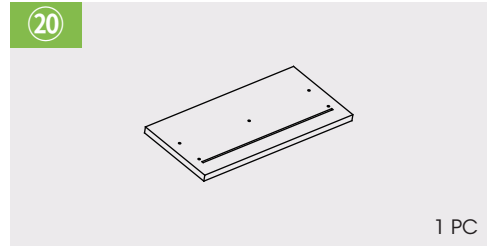
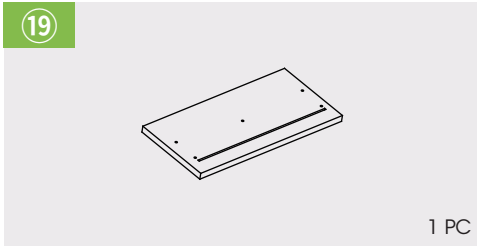

HARDWARE

29

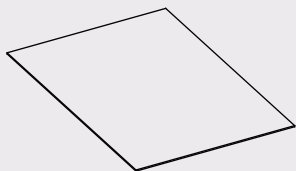

1 PC

30



4 PCS

31

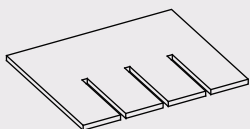

2 PCS

32

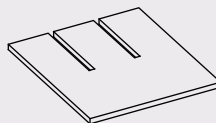

3 PCS

33

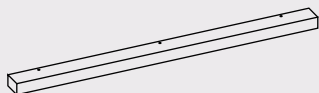

2 PCS

PARTS

A



57 PCS

B M15x9.5mm



57 PCS

C M8x30mm



16 PCS

D M7x47mm

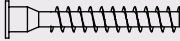

12 PCS

E M6x40mm

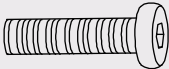

4 PCS

F M3.5x12mm



36 PCS

G

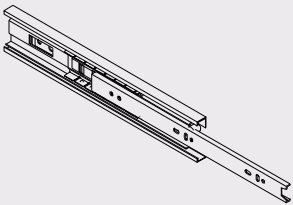

6 PCS

H M6x30mm

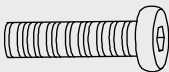

4 PCS

I M16x19mm



4 PCS

J



8 PCS

PARTS

K



2 PCS

L M4x22mm

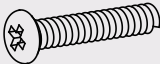

7 PCS

M M6x12mm

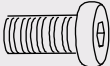

8 PCS

N

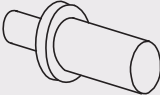

4 PCS

O M3.5x35mm

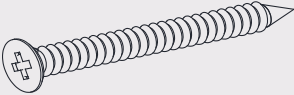

12 PCS

P



3 PCS

Q



1 PC

R M4



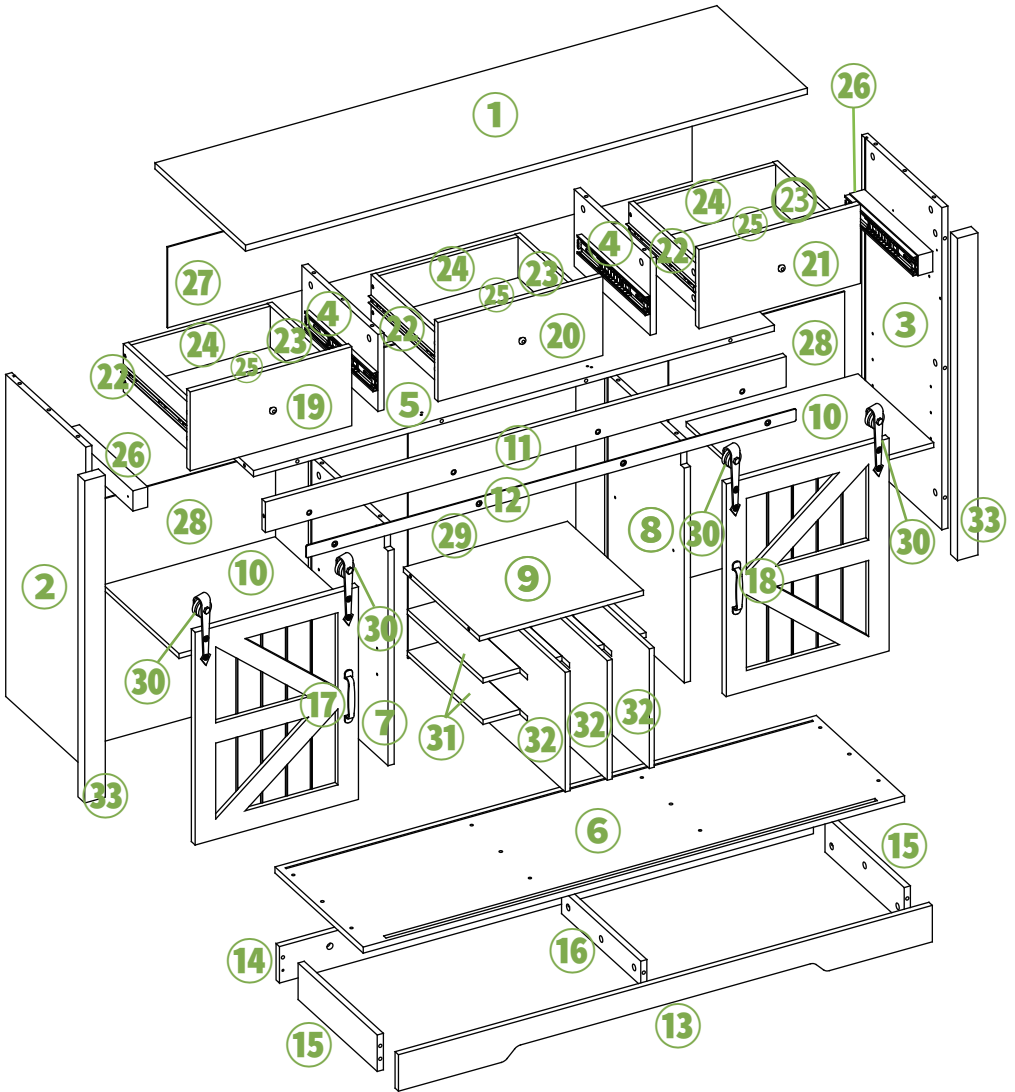

1 PC

I BOARD IDENTIFICATION



PRODUCT ASSEMBLY

1

PART	NO.	QTY.
	A	18
	C	2
	Q	1

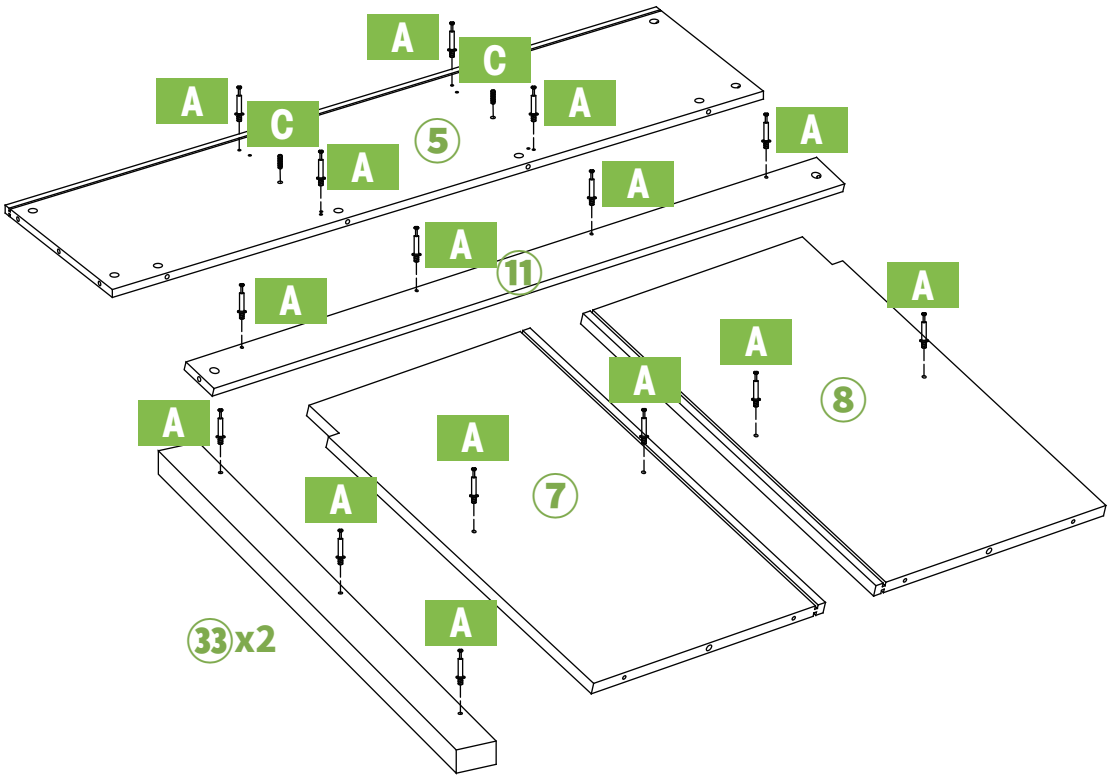

PRODUCT ASSEMBLY



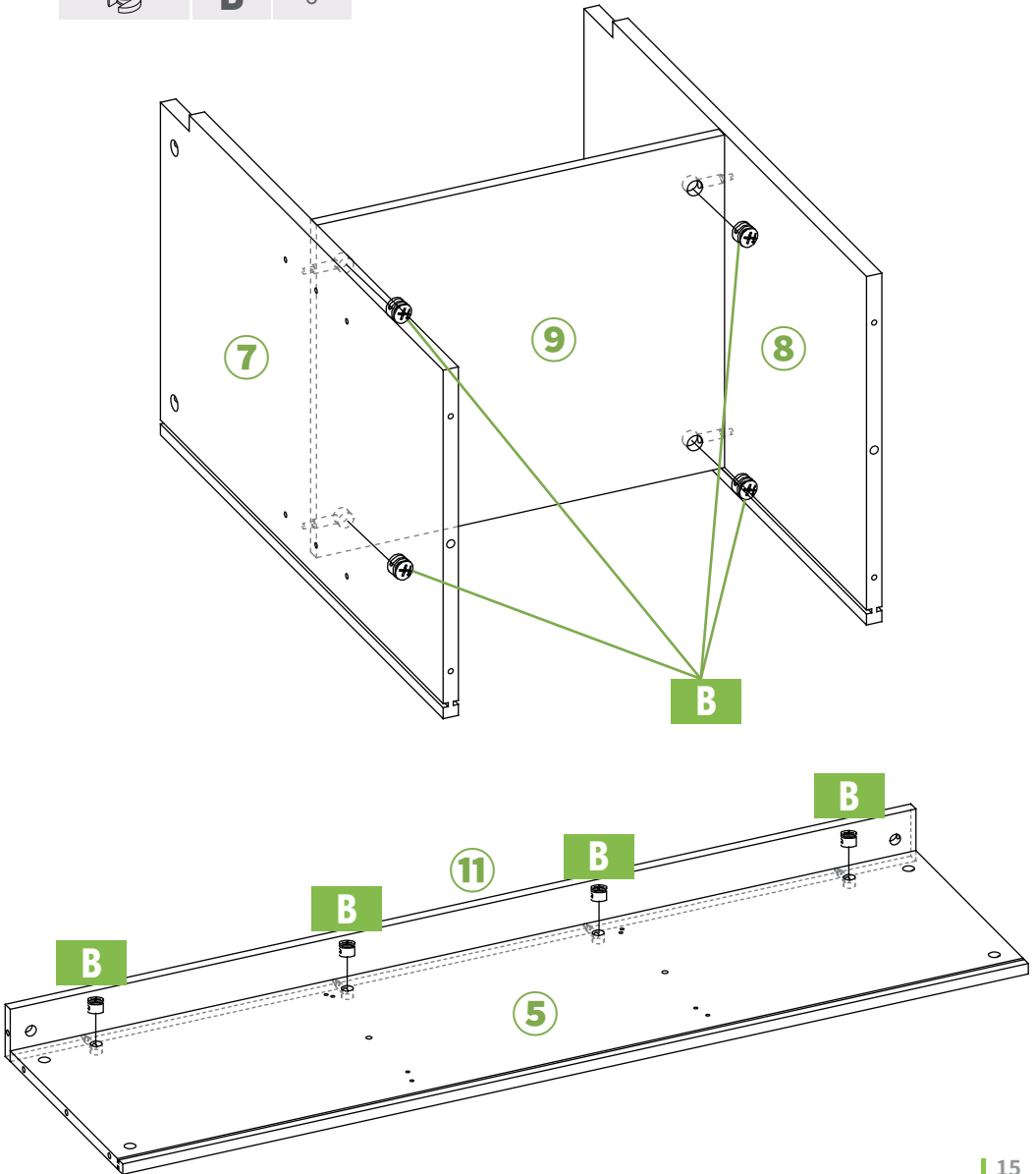

2

PART	NO.	QTY.
	B	8



PRODUCT ASSEMBLY

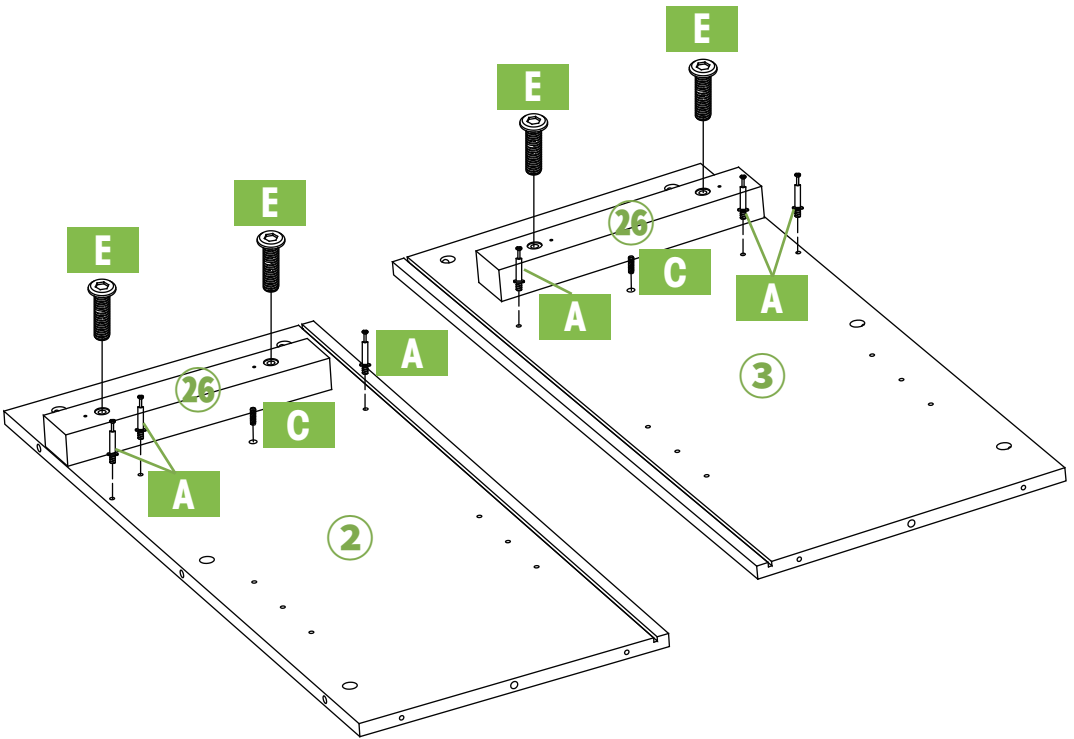

3

PART	NO.	QTY.
	A	6
	C	2
	E	4
	R	1



PRODUCT ASSEMBLY

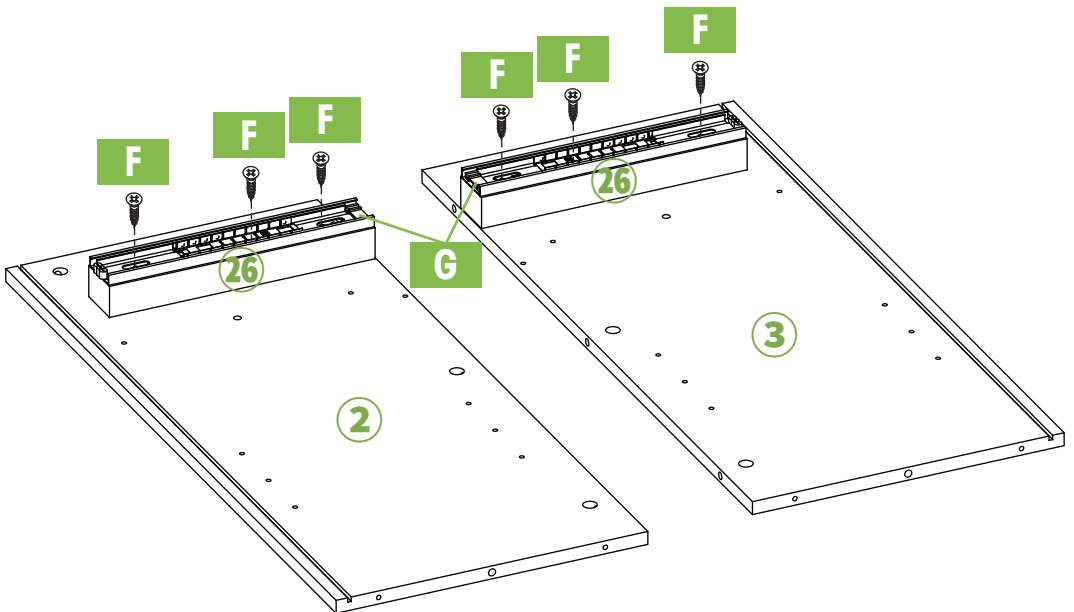
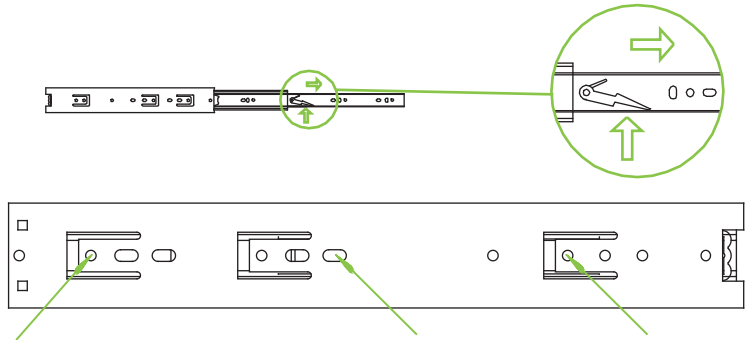

4

PART	NO.	QTY.
	F	6
	G	2



PRODUCT ASSEMBLY

5

PART	NO.	QTY.
	F	12
	G	4

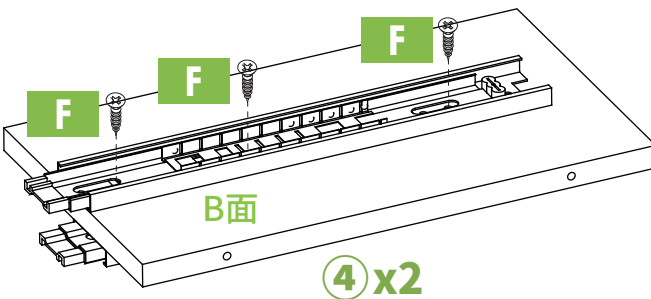
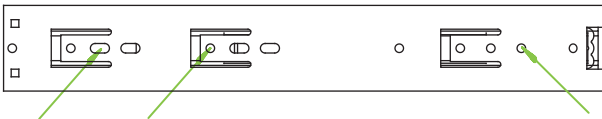
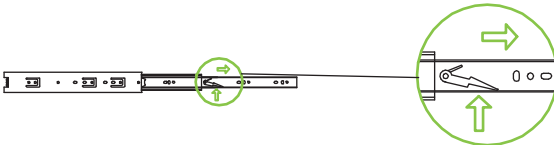
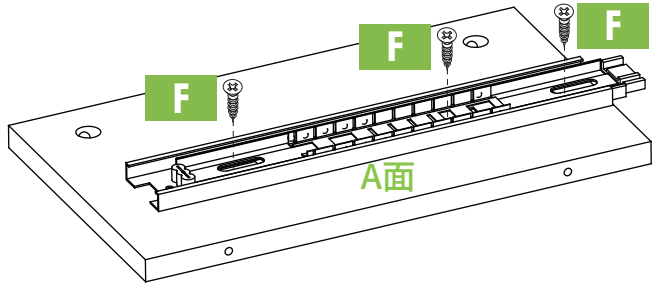
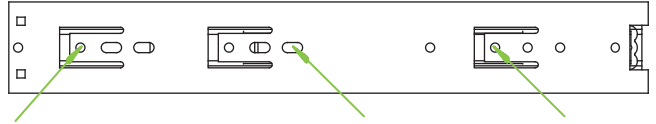
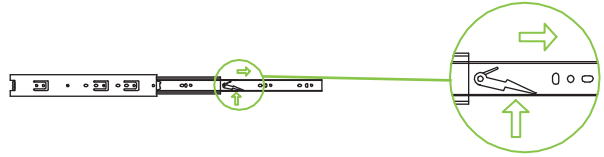

PRODUCT ASSEMBLY

6

PART	NO.	QTY.
	B	6

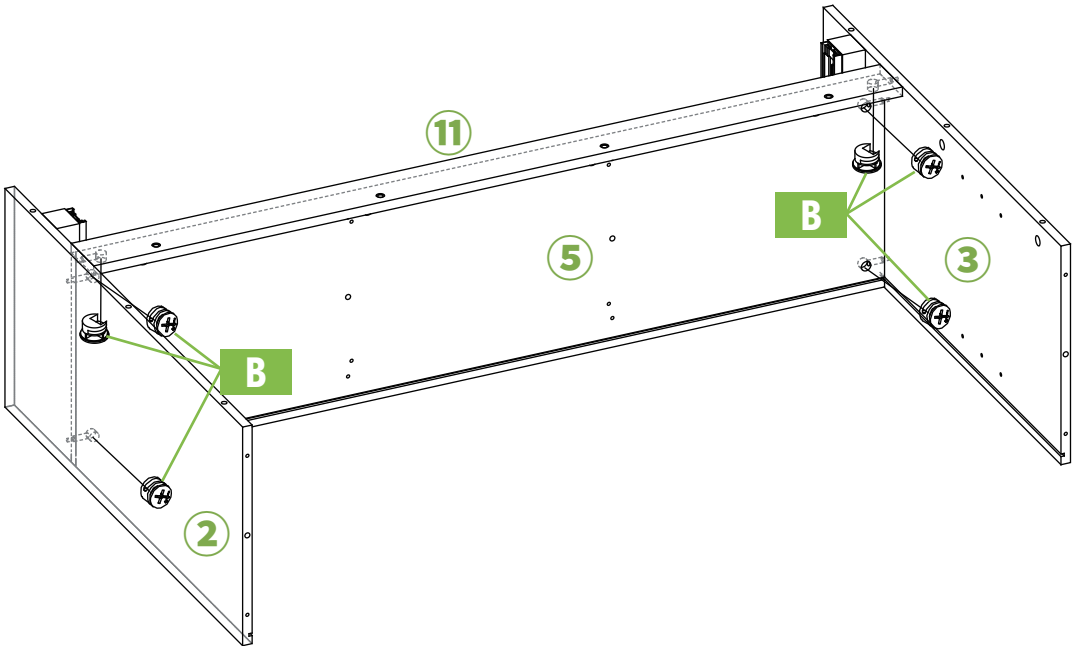

PRODUCT ASSEMBLY

7

PART	NO.	QTY.
	D	4

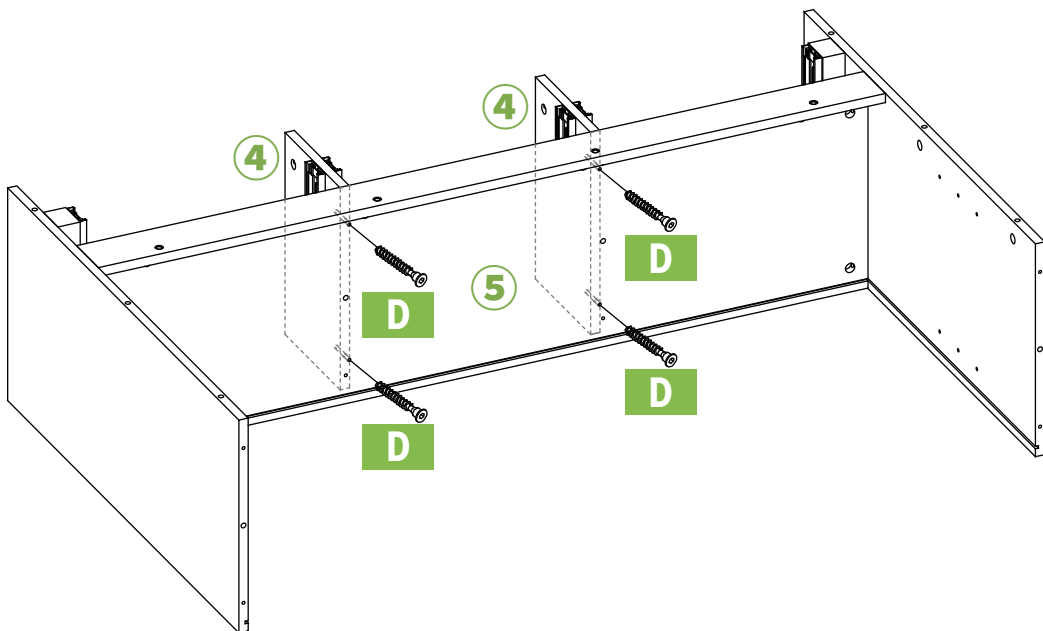

PRODUCT ASSEMBLY

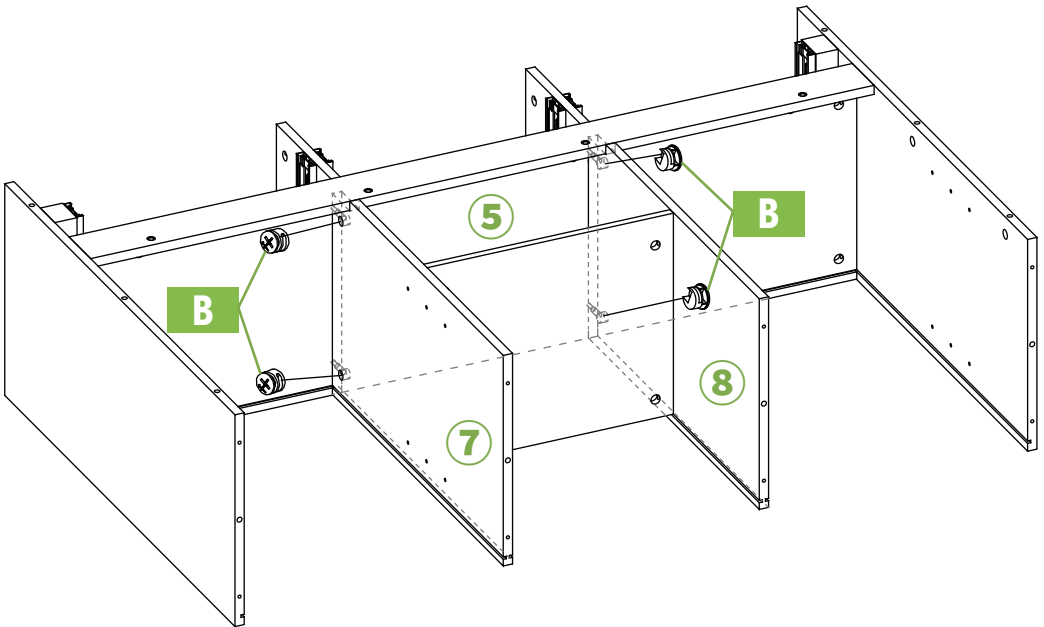

8

PART	NO.	QTY.
	B	4



PRODUCT ASSEMBLY

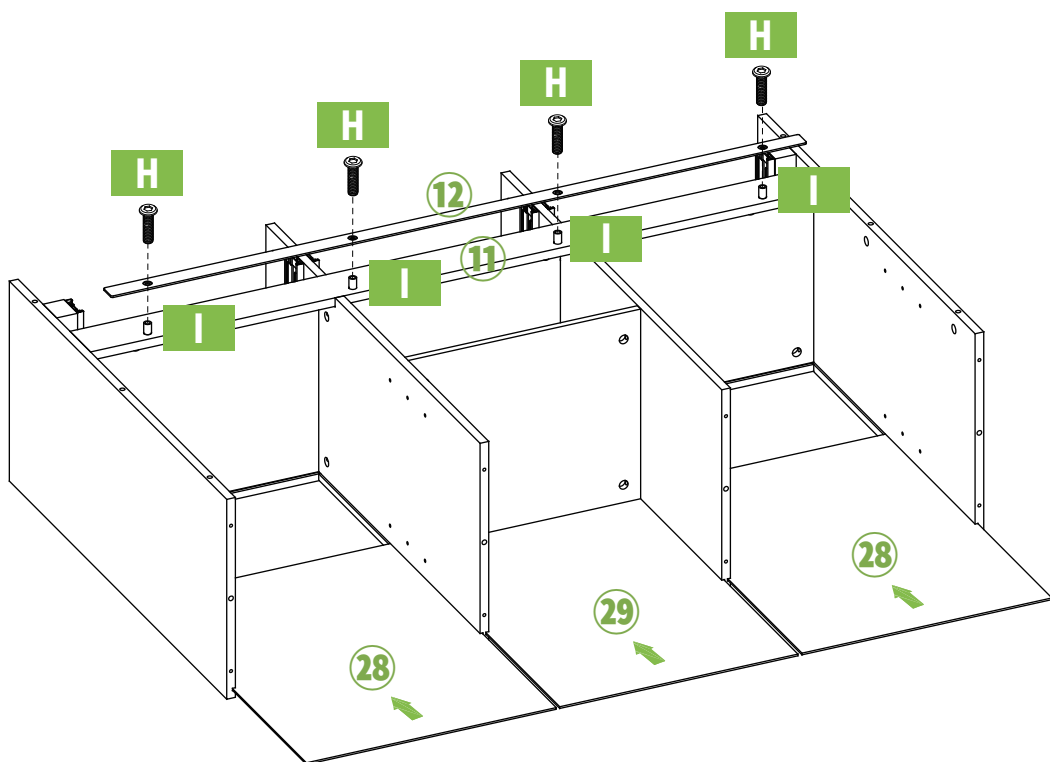

9

PART	NO.	QTY.
	H	4
	I	4

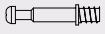

PRODUCT ASSEMBLY

10

PART	NO.	QTY.
	A	8
	C	8

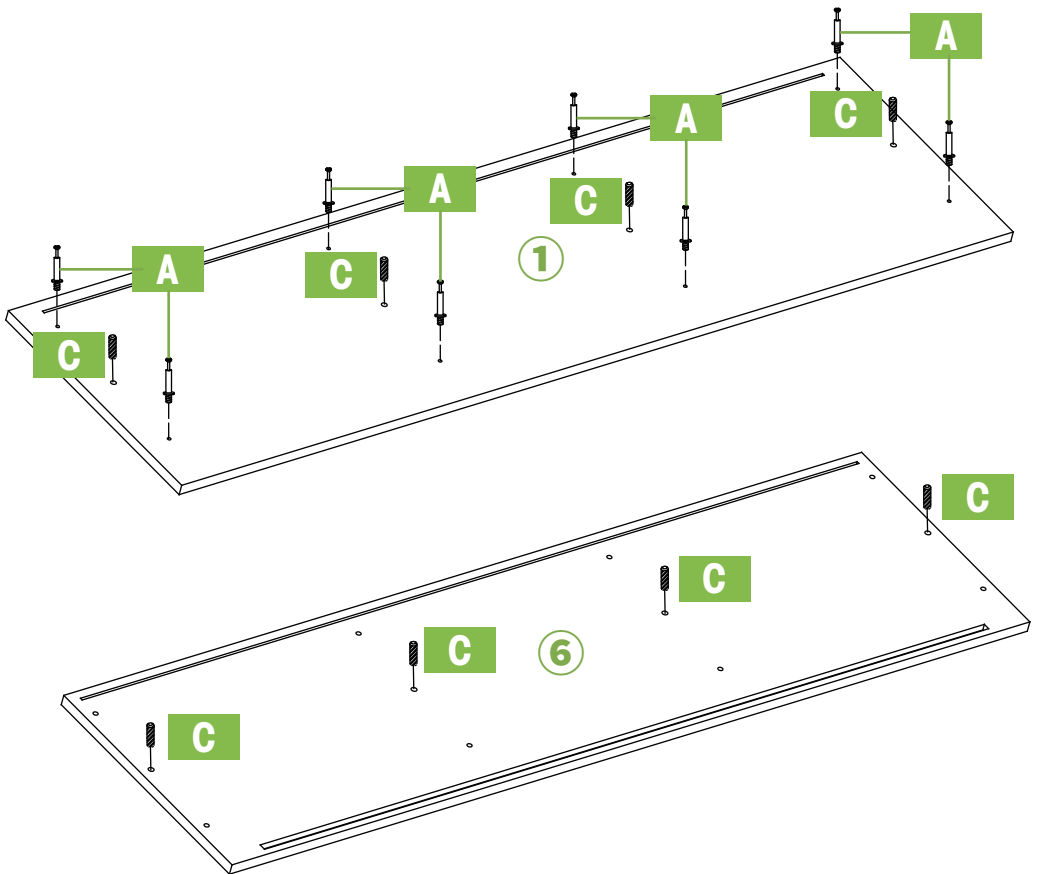

PRODUCT ASSEMBLY

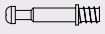
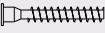

11

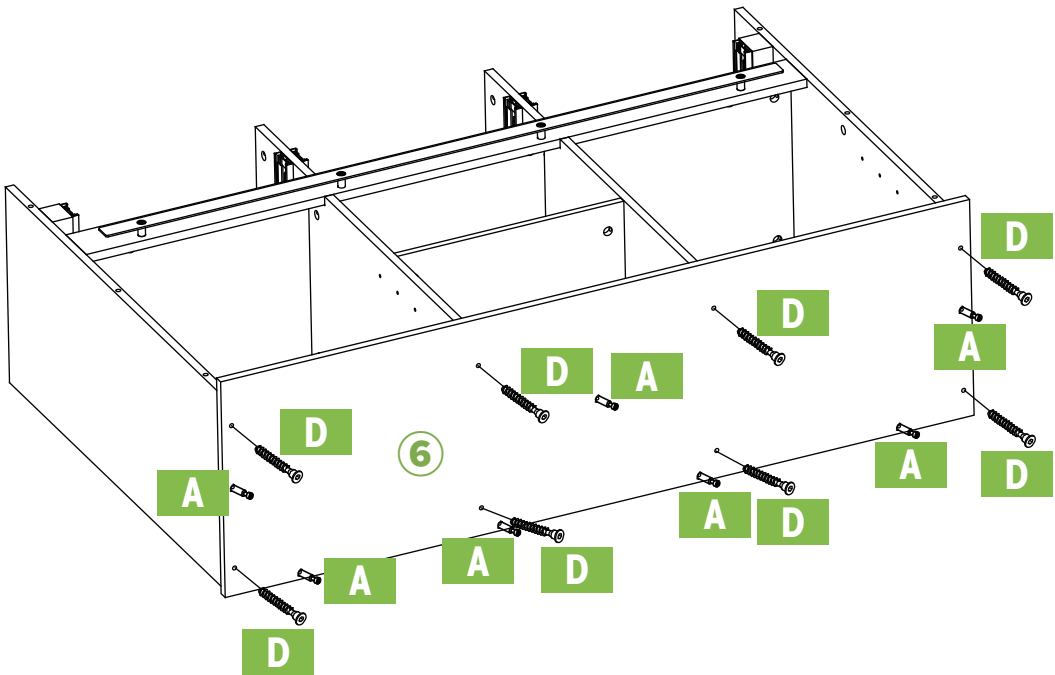
PART	NO.	QTY.
	A	7
	D	8



PRODUCT ASSEMBLY

12

PART	NO.	QTY.
	A	6
	B	6
	C	4

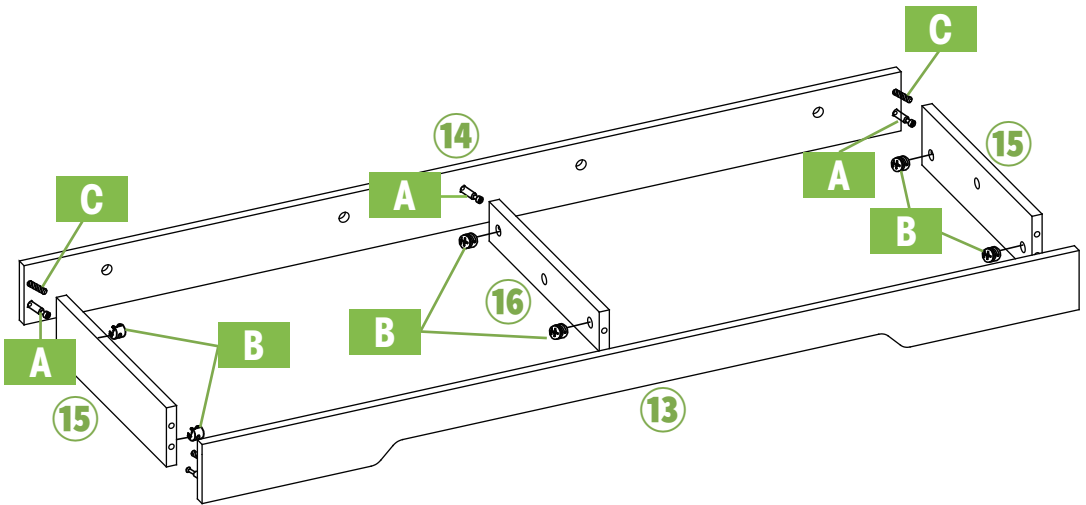

PRODUCT ASSEMBLY

13

PART	NO.	QTY.
	B	7

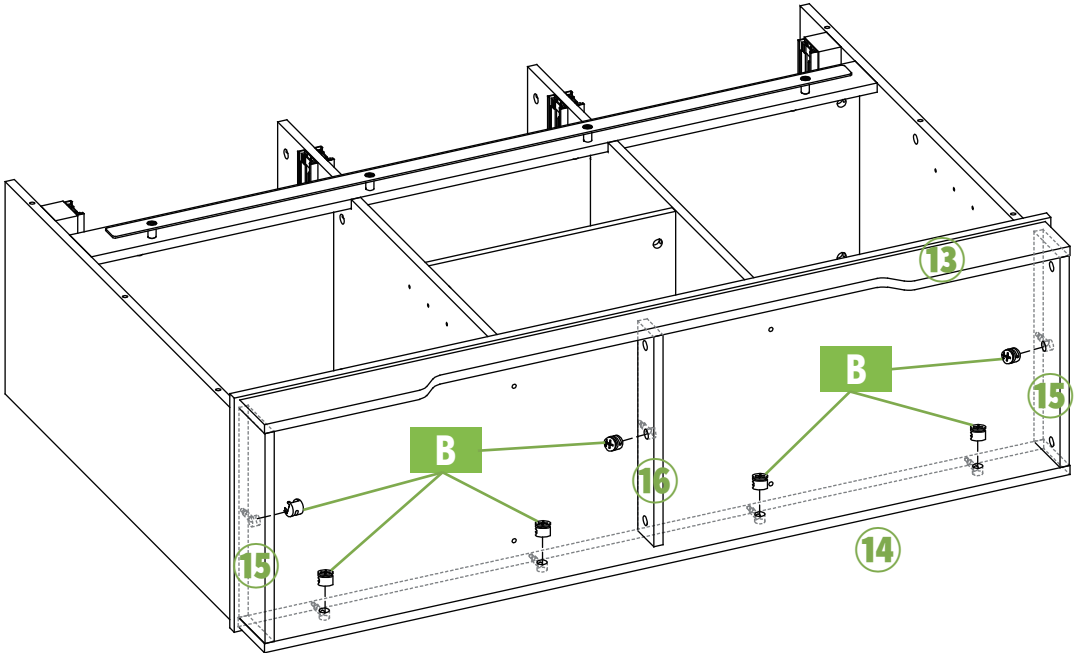

PRODUCT ASSEMBLY

14

PART	NO.	QTY.
	J	8

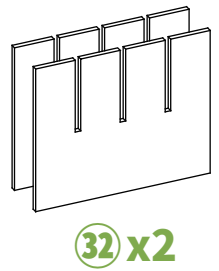
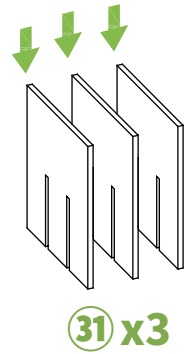
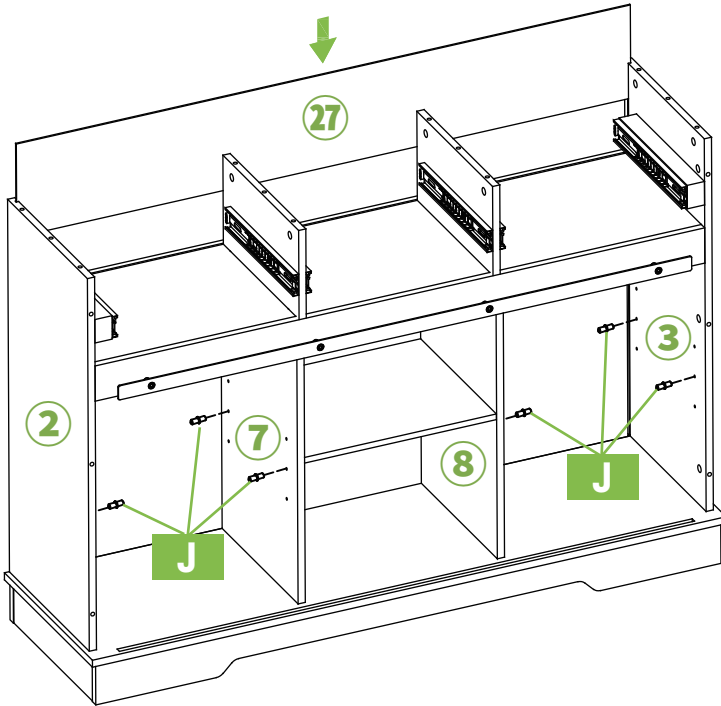

PRODUCT ASSEMBLY

15

PART	NO.	QTY.
	B	8

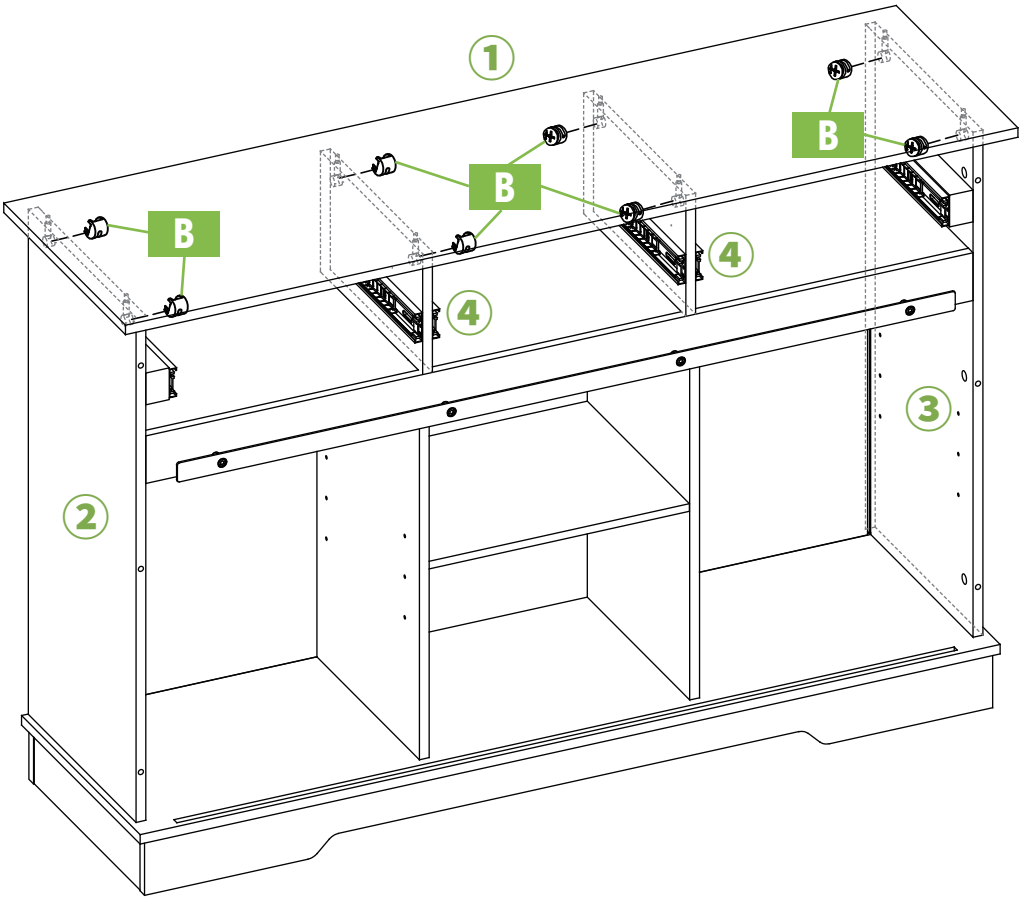

PRODUCT ASSEMBLY

16

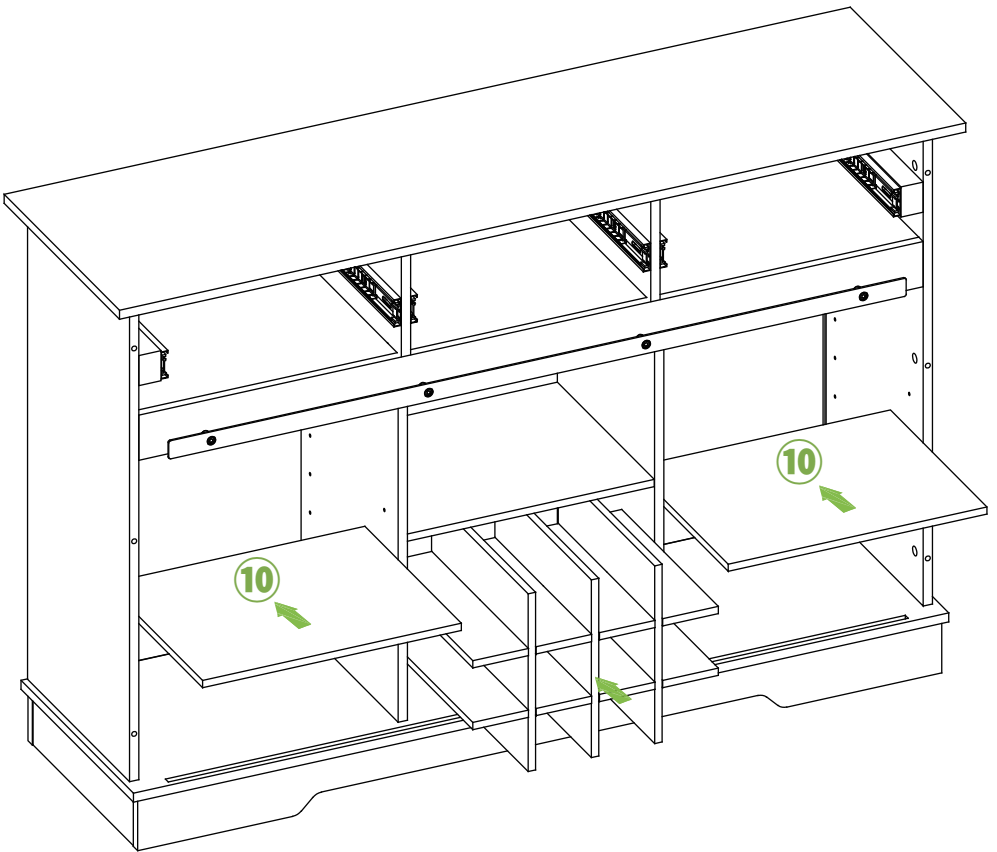

PRODUCT ASSEMBLY

17

PART	NO.	QTY.
	K	2
	L	4
	M	8
	N	4

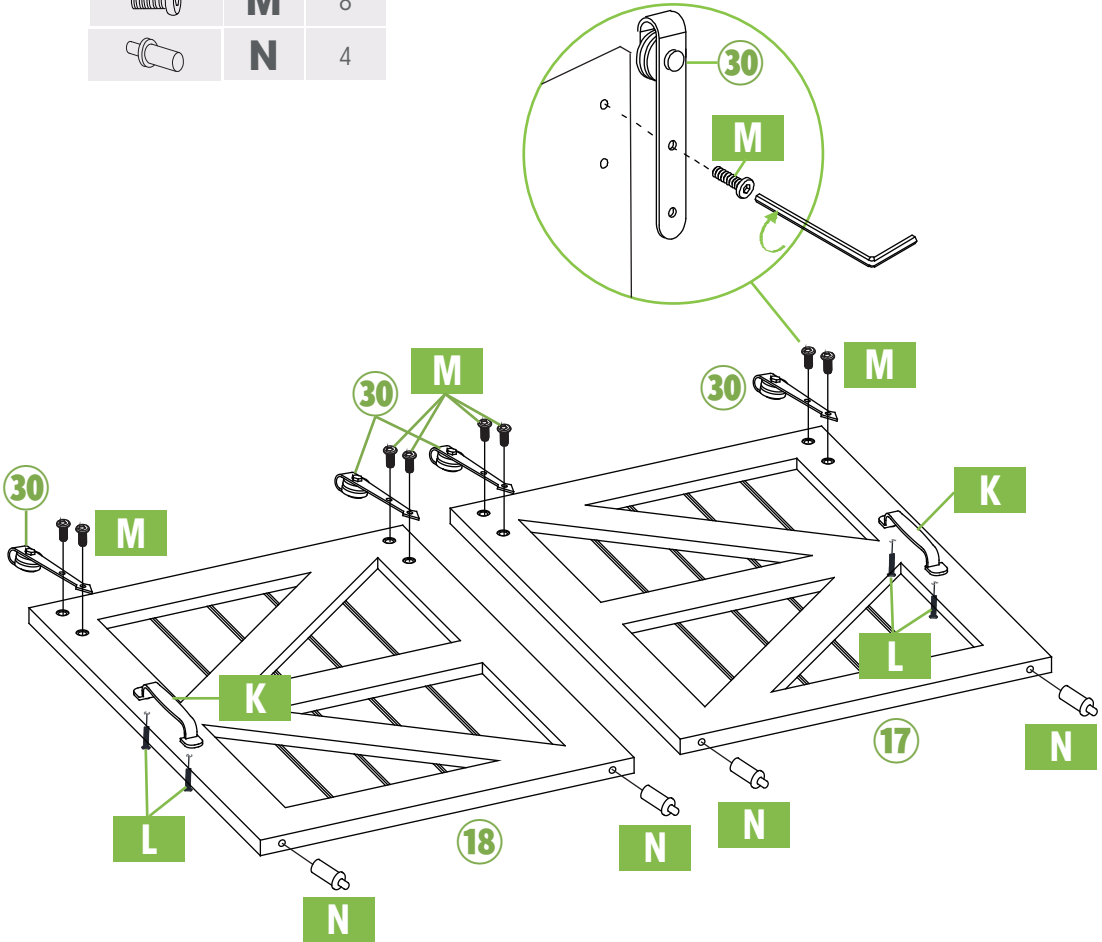

PRODUCT ASSEMBLY

18

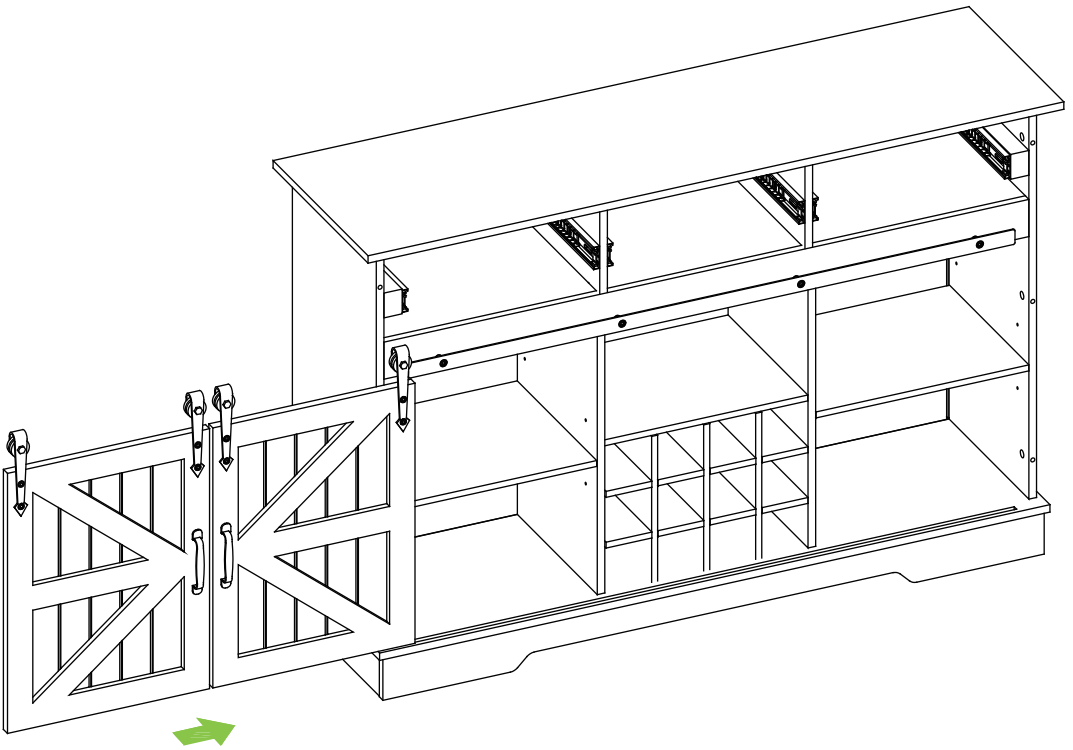

PRODUCT ASSEMBLY

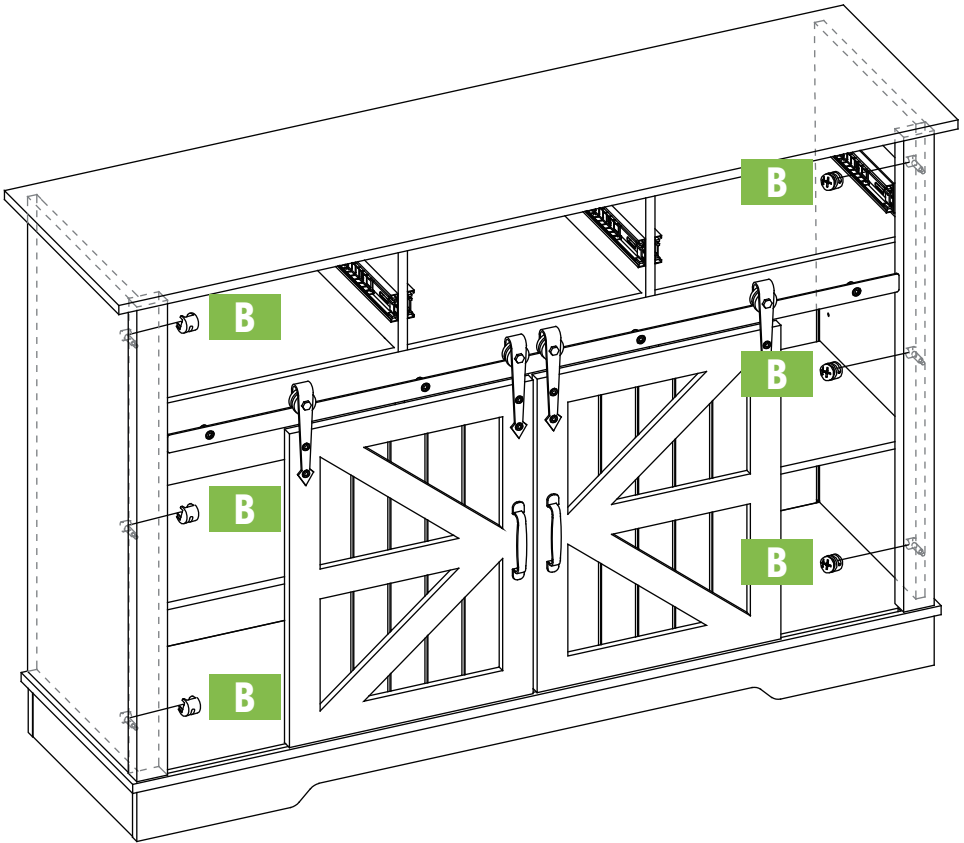

19

PART	NO.	QTY.
	B	6



PRODUCT ASSEMBLY

20

PART	NO.	QTY.
	F	18
	G	6

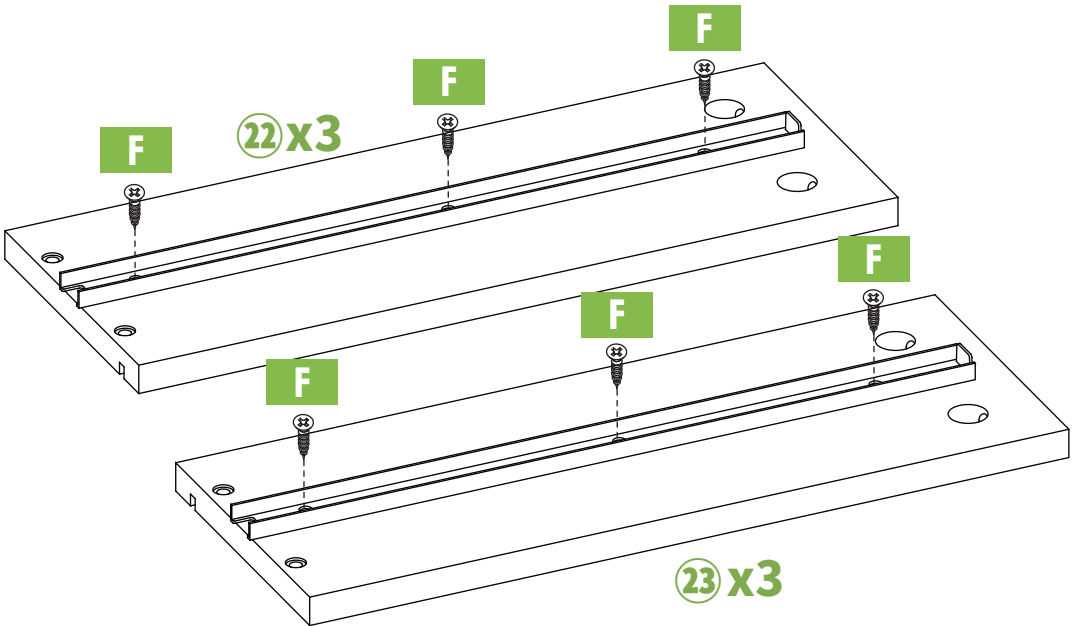
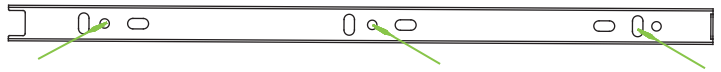

PRODUCT ASSEMBLY

21

PART	NO.	QTY.
		12

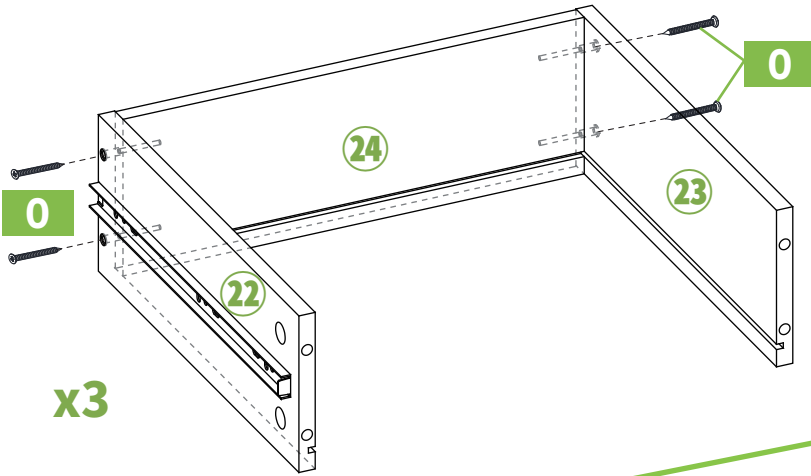

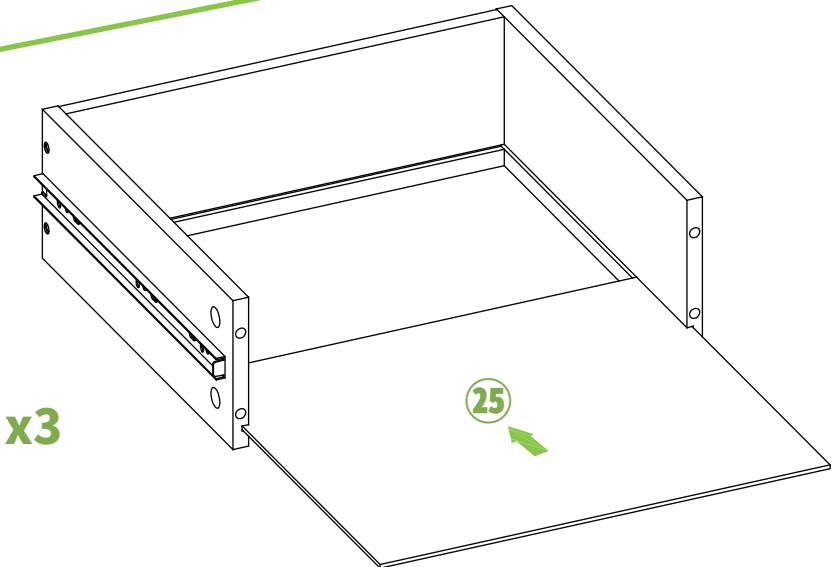

x3



x3

PRODUCT ASSEMBLY

22

PART	NO.	QTY.
	A	12
	L	3
	P	3

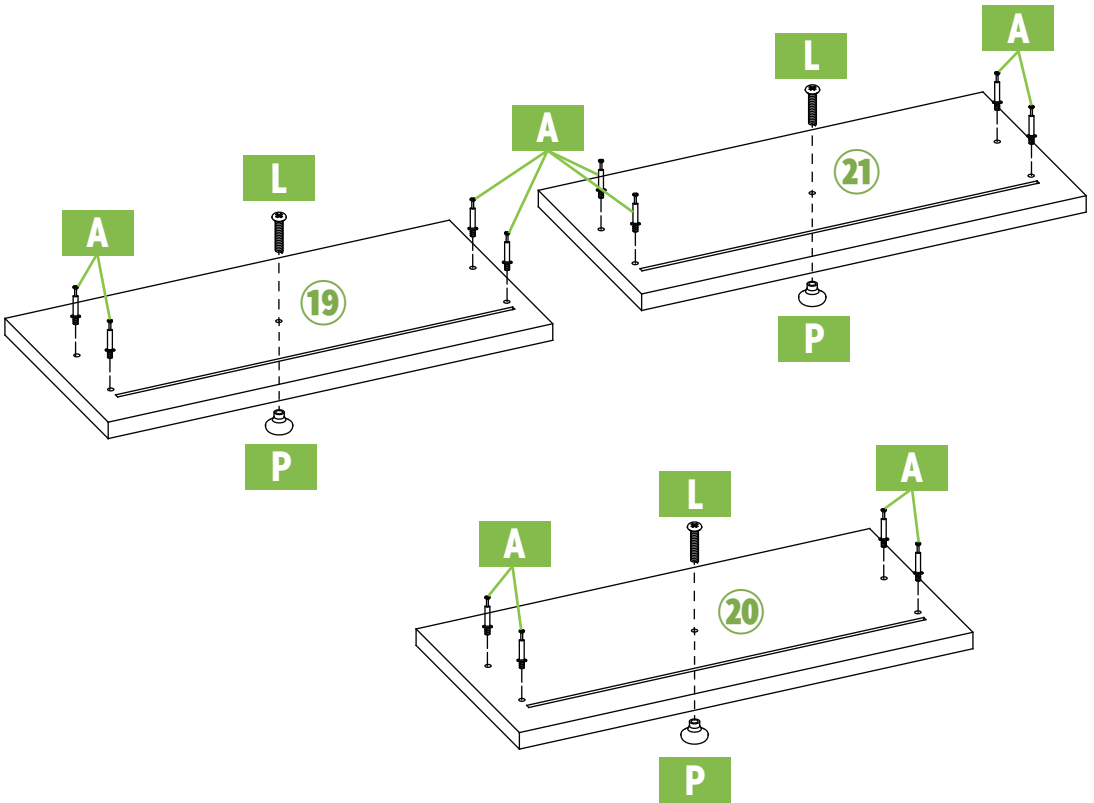

PRODUCT ASSEMBLY

23

PART	NO.	QTY.
	B	12

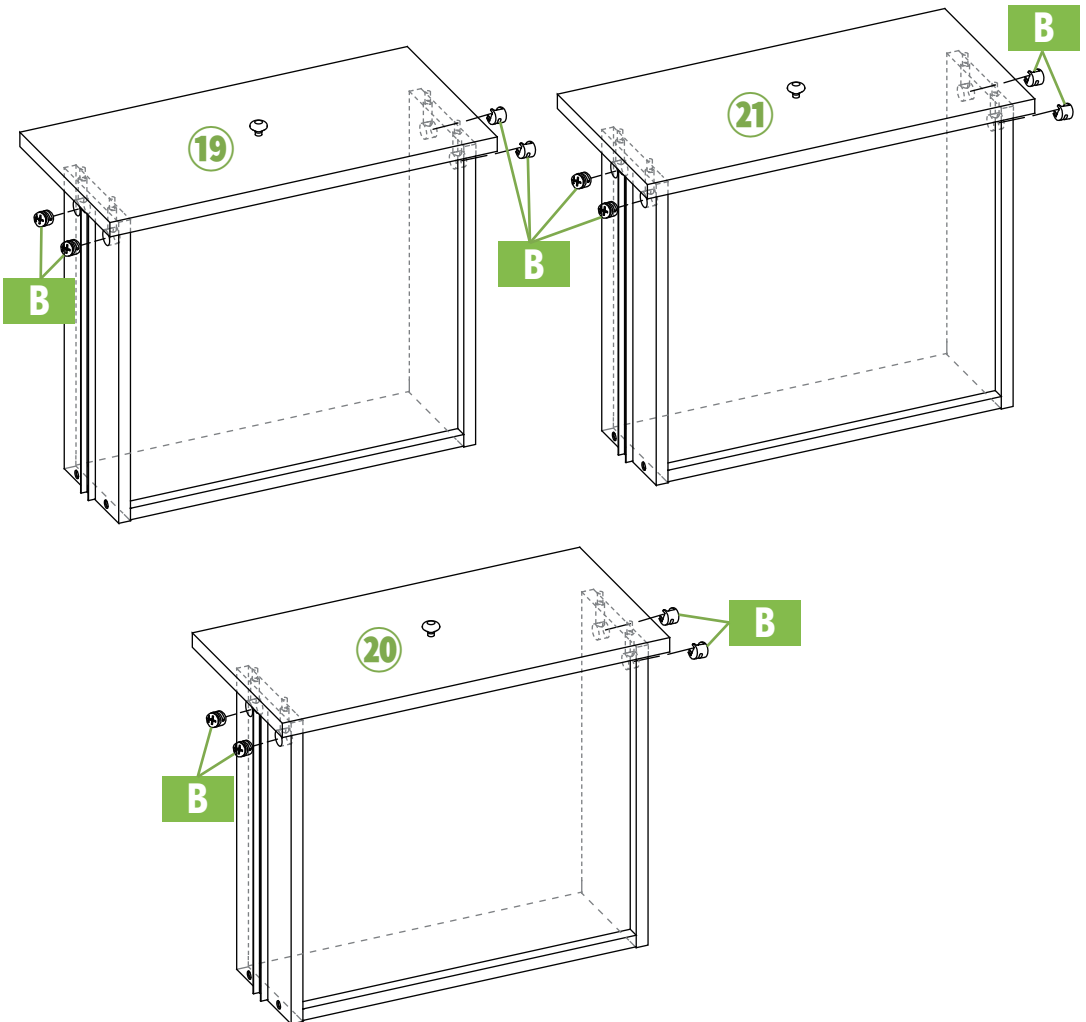

PRODUCT ASSEMBLY

24

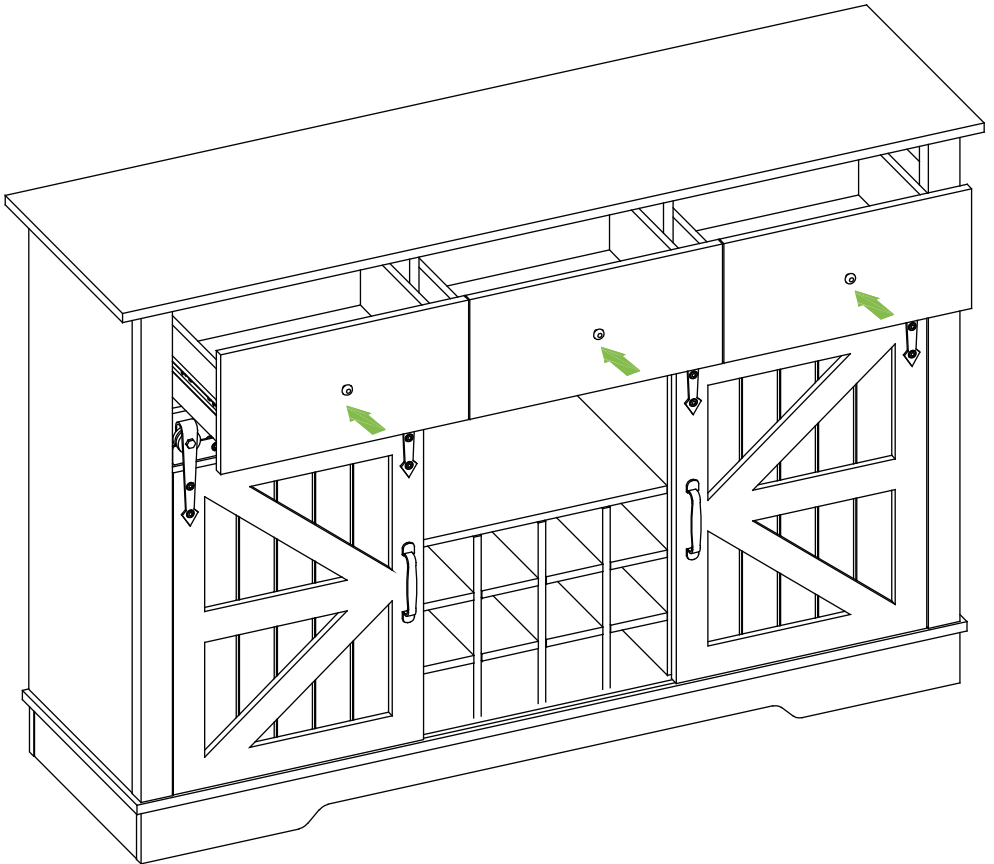

HELP CENTER

Question about your product? We're here to help. Visit us at:

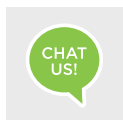

Chat Support

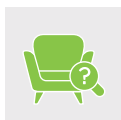

Product Inquiry

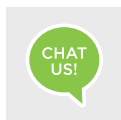

Orders FAQ



Product Assembly



Returns & Refunds

We Stand Behind the Quality of Their Furniture

If you have any issues with your item please let us know! We will always do our best to come up with a solution that you will be happy with.

Please get in touch with our customer service team before returning the product.

And pls do not throw the original box(es) if you have not finished assembling or confirmed no quality issues.

Length of return period:

Items can be returned within 30 days of purchase.

In the meanwhile, everything you purchased from us comes with a one-year warranty.

Who is responsible for the return shipping fee:

We will cover the return shipping fees if:

1. Your item has a manufacturing defect in its materials or workmanship. For example, torn wicker or misaligned screw holes. We will send you a prepaid shipping label after photos are sent.
2. Your item has been damaged in transit. For example, glass is broken or wicker is damaged. We will send you a prepaid shipping label after photos are sent.
3. You receive the wrong box(es) due to a warehouse error. We will send you a prepaid shipping label after photos are sent of the wrong SKU numbers on the outer box(es).
4. One or more boxes are lost in transit. We will send you a prepaid shipping label if you no longer want the item.

* However, we still hope to work with you for a better solution instead of a return. Please don't hesitate to contact our customer service team.

Customer will cover the return shipping fees if:

1. You don't like the product(s) after receiving the box(es).
2. You no longer need the product(s) but you have received the box(es).
3. You buy the product(s) by mistake but you have received the box(es).
4. Order/shipment cancellation failed and you have received the box(es).

Return Request

In order to get a full refund as described in this return policy, all items must be: (1) In a brand new/unused condition, please provide photos before and after packaging. (2) When returning, all accessories and parts are firmly packed in all original packaging.

If your return does not meet the requirements, you may not get a full refund.

When will I be refunded?

The refund is released once the goods have been returned to our warehouse.

What if the product is damaged/defective outside of the valid return period?

We want you to be a happy customer. Please reach out to us by email and we will come up with a solution to make sure you are satisfied.