



# Lustra™ Quick-Release™

## Round-Front Toilet Seat

### K-4662

#### Features

- Solid polypropylene plastic.
- Round closed-front seat with lid.
- Contoured seat for user comfort.
- Color-matched plastic hinges.
- Quick-Release™ hinge caps snap open and seat pulls forward for removal.
- Quick-Attach™ stainless steel fastener allows for top-mount screwdriver only install.



#### Codes/Standards



















IAPMO/ANSI Z124.5

#### KOHLER® One-Year Limited Warranty

See website for detailed warranty information.

#### Available Color/Finishes

*Color tiles intended for reference only.*

Color	Code	Description
	0	White
	W2	Earthen White
	96	Biscuit
	47	Almond
	NY	Dune
	55	Innocent Blush™
	95	Ice™ Grey
	G9	Sandbar
	33	Mexican Sand™
	45	Wild Rose™
	K4	Cashmere
	58	Thunder™ Grey
	52	Navy
	7	Black Black™
	12	Jersey Cream
	17	Teal
	53	Raspberry Puree
	56	Tender Grey
	71	Seafoam Green

USA/Canada: 1-800-4KOHLER (1-800-456-4537)

Kohler Co. reserves the right to make revisions without notice to product specifications.

For the most current Specification Sheet, go to [www.kohler.com](http://www.kohler.com).

2-12-2018 05:05

THE BOLD LOOK  
OF **KOHLER**®

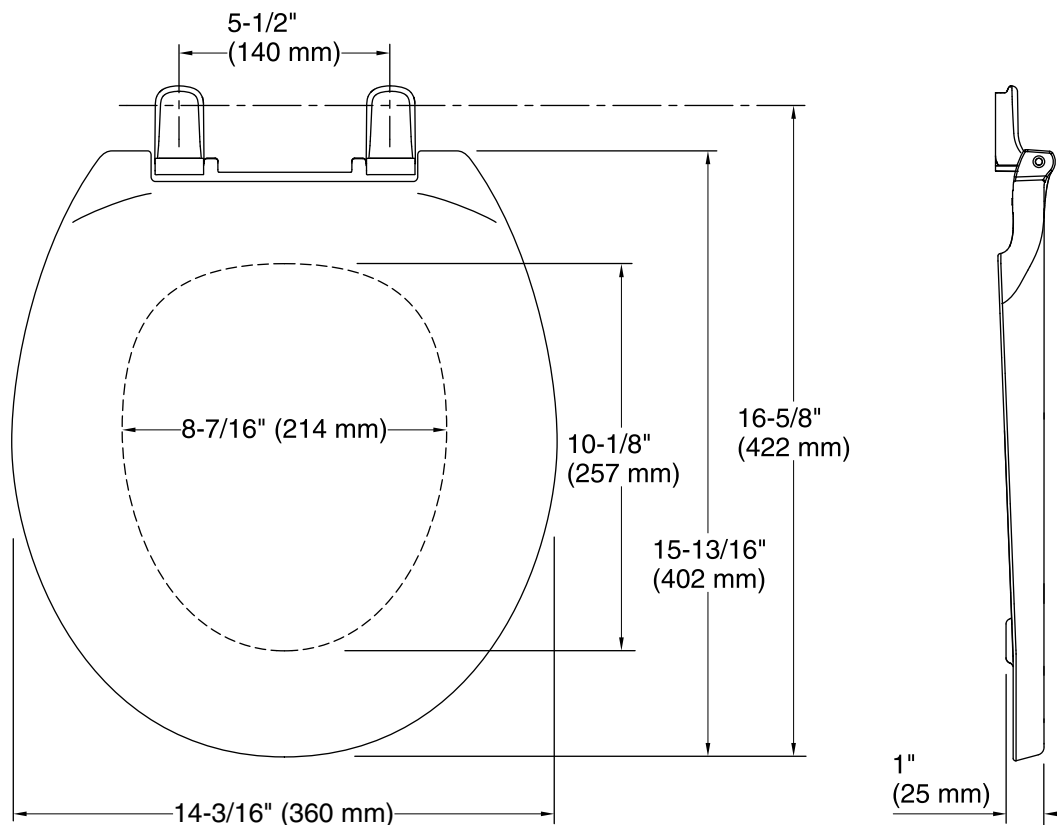

### Technical Information

All product dimensions are nominal.

Seat shape type: Round

Seat front type: Closed front

Seat hinge type: Quick-Attach®, Quick-Release™

Seat-mounting holes: 5-1/2" (140 mm)

### Notes

Install this product according to the installation guide.