

STORAGE SHELTER

2.43X2.43 M
8X8 FT

SKU:D-CW2388G013

ASSEMBLY INSTRUCTIONS

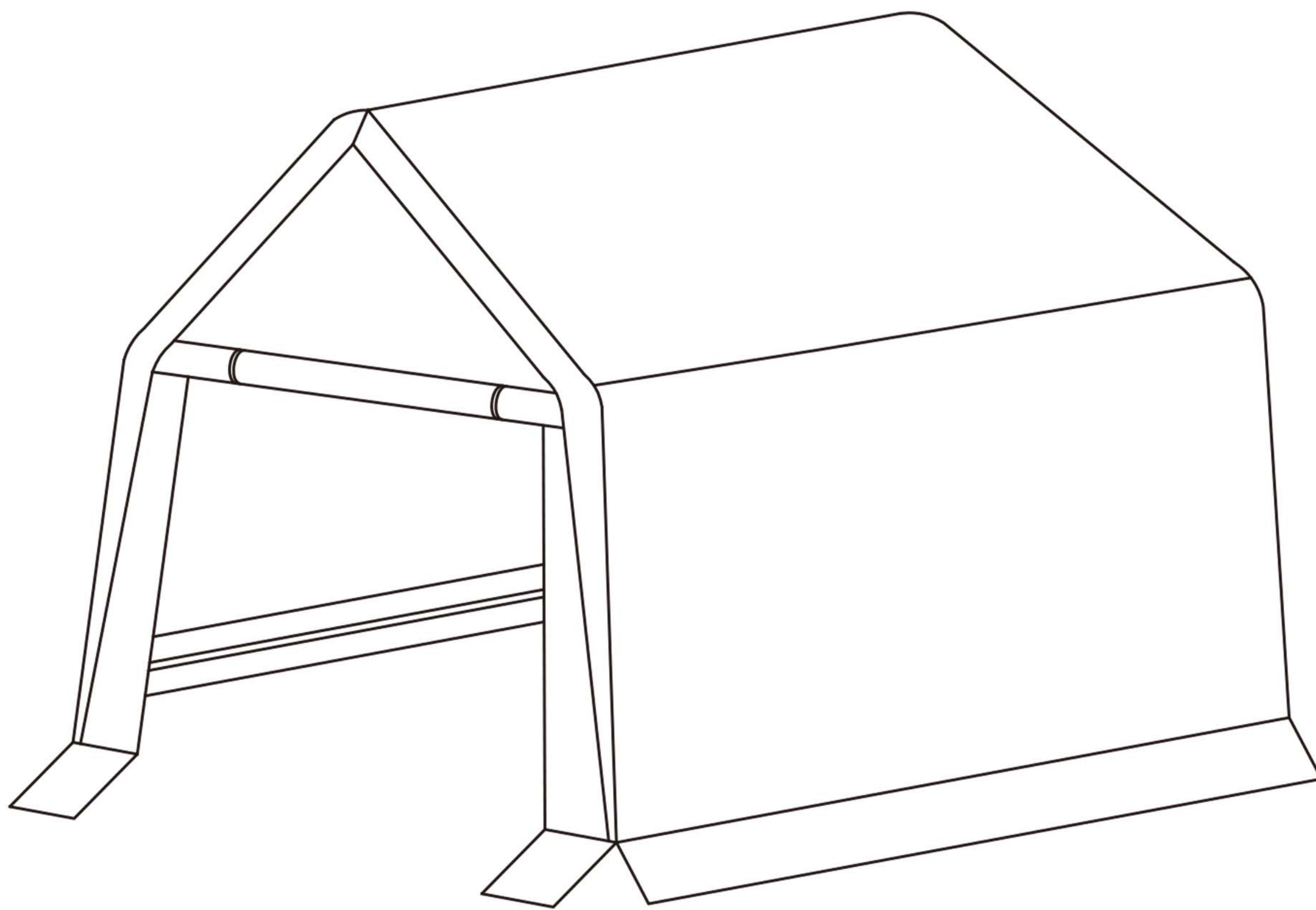

Please check the number of parts in the following accessory catalogue when unpacking. We have sent you more small parts for spare. If there is any missing or any questions about the installation. Please feel free to contact us. We will reply within 24 hours.



E-mail: cs.helper01@gmail.com

TOOLS RECOMMENDED

*NOTE: The recommended tools are not included in boxes and need to be prepared by yourself.

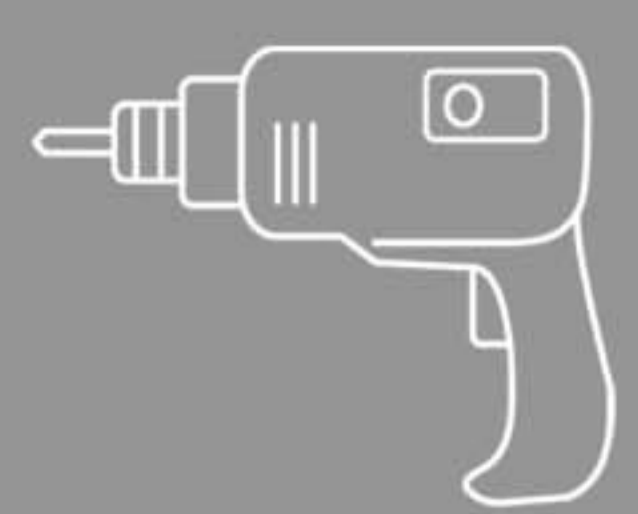

DRILL



RUBBER Mallet



STEPLADDER
(6.5Ft Or More)



SAFETY HAT



GLOVES

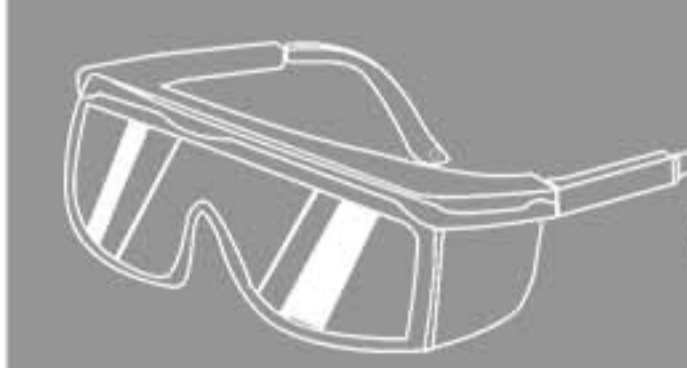

SAFETY GOGGLES

ATTENTIONS



Since it is easy to lose many small accessories during the installation, please collect all the screw accessories before the assembly is completed



To better align the screws for practical situations, do not fully tighten screws initially



Please reinforced the Gazebo and do not use in heavy winds or inclement weather



Make sure all screws are tightened before use and check all screws, buckles and straps every 90 days

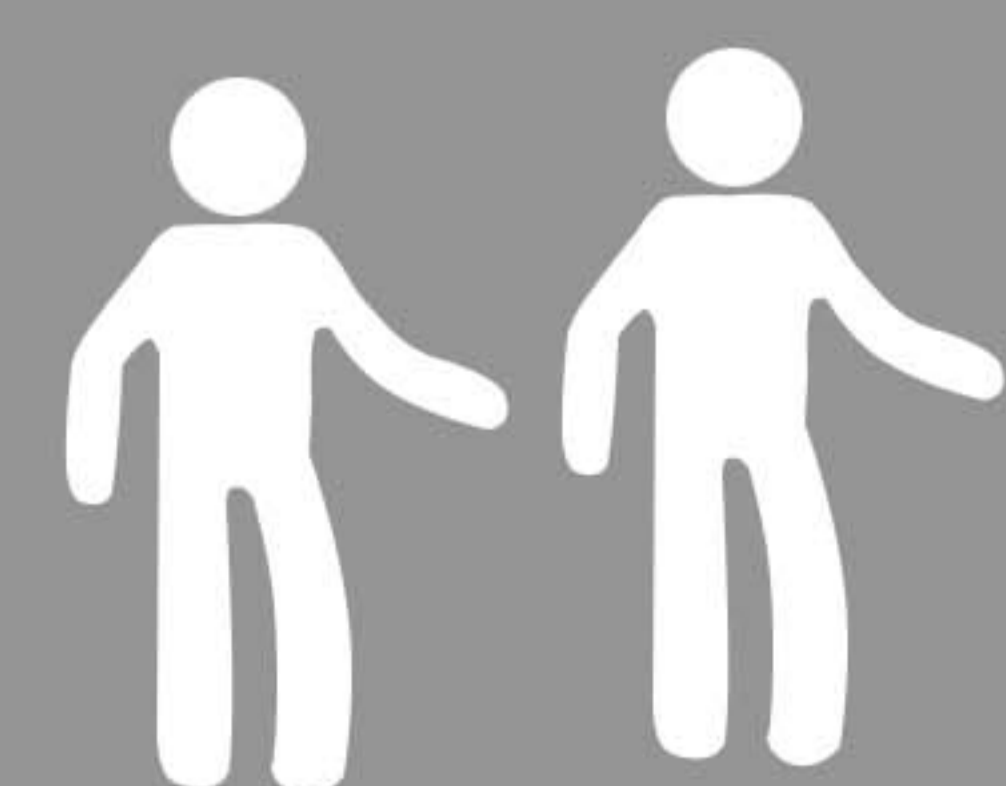

Two or more people are required for assembly



Please clear the snow off the roof in time for the heavy snowfall and do not use it

















Please take care of the screws and contact the after-sales service if there is any problem with the installation or parts.

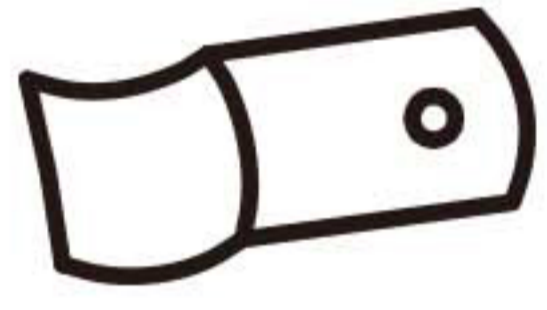

ACCESSORY CATALOGUE

BOX

SKU:D-CW2388G013

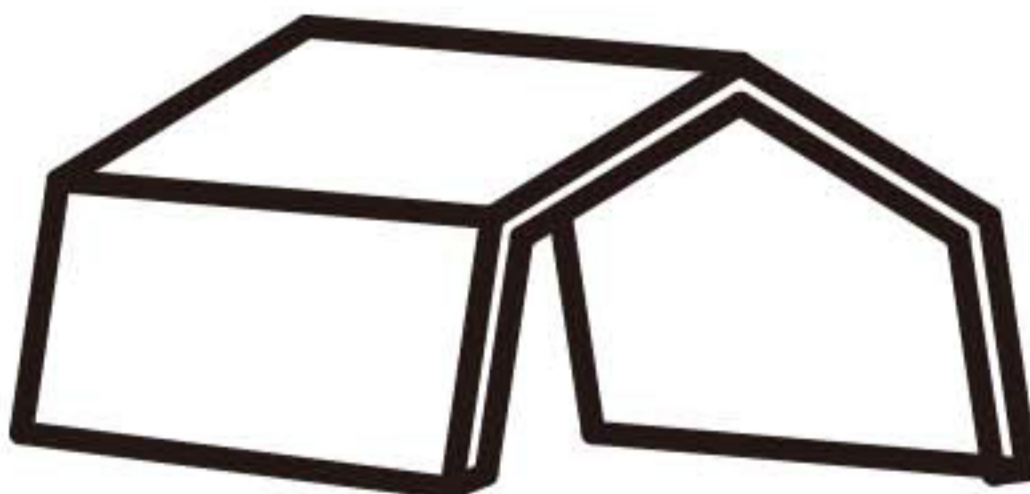
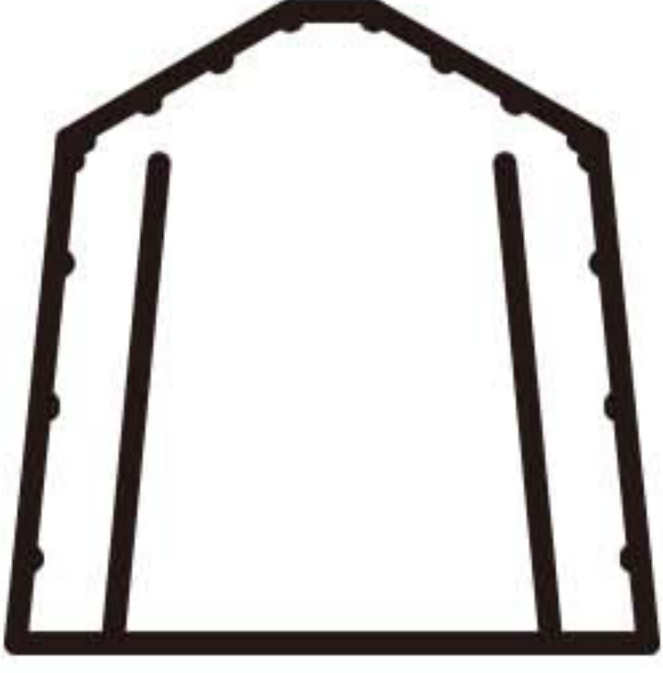
Item no.	Reference Image	Qty.	Item no.	Reference Image	Qty.
1		6	2		6
3		6	3A		6
4		4	A		6
B		3	C		6
D		8	D1		4
E	 $\phi 5 \times 250\text{mm}$	4	F		32
G	 M8 × 50	2	H	 M6 × 40	8
I	 $\phi 4 \times 160$	12	J	 $\phi 5$	4
K		1	K1		1

Please take care of the screws and contact the after-sales service if there is any problem with the installation or parts.

➔ ✉ E-mail: cs.helper01@gmail.com

ACCESSORY CATALOGUE

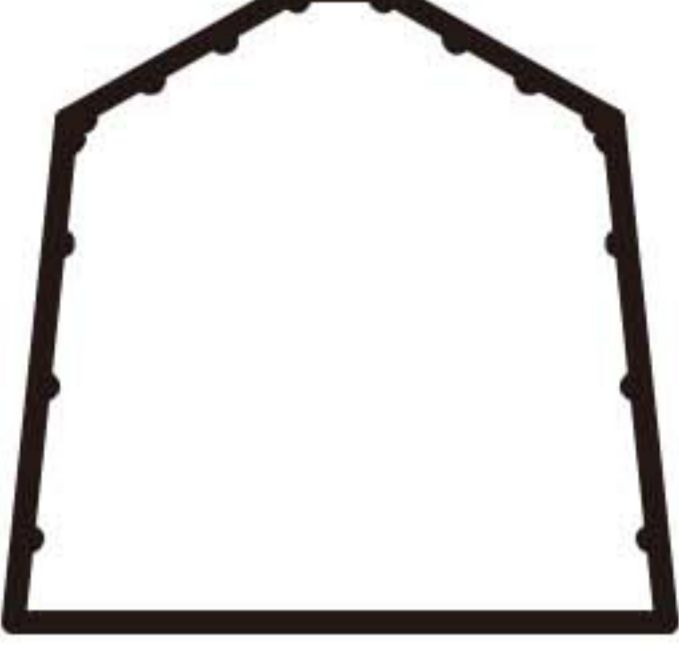
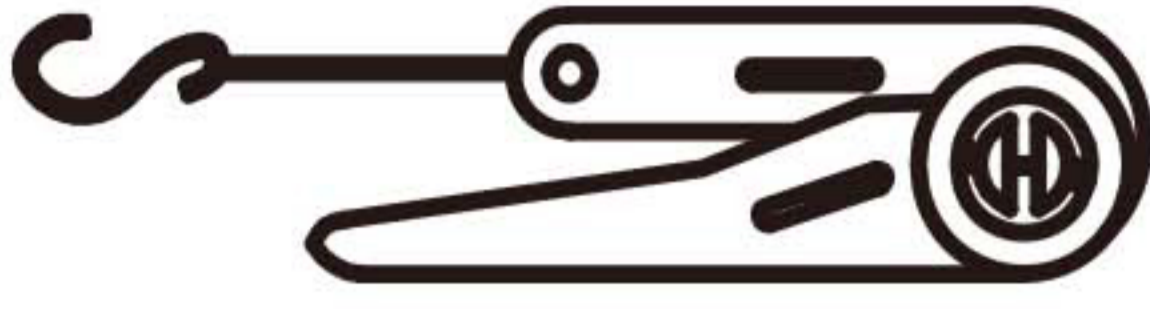
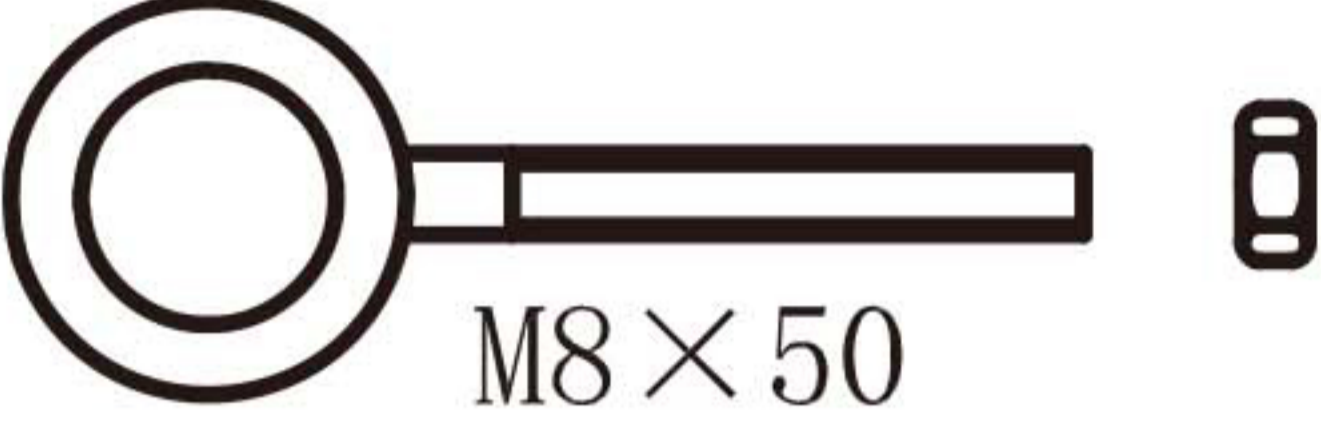
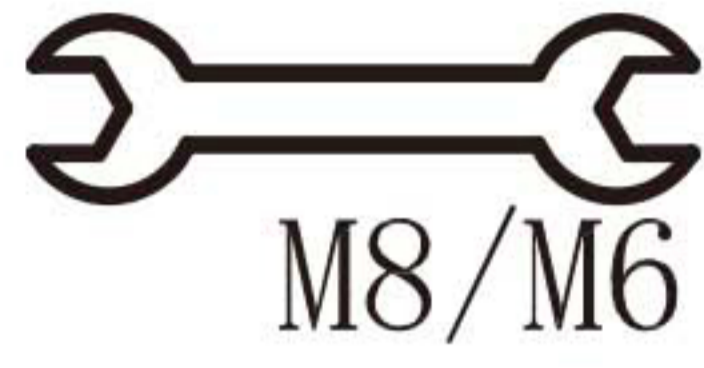
Item no.	Reference Image	Qty.	Item no.	Reference Image	Qty.
K2		1	L		4
M	 M8 x 50	4	N	 M8/M6	2

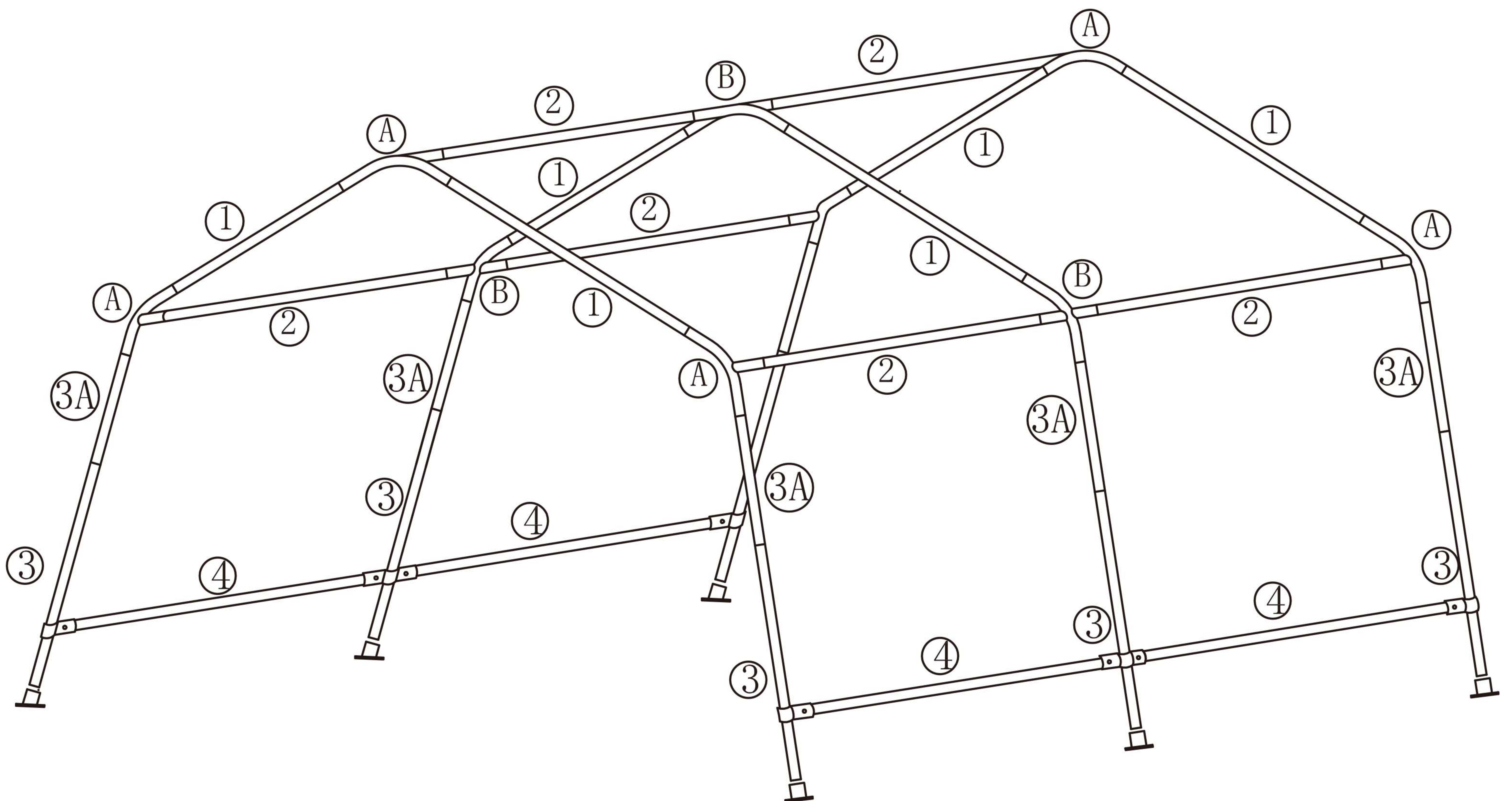

Please take care of the screws and contact the after-sales service if there is any problem with the installation or parts.



STEP 1

Parts required



A 6pcs



1 6pcs



B 3pcs

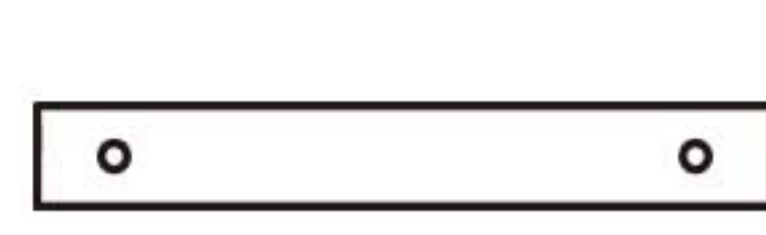

2 6pcs

For convenience, please place each accessory according to the position shown in the figure, and then start to build.

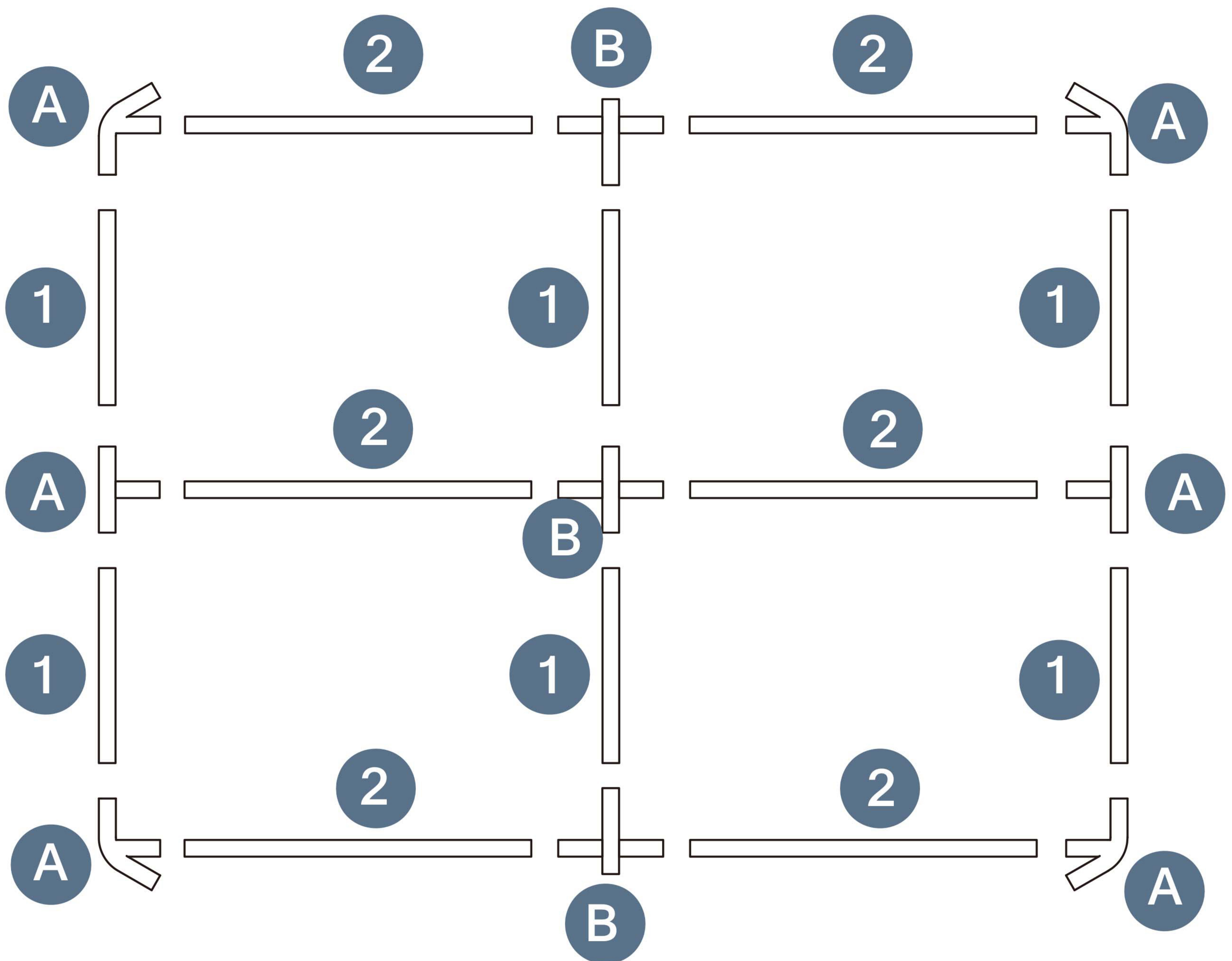

Please take care of the screws and contact the after-sales service if there is any problem with the installation or parts.

➔ ✉ E-mail: cs.helper01@gmail.com

STEP 2

Parts required



A 6pcs



1 6pcs



B 3pcs



2 6pcs

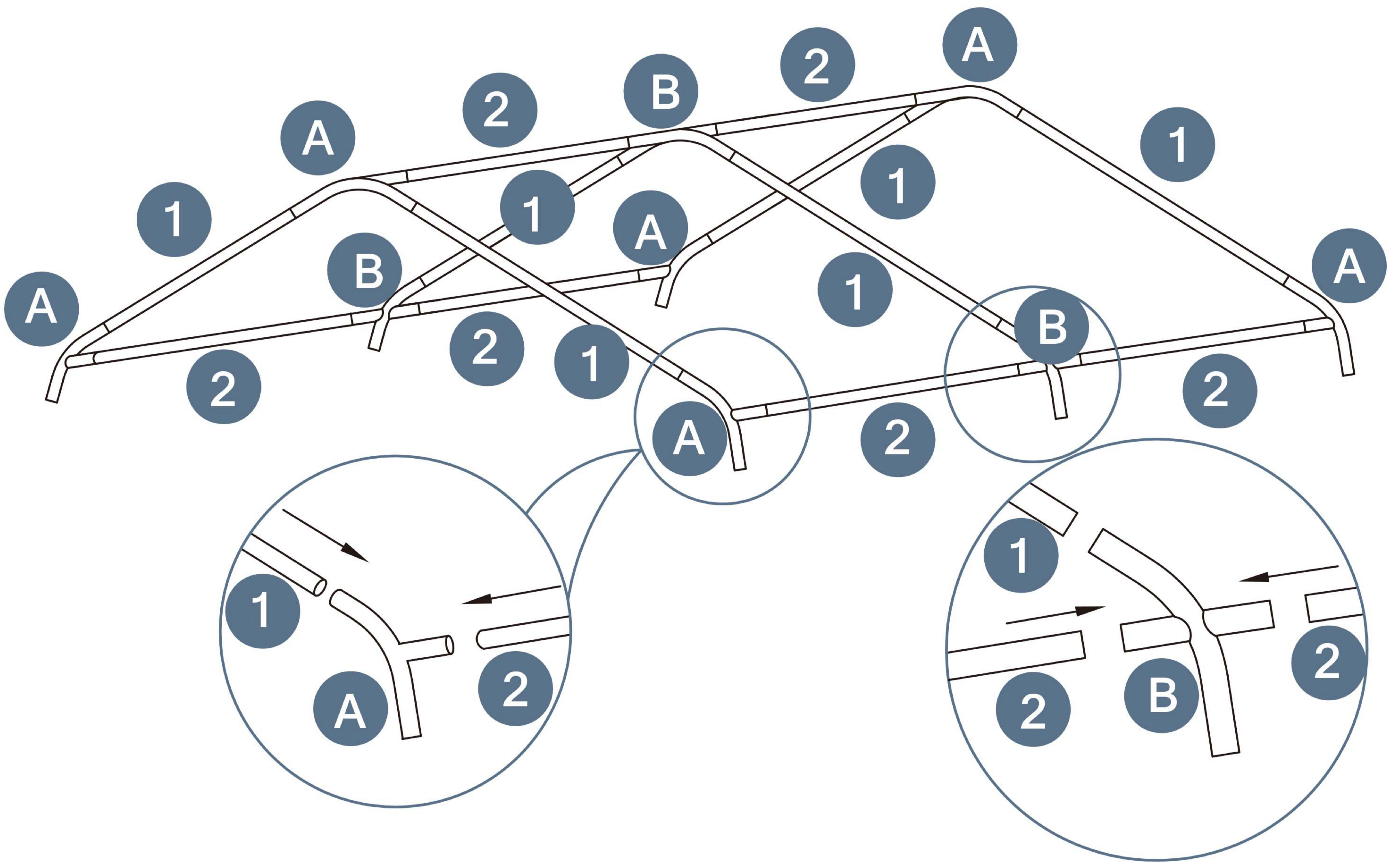

Please take care of the screws and contact the after-sales service if there is any problem with the installation or parts.

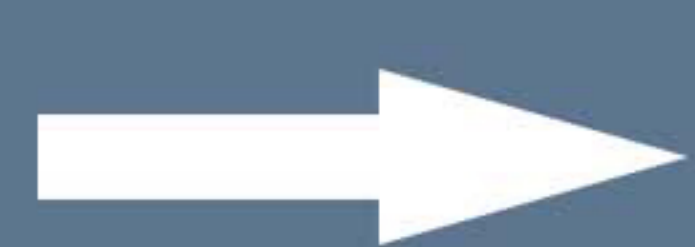

STEP 3

Parts required



3A 6pcs

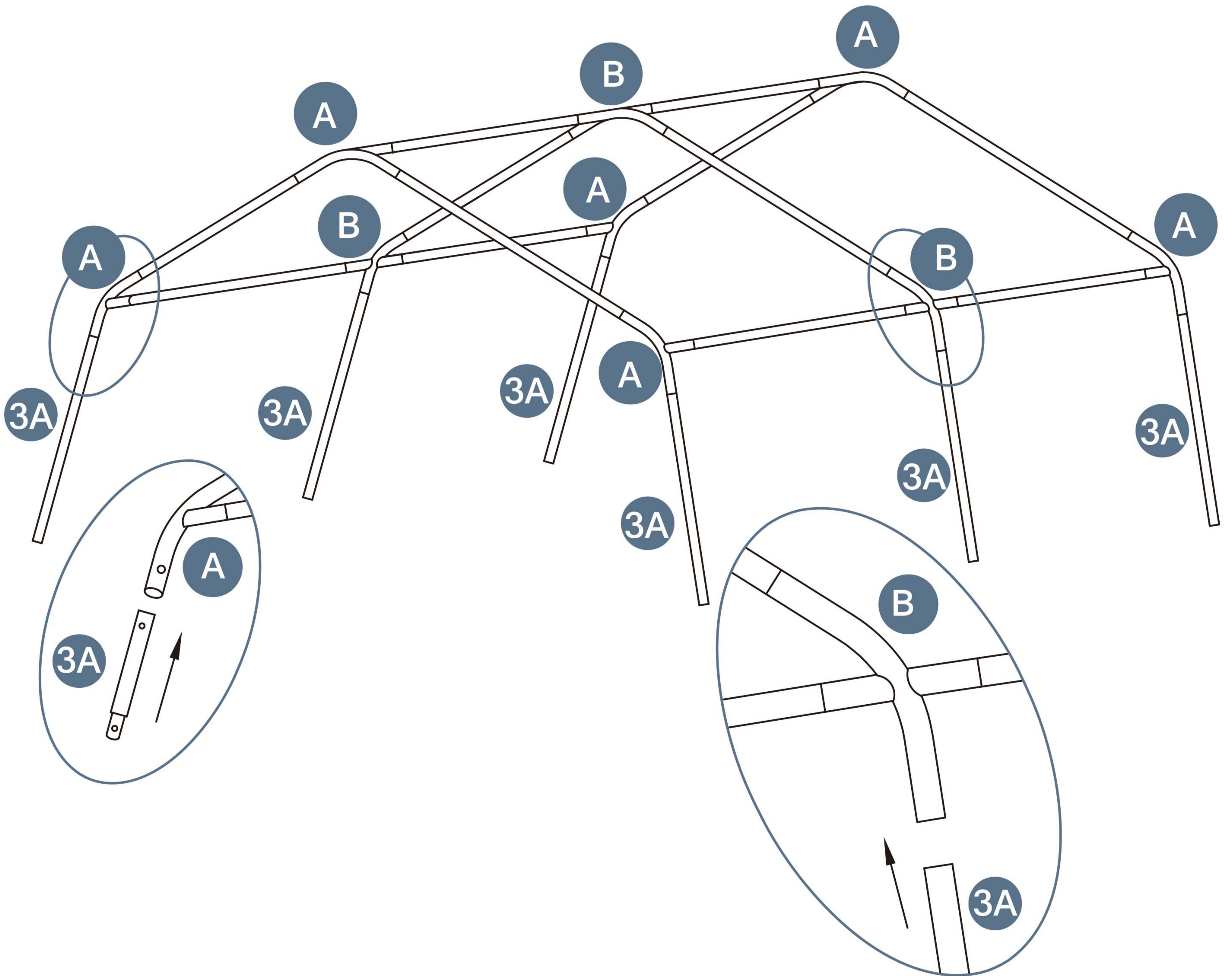

Please take care of the screws and contact the after-sales service if there is any problem with the installation or parts.

➔ ✉ E-mail: cs.helper01@gmail.com

STEP 4

Parts required

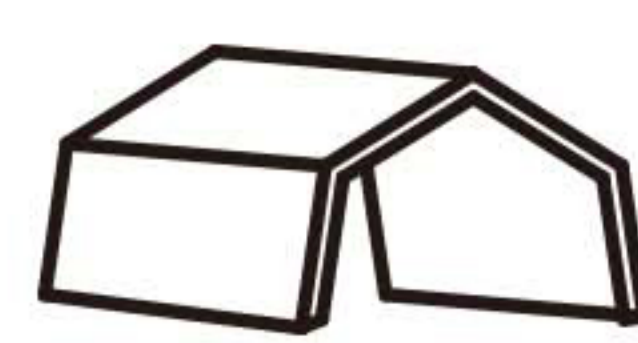

K 1pcs

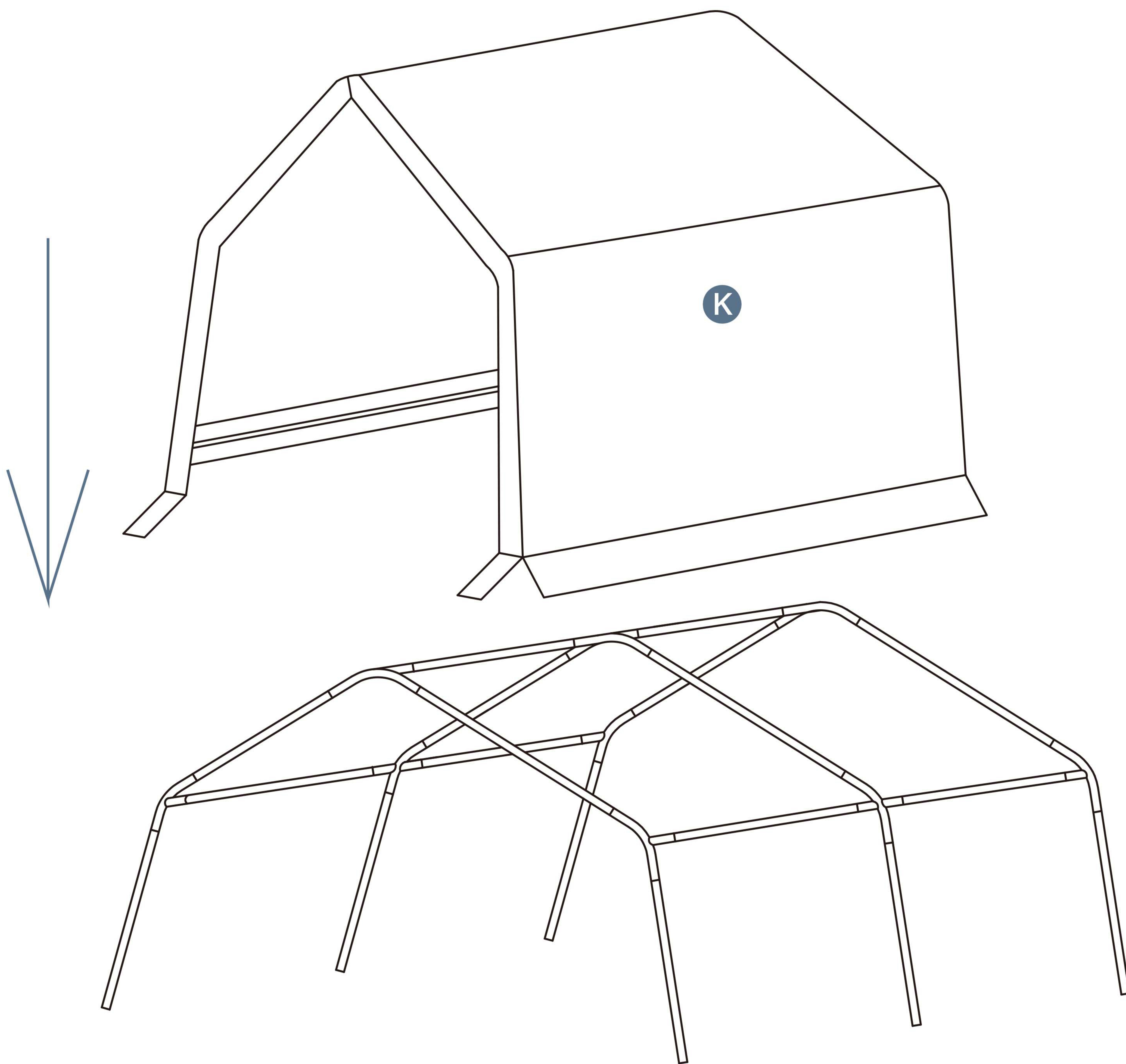

Please take care of the screws and contact the after-sales service if there is any problem with the installation or parts.

STEP 5

Parts required

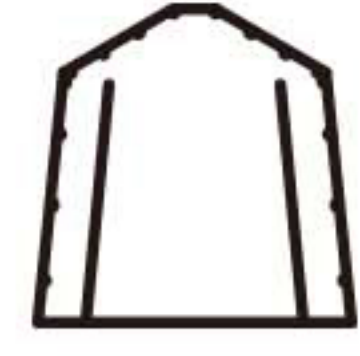

K1 1pcs

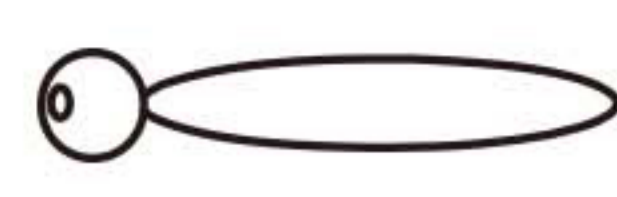

F 16pcs

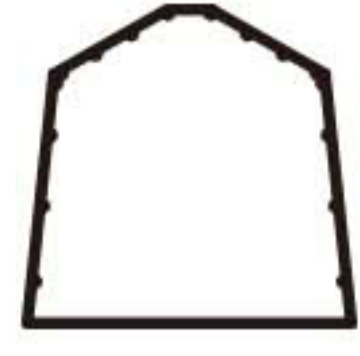

K2 1pcs

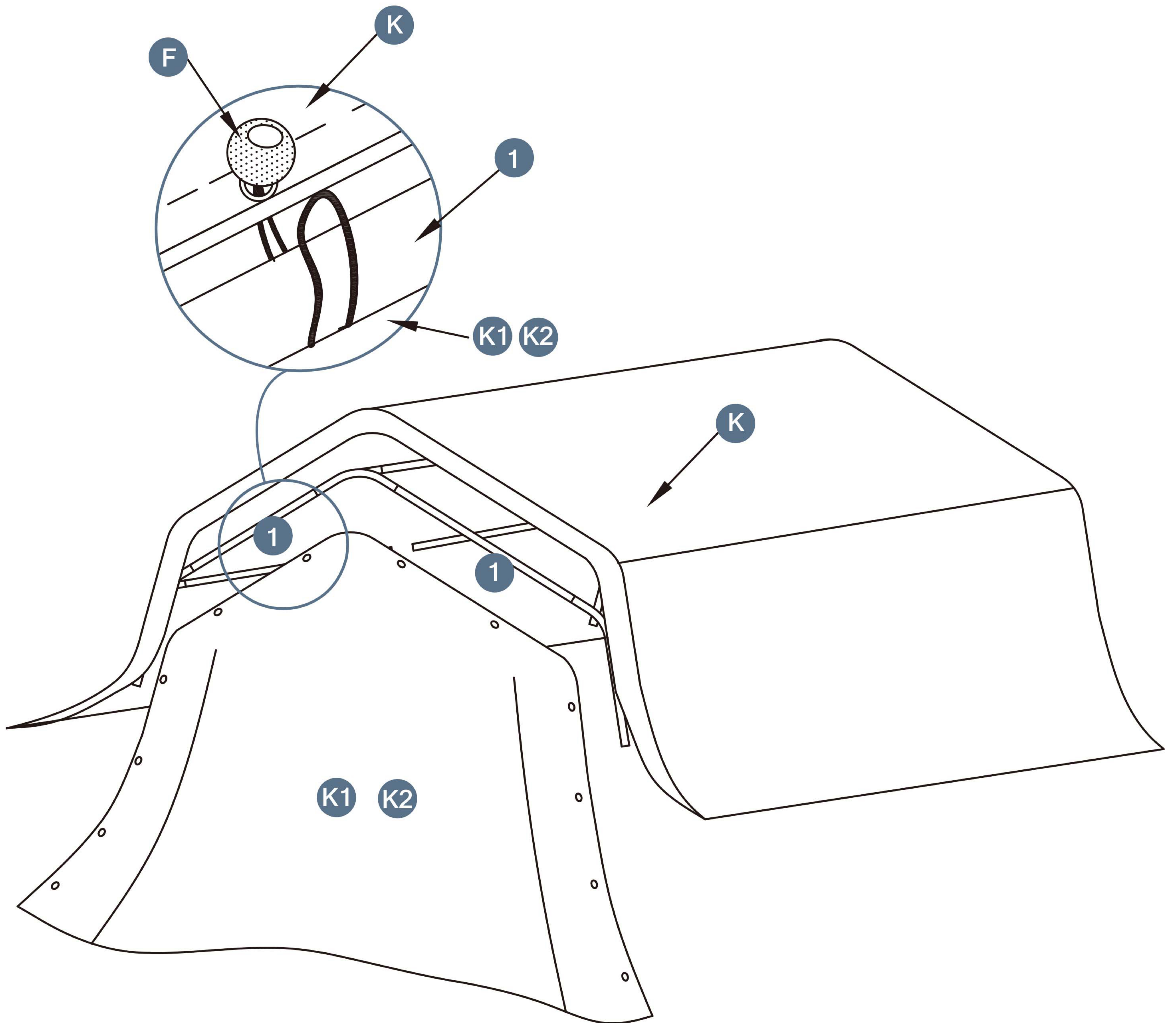

Please take care of the screws and contact the after-sales service if there is any problem with the installation or parts.

➔ ✉ E-mail: cs.helper01@gmail.com

STEP 6

Parts required



3 6pcs

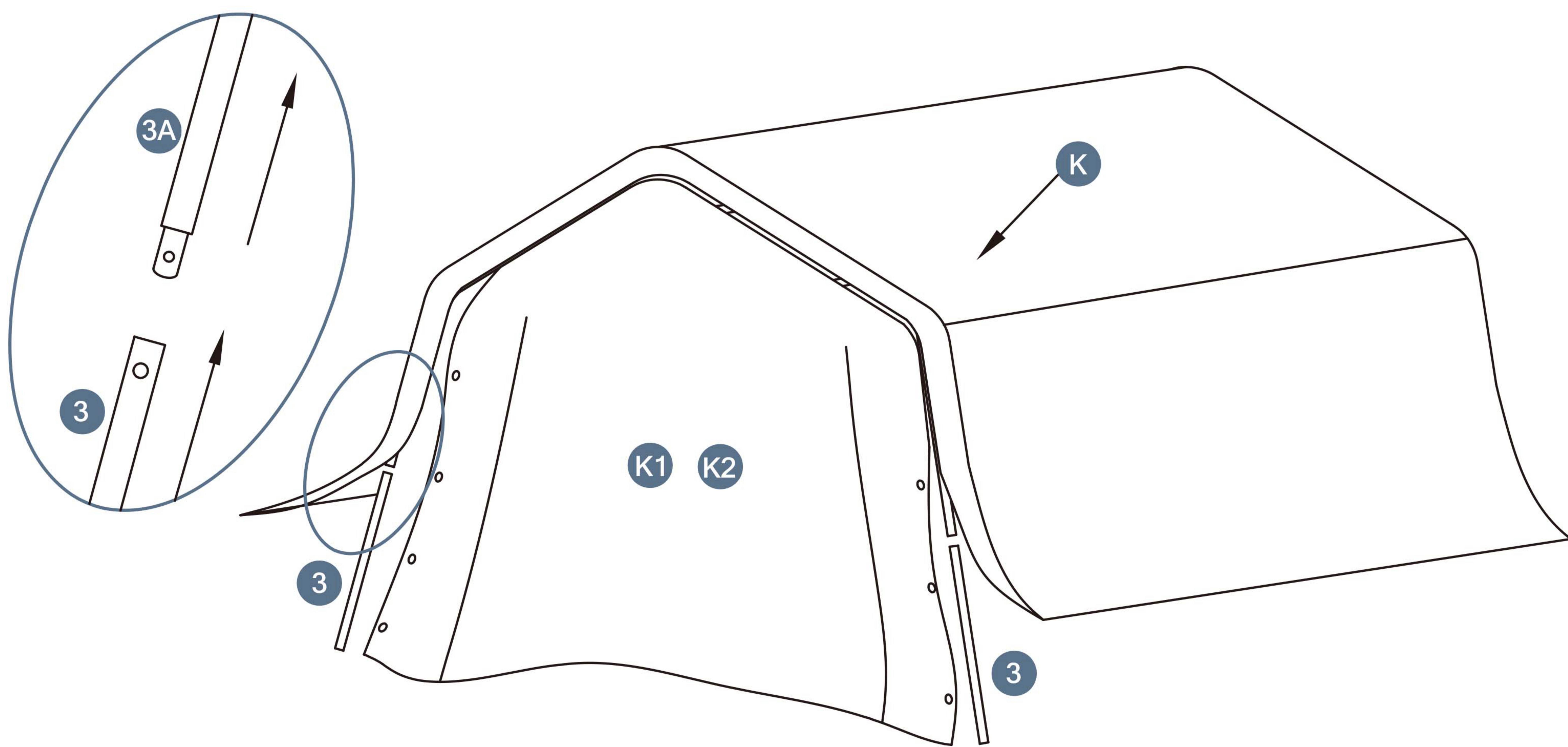

Please take care of the screws and contact the after-sales service if there is any problem with the installation or parts.

STEP 7

Parts required

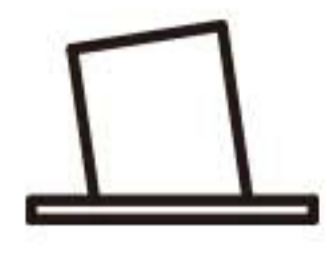

C 6pcs



F 16pcs

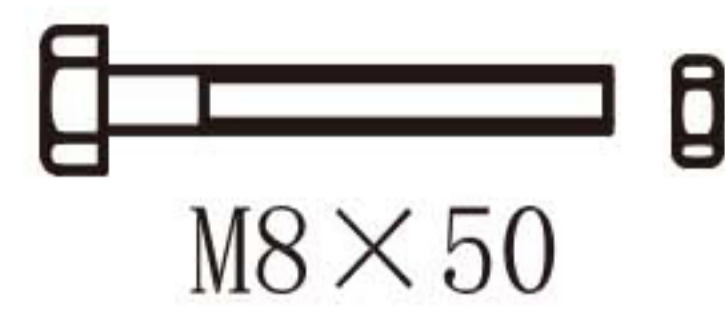

G 2pcs



M 4pcs

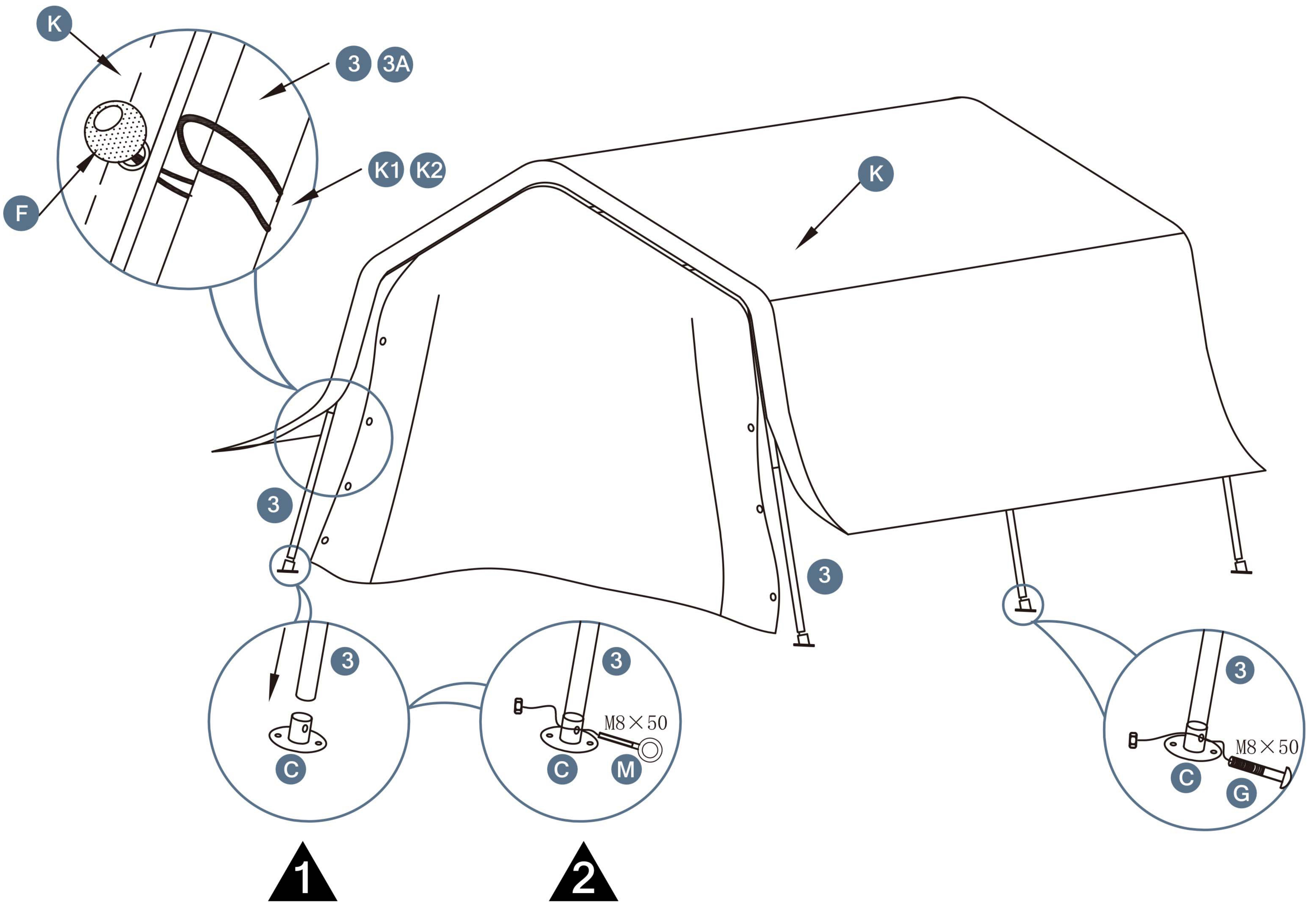

Please take care of the screws and contact the after-sales service if there is any problem with the installation or parts.

➔ ✉ E-mail: cs.helper01@gmail.com

STEP 8

Parts required

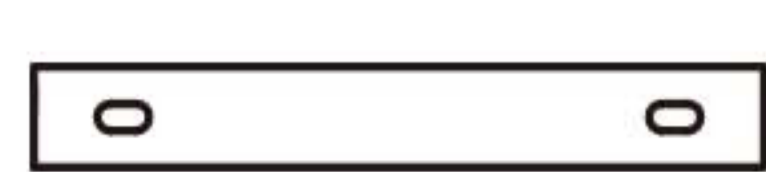

4 4pcs



H 8pcs



D 8pcs



D1 4pcs

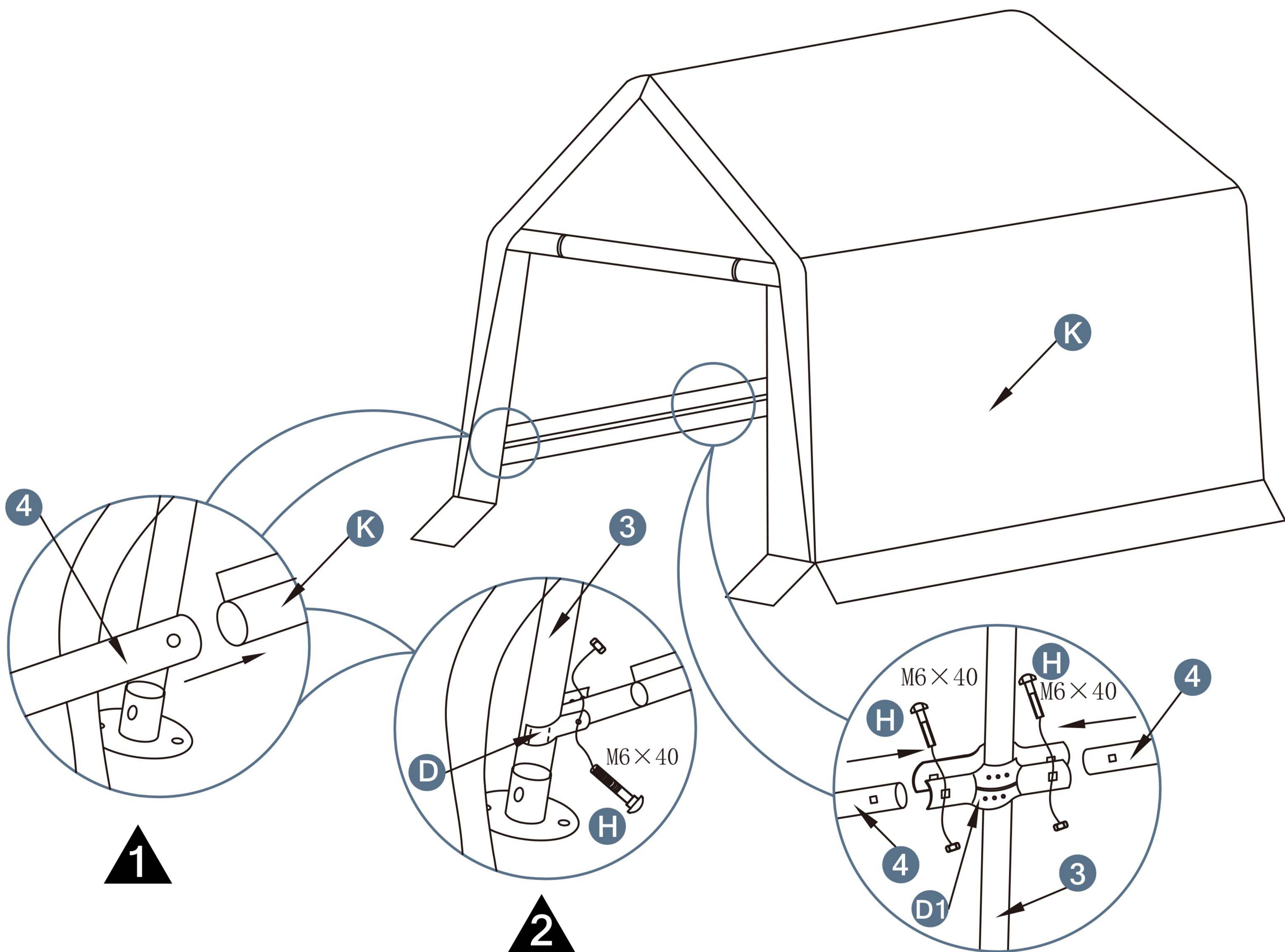

Please take care of the screws and contact the after-sales service if there is any problem with the installation or parts.

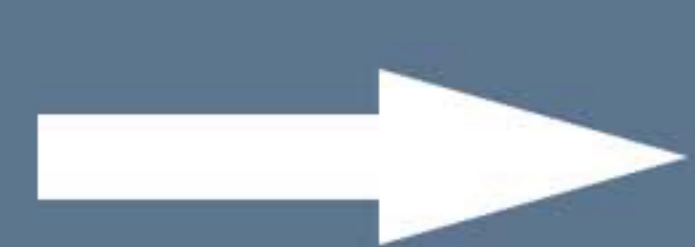

E-mail: cs.helper01@gmail.com

STEP 9

Parts required

 **L** 4pcs

 **M** 4pcs

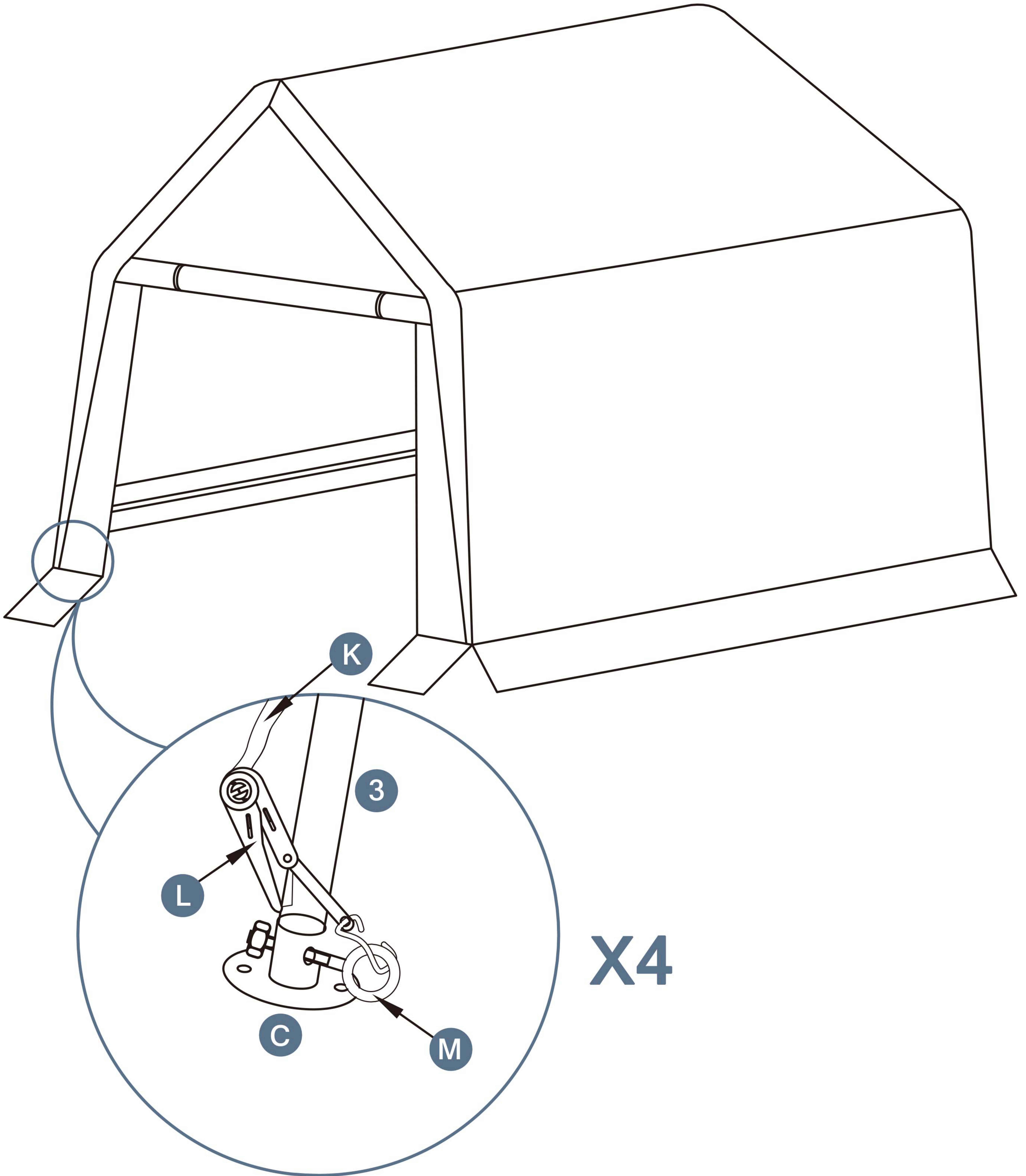

Please take care of the screws and contact the after-sales service if there is any problem with the installation or parts.

➔ ✉ E-mail: cs.helper01@gmail.com

STEP 10

Parts required

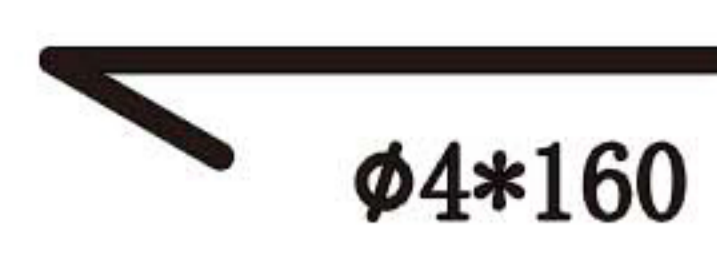

I 12pcs

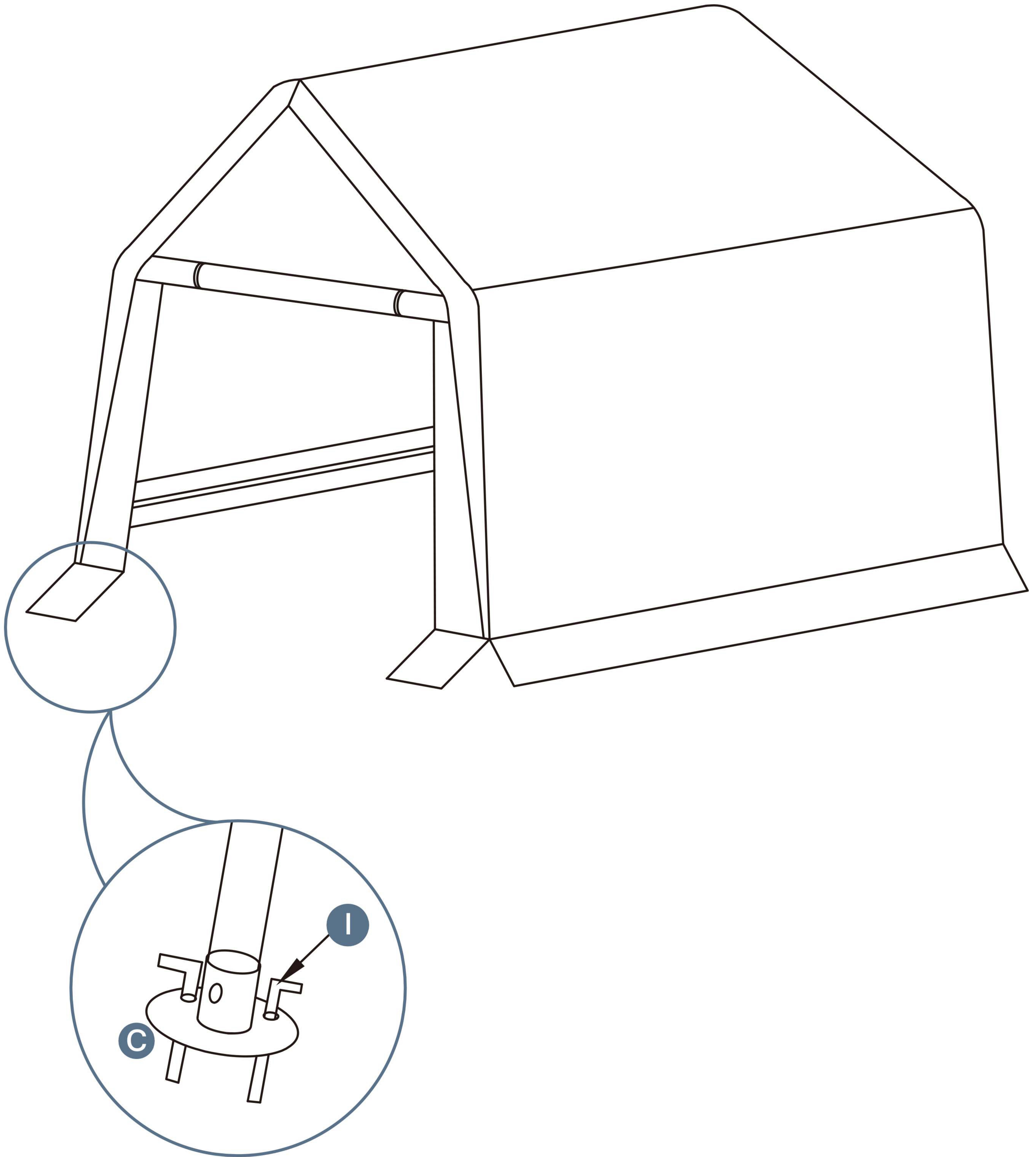

Please take care of the screws and contact the after-sales service if there is any problem with the installation or parts.



STEP 11

Parts required

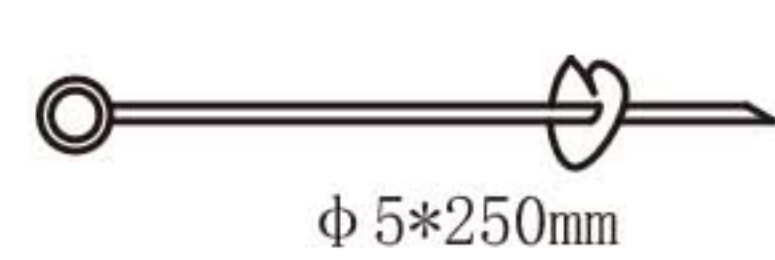

E 4pcs

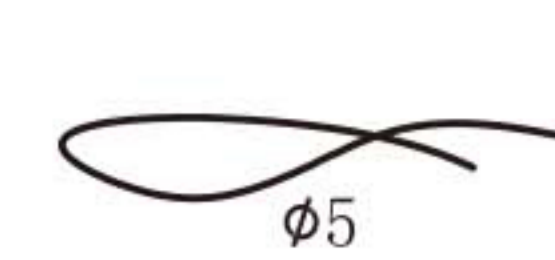

J 4pcs

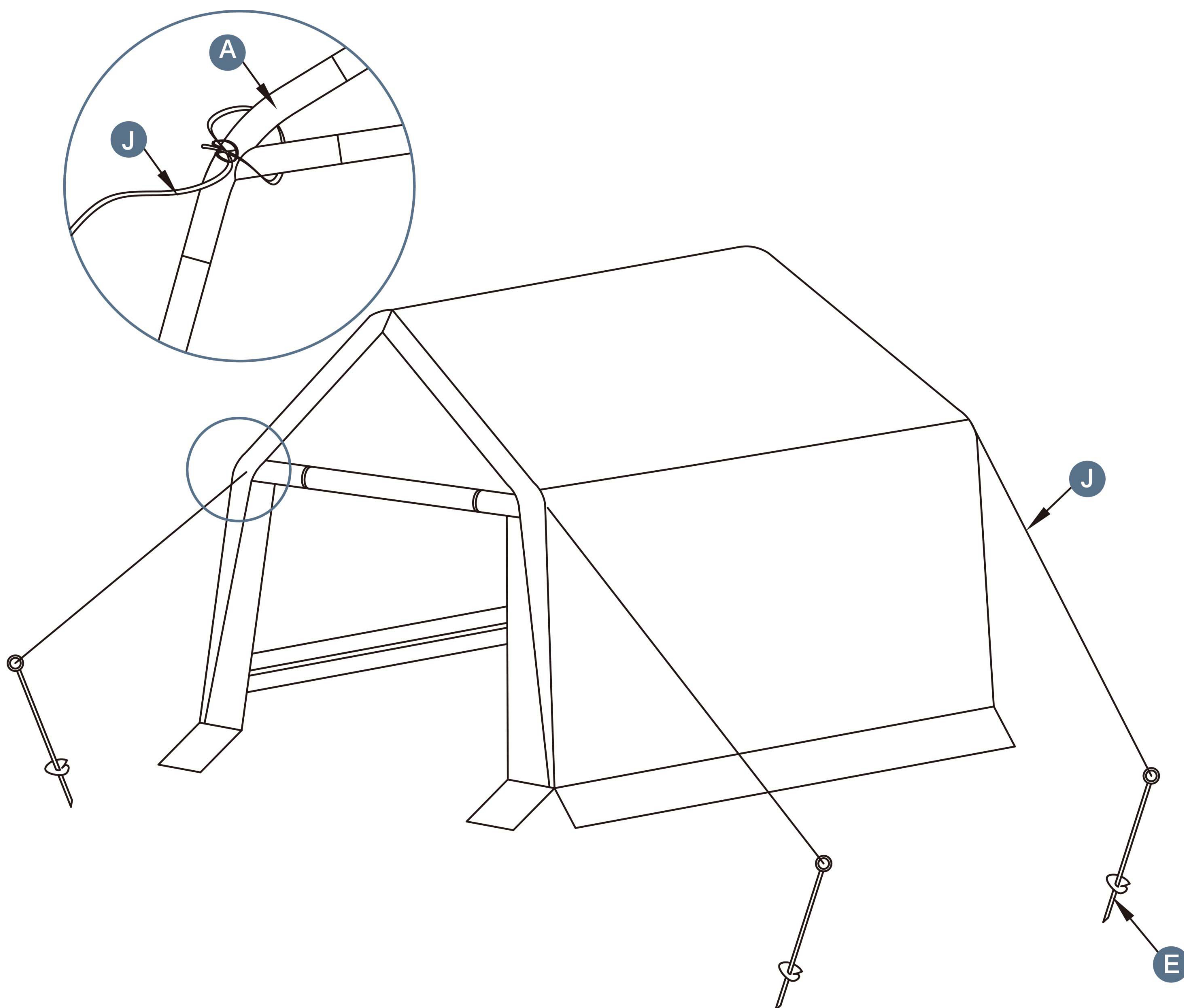

Please take care of the screws and contact the after-sales service if there is any problem with the installation or parts.

➔ ✉ E-mail: cs.helper01@gmail.com

Hope you enjoy this product.

If you have any concerns about gazebo Installation, please feel free to contact us. We will reply within 24 hours.



E-mail: cs.helper01@gmail.com