



### Features

- End drain.
- Slotted overflow for deep soaking.
- Integral lumbar support and armrests for comfort.
- Coordinates with other products in the Archer® collection.
- 66" (1676 mm) x 32" (813 mm) x 19" (483 mm)

### Material

- Acrylic

### Hydrotherapy

- 120 BubbleMassage™ airjets.
- Automatic purge cycles remove residual water from air channels after use.
- Built-in 300 W heater.
- Electronic keypad control.

### Installation

- Drop-in

### Required Accessories

K-7271 Brass Slotted Overflow Bath Drain

or

K-7272 PVC Slotted Overflow Bath Drain

### Recommended Accessories

K-1446 Remote Installation Kit

K-24916 Wireless Music Kit



ADA

### Codes/Standards

ASME A112.19.7/CSA B45.10

CSA B45.5/IAPMO Z124

UL 1795

Greenguard UL 2818 - Gold

ADA

ICC/ANSI A117.1

### KOHLER® Plastic Baths and Receptors

#### Lifetime Limited Warranty









#### KOHLER® Hydrotherapy Components

#### Five-Year Limited Warranty

See website for detailed warranty information.

### Available Color/Finishes

*Color tiles intended for reference only.*

Color	Code	Description
	0	White
	96	Biscuit
	47	Almond
	NY	Dune
	95	Ice™ Grey
	G9	Sandbar
	K4	Cashmere
	58	Thunder™ Grey

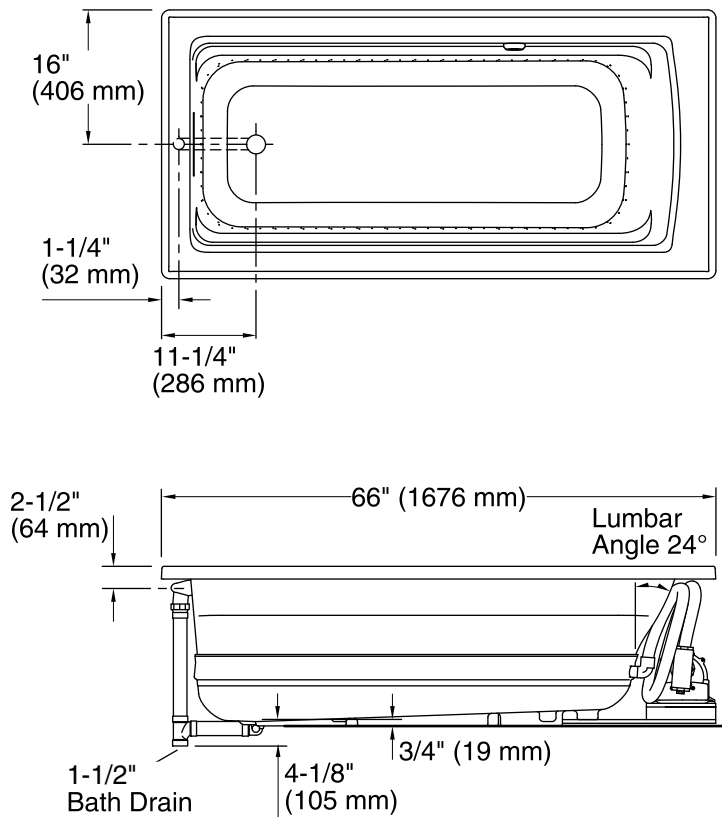

No change in measurements if connected with drain illustrated. (K-7271 or K-7272)

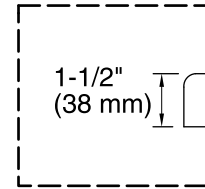

Drop-in Rim Detail

Blower Motor Access  
20" (508 mm) W x 15" (381 mm) H

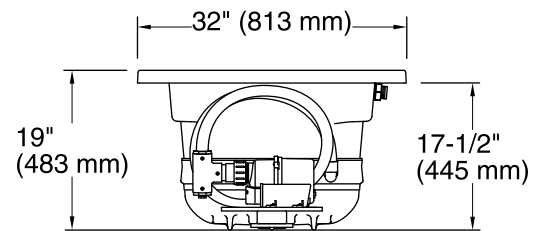

### Required Electrical Service

One dedicated circuit required, protected with Class A Ground-Fault Circuit-Interrupter (GFCI) or Residual Current Device (RCD).

Blower: 120 V, 15 A, 60 Hz

### Technical Information

All product dimensions are nominal.

Installation:	Drop-in
Drain location:	End
Basin area, bottom:	50-3/8" x 19-5/8" (1280 mm x 498 mm)
Basin area, top:	57-5/16" x 24-1/16" (1456 mm x 611 mm)
Weight:	106 lbs (48.1 kg)
Minimum floor load:	47 lbs/ft <sup>2</sup> (229.5 kg/m <sup>2</sup> )
Water depth:	15-5/16" (389 mm)
Water capacity:	66 gal (249.8 L)
Cutout:	Drop-in, 64-1/2" x 30-1/2" (1638 mm x 775 mm)
Electrical component rating:	Blower: 120 V, 10 A, 60 Hz
Minimum flat for door:	2-3/16" (55 mm)

### Notes

Measure your actual product for rough-in details. Install this product according to the installation instructions.

The hot water supply should be 70% of the capacity of the bath or greater. Installations will vary.

This product is designed for drop-in installation only. It is not suited for use in a three-wall alcove with an overhead shower.

Remote blower installation kit K-1446 is available for relocating the blower. Provide access for servicing the blower.

Do not relocate or alter the PVC tee or coiled flexible tubing connected to the blower. Follow the blower relocation instructions exactly.

ADA compliant when installed to the specific requirements of these regulations.