

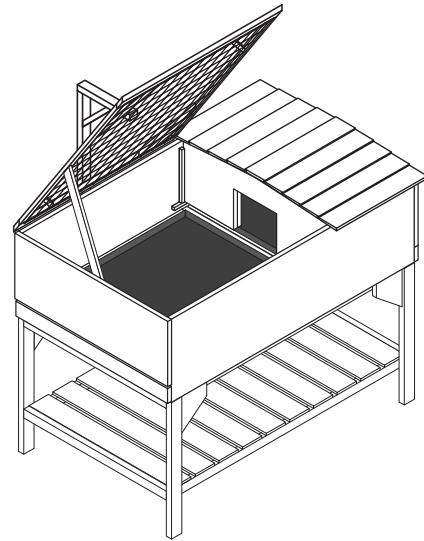

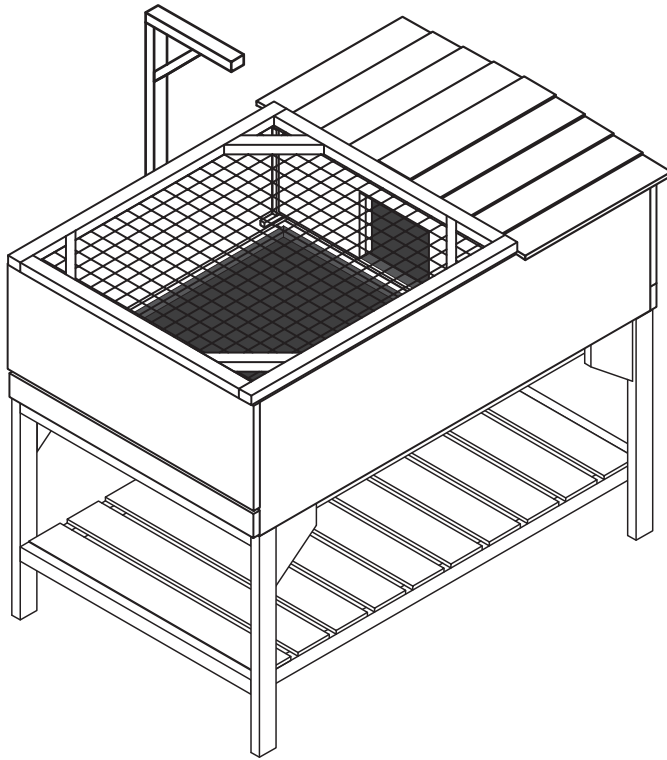

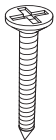





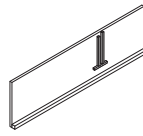
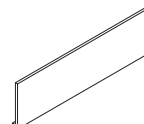

ASSEMBLY INSTRUCTION

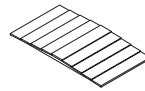
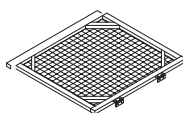
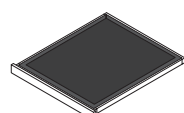
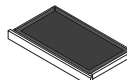

<p>A M4*35</p>  <p>22 pcs</p>	<p>B M4*30</p>  <p>12 pcs</p>	<p>C M3*12</p>  <p>4 pcs</p>	<p>D M3*20</p>  <p>1 pcs</p>	<p>1</p>  <p>1 pcs</p>	<p>2</p>  <p>1 pcs</p>	<p>3</p>  <p>1 pcs</p>	<p>4</p>  <p>1 pcs</p>
<p>5</p>  <p>1 pcs</p>	<p>6</p>  <p>1 pcs</p>	<p>7</p>  <p>1 pcs</p>	<p>8</p>  <p>1 pcs</p>	<p>9</p>  <p>1 pcs</p>	<p>10</p>  <p>1 pcs</p>		
<p>11</p>  <p>1 pcs</p>	<p>12</p>  <p>2 pcs</p>	<p>13</p>  <p>2 pcs</p>	<p>14</p>  <p>1 pcs</p>	<p>15</p>  <p>4 pcs</p>			

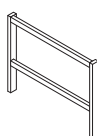
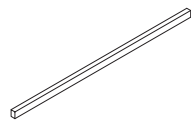
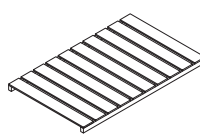
<p>1</p> <p>A:12pcs</p>	<p>2</p> <p>A:2pcs</p>
<p>3</p> <p>C:4pcs D:1pcs</p>	<p>4</p> <p>A:8pcs</p>
<p>5</p> <p>B:12pcs</p>	<p>6</p>