

HOROW®

Installation & User Manual

HOROW T37

Smart Toilet

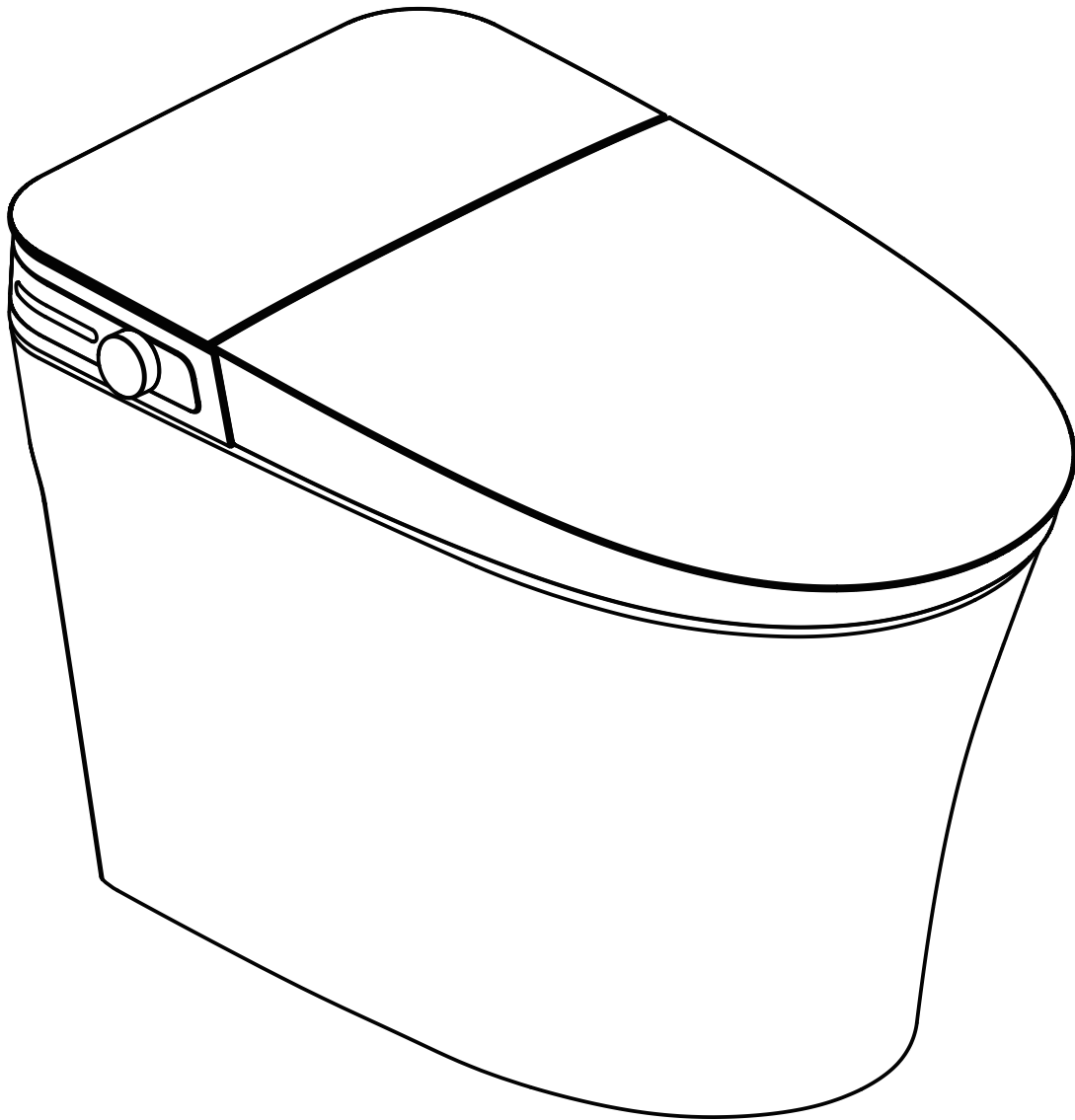

Contents

Important Safeguards	1
Important Information	1
Grounding Instructions	2
Explanation of Terms and Symbols	2
Overall Sketch	8
Function Table	9
Product Installation	10
Tools Needed for Installation	10
Parts Included	10
Prior to Installation	11
Installation of Smart Toilet	13
Installation of Battery Pack	16
Installation of Remote Control Holder	17
Product Test Run	18
Usage Instructions	19
Function Explanations	19
Foot Sensor Operations	22
Knob Operations	22
Remote Control Operations	23
Daily Maintenance	26
Maintenance of Ceramics, Seat and Lid	26
Maintenance of the Nozzle	27
Cleaning of the Filter	27
Maintenance During Winter Season	28
Troubleshooting	29
Specifications	30
Warranty	31

- Thank You for Choosing HOROW. Please read the instructions carefully before installation and keep it available for future maintenance or reference.
- We are not responsible for the accidents resulting from the user's negligence.
- HOROW reserves the right to make revisions to this manual without notice.



Need help? Contact HOROW Customer Service Team.

Phone: (+1)209-200-8033

Monday to Friday

Email: support@horow.com

Important Safeguards

Read All Instructions Before Using

Important Information

When using electrical products, especially when children are present, basic safety precautions should always be followed, including the following:



DANGER - To reduce the risk of electrocution:

1. Do not use while bathing.
2. Do not place or store product where it can fall or be pulled into a tub or sink.
3. Do not place in or drop into water or other liquid.
4. Do not reach for a product that has fallen into water. Unplug it immediately.
5. Do not wash the main unit or electrical plug with water or detergent.
6. During installation, disassembly, repair and maintenance of the product, the power plug must be switched off and the water supply be shut off.



WARNING - To reduce the risk of burns, electrocution, fire, or injury to persons:

1. Close supervision is necessary when this product is used by, on, or near children or invalids.
2. Use this product only for its intended use as described in this manual. Do not use attachments not recommended by HOROW.
3. Never operate this product if the cord or plug is damaged, if it is not working properly, or if it has been dropped, damaged, or immersed in water. If any of these conditions apply, contact our Customer Service Team directly.
4. Keep the cord away from heated surfaces.
5. Never block the air openings of the product or place it on a soft surface, such as a bed or couch, where the openings could be blocked. Ensure that the air openings remain free of lint, hair, and similar debris.
6. Never use while sleeping or drowsy.
7. Never drop or insert any object into any opening or hose.
8. Do not use outdoors or in environments where aerosol (spray) products are being used or oxygen is being administered.
9. Connect this product to a properly grounded outlet only.
See **Grounding Instructions**.
10. Caution - Risk of electric shock. Do not remove the toilet lid (or back) on your own. Refer servicing to qualified service personnel.

Grounding Instructions

This product should be grounded. In the event of an electrical short circuit, grounding reduces the risk of electric shock by providing an escape wire for the electric current. The product is equipped with a cord that has a grounding wire and a grounding plug. The plug must be inserted into an outlet that is properly installed and grounded.



DANGER - Improper use of the grounding plug can result in a risk of electric shock.

1. If repair or replacement of the cord or plug is necessary, do not connect the grounding wire to either fat blade terminal. The wire within insulation having an outer surface that is green with or without yellow stripes is the grounding wire.
2. Check with a qualified electrician or serviceman if the grounding instructions are not completely understood, or if in doubt as to whether the product is properly grounded.
3. This product is factory equipped with a specific electric cord and plug to permit connection to a proper electric circuit. Make sure that the product is connected to an outlet having the same configuration as the plug.
4. No adapter should be used with this product. Do not modify the plug provided - if it will not fit the outlet, have the proper outlet installed by a qualified electrician. If the product must be reconnected for use on a different type of electric circuit, the reconnection should be made by qualified service personnel.

Explanation of Terms and Symbols

To ensure proper and safe use of this product, please read this section carefully before use. After reading, store this manual in a safe place for any needed future reference.

The hazards and warnings listed herein are important to our user's safety. Significant consequences may result from failure to heed warnings. The company will not be held liable for any injuries or damages caused by improper use or failure to follow the safety instructions.

Warning

Indicate possible injury resulting from improper usage due to negligence of this sign.

Attention

Indicate human injury or property loss that may result from improper usage due to negligence of this sign.



Indicate a strict request to follow noted precautions when used with the above "Warning" and "Attention" signs.



Prohibit any individual from performing any action with this symbol.



Prohibit any individual from dismantling product.



Keep product away from any wet environments, including, but is not limited to, humid environments, close proximities to baths, showers or sinks.

 Do not touch!

 Operate only as instructed!

 Do not touch with a wet hand!

 Pull out the power plug!

 Keep away from any extreme heat or fire!

 Protective grounding.

Warning

This product needs to be properly grounded.

- ※ Risk of electric shock.
- ※ If unsure, contact an electrician.



Do not place a lit cigarette along with other burning objects into the unit.

- ※ Risk of fire.



Do not touch, insert or pull out the power plug with a wet hand.

- ※ Risk of electric shock.



Do not use during thunderstorms (pull out the power plug during storms).

- ※ Failure in doing so may lead to injury or fault in the product.



Do not use a power socket in poor condition or a damaged power plug.

- ※ Risk of fire and/or electric shock.

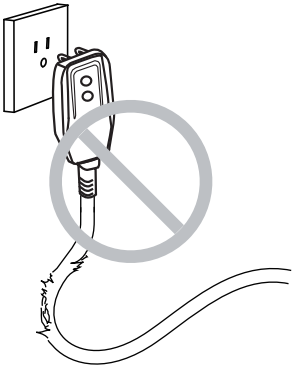

When the seat ring or the lid is damaged, to avoid any harm, be sure to pull off the power plug, close the water source and contact your local electrical installation company for replacement.

- ※ Risk of fire and/or electric shock.

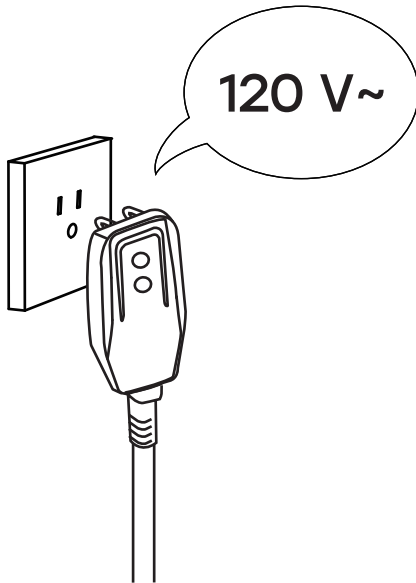

The power socket in use should be within the specified range.

- ※ Risk of fire and/or electric shock.



Regularly pull out the power plug and wipe off any dust on the power plug using a clean dry cloth.

- ※ Risk of fire.



Any person with a disability, the elderly, and children should be using this product with the supervision of another individual.

- ※ Be advised that sitting on the heated seat for an extended amount of time may result in burns.



Do not pull, damage, bend, twist, stretch, roll, bundle, clamp or squeeze the cord. Do not place anything on the cord.

- ※ Risk of fire and/or electric shock.



This product is not a toy. Advise children not to play with product.

- ※ Risk of injury.



If the power cord is damaged, to prevent any injuries or accidents, it should be replaced by a professional.

- ※ Risk of fire and/or electric shock.



Do not dismantle, repair or alter this product on your own. Call in a professional for further advice.

- ※ Risk of fire, electric shock, and/or other accident that may lead to injury.



For cleaning or maintenance of plastic parts, do not use any harsh cleaning agents. (These include, but are not limited to products such as concentrated sulfuric acid, concentrated nitric acid, glacial acetic acid, carbon tetrachloride, chloroform, benzene, phenol, methylphenol, dimethylformamide, methyl ether, soybean oil, acetate, 40% nitric acid, thick salt acid, 95% alcohol, gasoline, kerosene, etc.)



※ Risk of damaging parts that can lead to accidents and injuries.

Do not use polluted water or water meant for industrial use.



- ※ Risk of cystitis and dermatitis.
- ※ Untreated water may also cause internal corrosion of the product and may cause electrical shock or a fire.

Do not apply any force to the unit's seat and lid. Do not stand on the lid or open or close the lid and the seat forcefully.

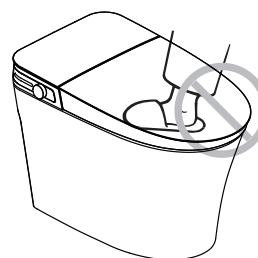

※ Risk of product damage and/or user injury.

Do not add water or detergent into the unit or onto the wireless remote control. Do not soak the product with water or cleaner.



※ Risk of fire and/or electric shock.

Do not install the product in a humid environment or a soaked room. Do not spray or soak this product with any form of liquid to prevent any damage to the product.



※ Risk of fire, electric shock, and/or other accident that may lead to user injury.

Do not place your hand or any other object into the dryer trap, and do not cover the dryer and dryer trap during product use.

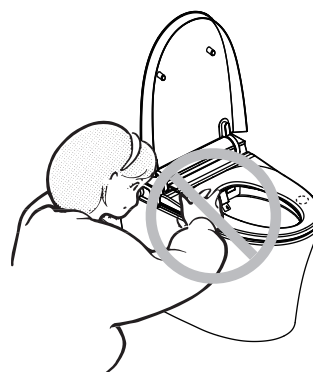

※ Risk of fire, electric shock and/or other accident that may lead to user injury.

Do not spray urine at the dryer.



※ Risk of electric shock.

 **Battery Warning**

Read the following for proper battery usage.

- ① Properly install the battery according to its correct polarity.
- ② Remove the battery during long periods without use.
- ③ Replace the battery in time.
 - ✘ Failure to do so may result in interrupted control signals.
- ④ Cover the battery with tape before disposal. This will prevent battery fluid leaks that may cause fire and/or other damages.
- ⑤ Place the battery out of children and infant reach.
 - ✘ If battery is swallowed, contact a doctor immediately.
- ⑥ If battery fluid leaks onto user, quickly rinse off using clean water.
- ⑦ If battery fluid gets into eyes, do not rub your eyes. Quickly rinse it with clean water and consult a doctor immediately.
 - ✘ Failure to do so may result in vision impairment or blindness.

**When the battery is in use, do not do the following operations:**

- ① Do not hold or store with metal objects (such as a necklace or a watch).
- ② Do not mix new and old batteries.
- ③ Do not pull apart battery or throw it into water and/or fire. Battery fluids may cause a fire.



 **Attention**

Do not use the heated seat or warm dryer temperature for an extended amount of time.

- ※ Extended use may result in burns.



Avoid direct sunlight or heat.

- ※ Risk of product discoloration.



While using this product, make sure that the skin is in contact with the seat sensor area. Otherwise, the product may not operate correctly.

- ※ Children and smaller individuals may have trouble staying in contact with sensor area.



Do not spray urine in the direction of the bidet nozzle.

- ※ Doing so may result in blockage to the bidet nozzles and cleaning area.



Do not supply electricity with an external switch, i.e., connecting the universal part to a timer switch.

- ※ Risk of problems caused by improperly resetting the thermal breaker.



Pull out the power plug when the product is in disuse for an extended amount of time. Make sure to shut off the water and remove the water inside the product.

- ※ Risk of fire, leakage and product damage.



When storing or transporting in cold climate, make sure to remove all water from the unit. Product may crack and other damages may occur due to freezing water.

- ※ Risk of fire, leakage and product damage.



In case of sudden power failure, pull out the power plug and turn off the angle valve to prevent water leakage.

- ※ Risk of water leakage and/or property loss.



Overall Sketch

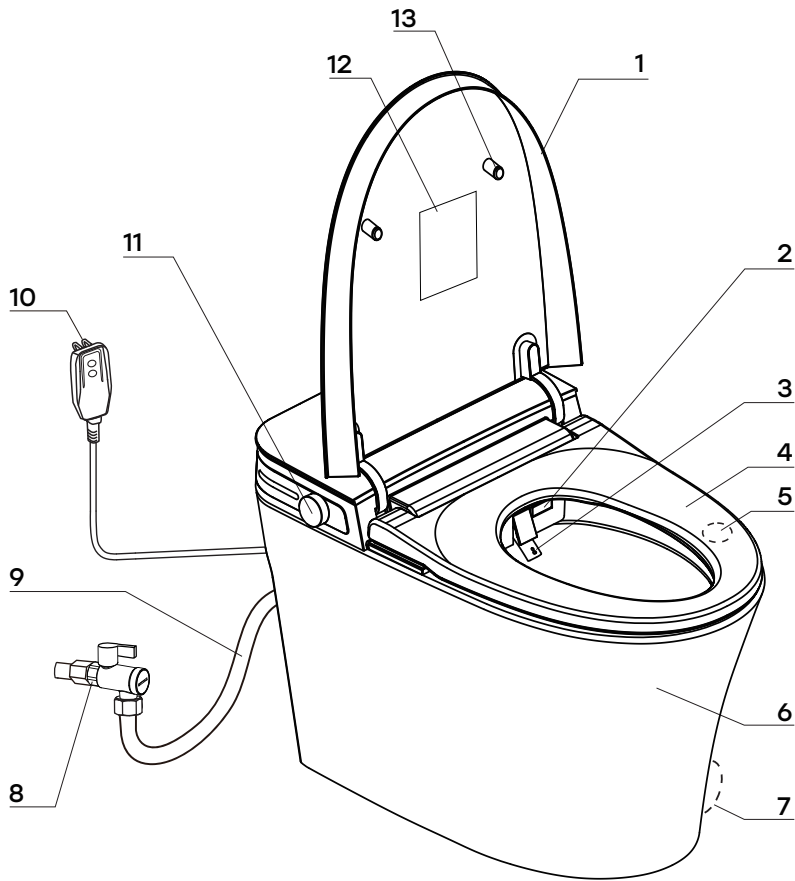

1	Lid
2	Warm Dryer
3	Nozzle
4	Heated Seat
5	Seat Sensor
6	Ceramic Toilet Bowl
7	Foot Sensor
8	Angle Valve
9	Water Hose
10	Power Plug
11	Knob
12	Caution Label
13	Cushion Pad

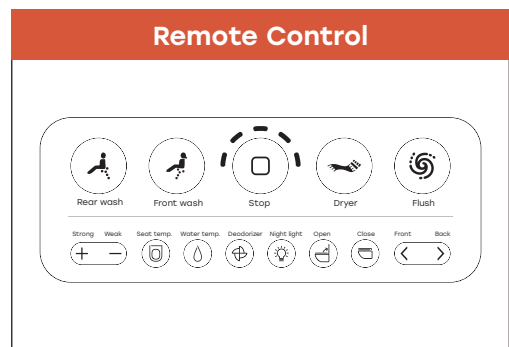
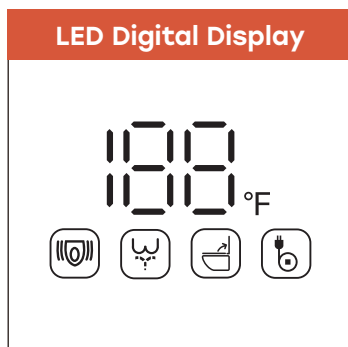
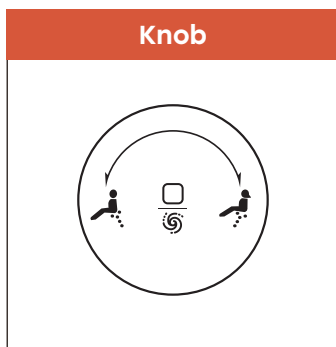

※ Two AAA batteries for the remote control and the 9 V battery for blackout flush are included in the product package.

Function Table

Category	Model	
	Functions	T37
Hygiene	Front Wash	●
	Rear Wash	●
	Movement Wash	●
	Self-cleaning Nozzle	●
	Nozzle Clean	●
	UV Sterilization	●
	Anti-bacterial Seat	●
	Easy-clean Glaze	●
	Pre-wet	●
Comfort	Instant Heating	●
	Adjustable Water Temperature	●
	Adjustable Water Pressure	●
	Bubble Wash (Water & Air Mixed)	●
	Adjustable Nozzle Position	●
	Heated Seat	●
	Adjustable Seat Temperature	●
	Warm Dryer	●
	Adjustable Dryer Temperature	●
Convenience	Auto Deodorization	●
	Auto Open Lid	●
	Auto Wash	●
	Auto Flush	●
	Drying Flush	●
	Blackout Flush	●
	Remote Flush	●
	LED Digital Display	●
	Remote Open Lid/Seat	●
	Kick Open Lid/Seat	●
	Night Light	●
	Energy-saving Mode	●
Safety	Soft Close	●
	Factory Data Reset	●
	SUS Filter	●
	Air Isolation & Backflow Prevention	●
	Multiple Protections	●
	Fire and Heat Resistant	●

Product Installation





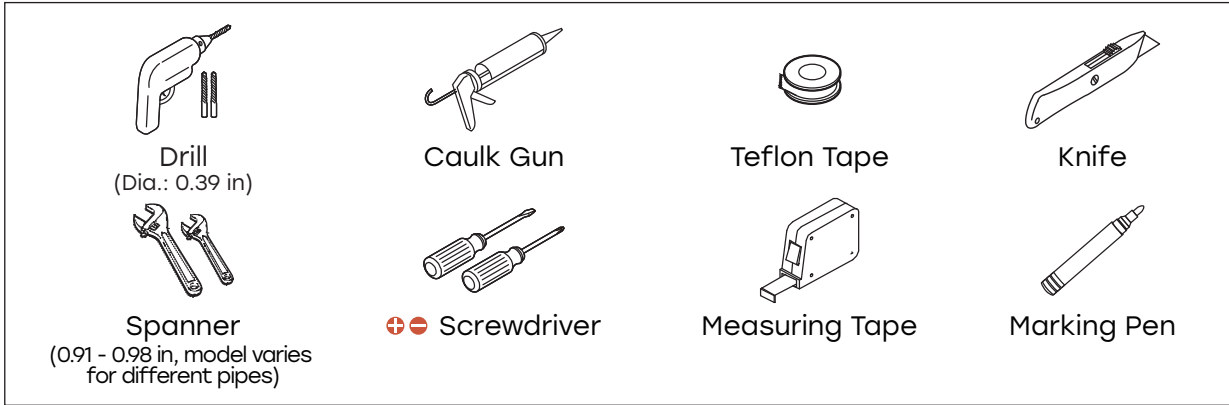



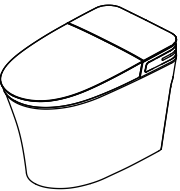
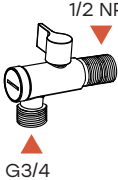
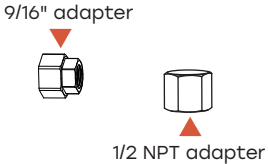

Tools Needed for Installation

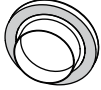
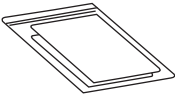
Please have these tools prepared prior to installation.



Parts Included

Please confirm that all items below are inside the box.

<p>Smart Toilet (1 pc)</p> 	<p>Angle Valve (1 pc)</p> 	<p>Adapter (2 pcs)</p> 
<p>Remote Control Set (1 pc)</p> 	<p>Battery</p>  <p>(AAA battery 2 pcs) (9 V alkaline battery (6LR61) 1 pc)</p>	<p>Wax Ring (1 pc)</p> 
<p>Installation & User Manual</p> 	<p>Floor Flange (1 pc)</p> 	<p>Water Flow Detection Bag (1 pc)</p> 
<p>Mounting Accessory Kit:</p> <ul style="list-style-type: none"> <li style="width: 33%;"> Expansion Bolt (4 pcs) <li style="width: 33%;"> Washer (6 pcs) <li style="width: 33%;"> Nut (2 pcs) <li style="width: 33%;"> Screw (4 pcs) <li style="width: 33%;"> Bolt (2 pcs) 		

Prior to Installation

Please confirm that all the aforementioned items in the package are present. In case of any missing parts, please feel free to contact our Customer Service Team. Illustrations above are for reference only. The ceramic product may have slight deformation during the firing process. Please consult the actual product for accurate details.

Verify the product dimensions and secure enough installation space. The rough-in size refers to the distance between the center of the toilet flange to the finished back wall.

※ All dimensions are manually measured with a certain degree of error. For the specific size, please refer to the actual product received.

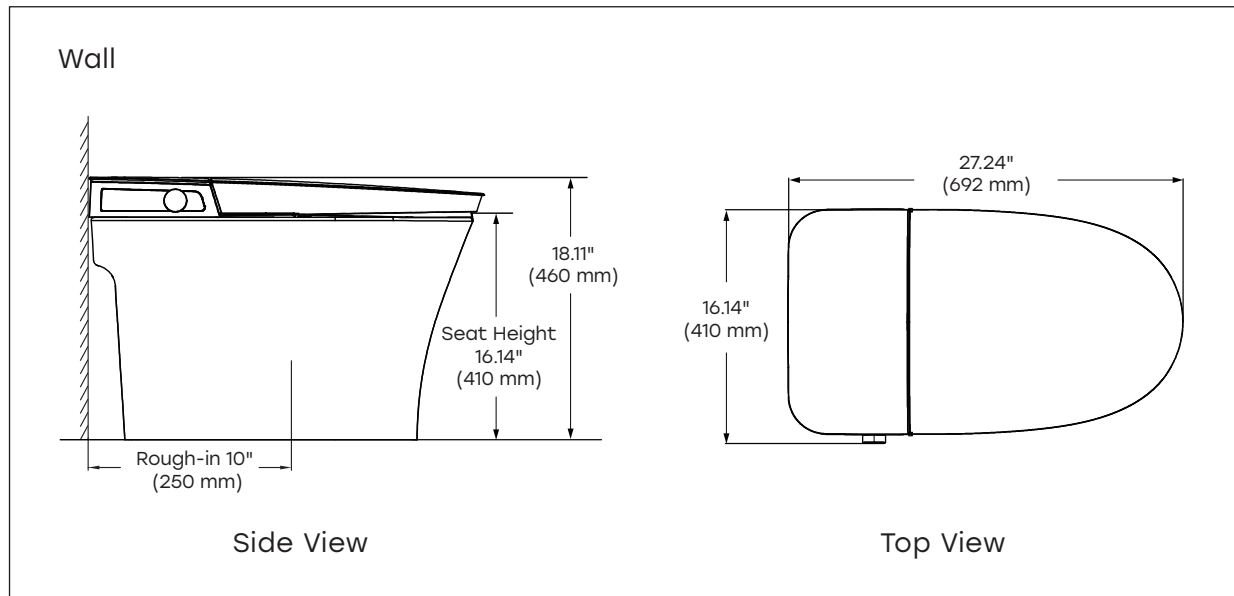

To ensure proper installation, the distance between the water supply valve and the centerline of the toilet should be greater than half the width of the toilet bottom. The water supply valve should be about 7.5 inches away from the toilet centerline. For larger valves, a greater distance may be necessary to ensure proper clearance. For easy installation and maintenance, a range of 9 to 11 inches is recommended.

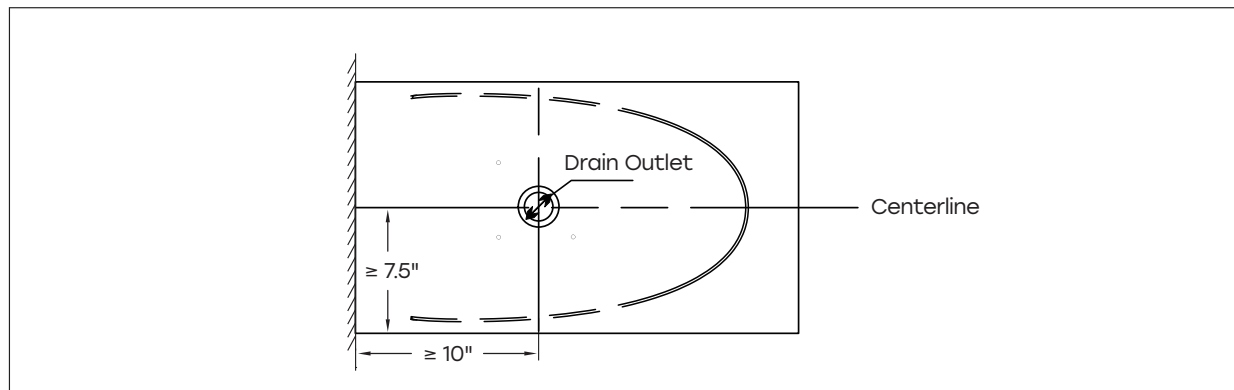

The minimum water pressure required is 20.3 psi, and the maximum water pressure is 108 psi. A water flow detection bag is provided for the user to test whether the water pressure is qualified.

Install a suitable hose onto your water outlet and direct it to the water flow detection bag provided.

- ※ If you cannot find a compatible hose, you can cover the water outlet with a cloth and place a bucket (3 gallons or more) under the valve.

Turn on the angle valve and ensure that at least 1.19 gallons of water flow out within 15 seconds.

- ※ If this condition is not met, the flushing efficiency may be compromised. In this case, you may need to remove the flow regulator or use an additional booster pump to increase the water pressure.

Turn off the angle valve and remove the hose installed.

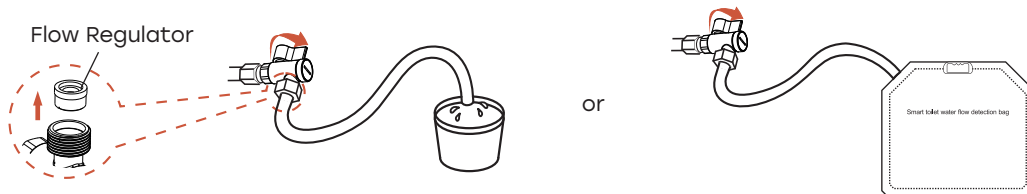

Electrical requirements for this product: 10 Amps at AC 120 V, 60 Hz.

Installation of Smart Toilet

Install your toilet using the following steps:

Please remove the old toilet first if any and ensure the mounting surface is clean and level before the new toilet is installed.

1 Open the box right side up

Remove the accessories first, then lift the toilet with two people, remove the packaging, and gently place the toilet on the floor, as shown in the diagrams below.

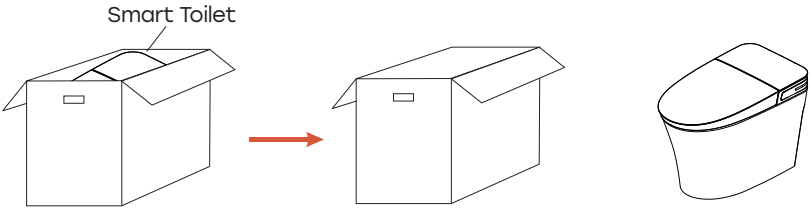

2 Install the angle valve

Turn off the water supply and then remove the existing supply stop valve. Turn on the water supply and flush for 1 minute to clear any debris that may damage the toilet structure. Turn off the water supply. Wrap Teflon tape around the threaded end of the water supply pipe to ensure a watertight seal. Screw the needed adapter onto the water supply pipe.

Connect the angle valve to the water supply pipe, using a gasket to prevent water leakage.

※ For the joint assembly, tighten the threaded joint 1 ~ 2 turns beyond finger tight, ensuring not to overtighten.

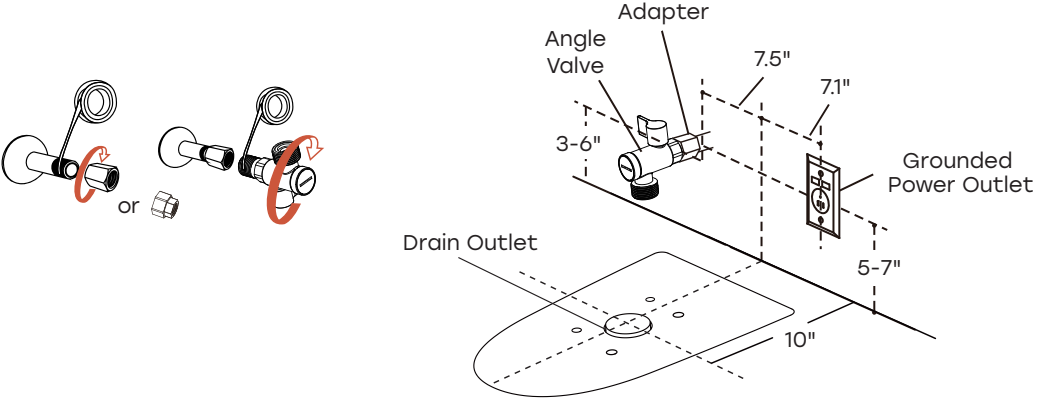

3 Install and fix the flange

Place the flange on the ground and align it with the centerline of drain outlet. Mark four mounting holes with the marking pen.

Drill four holes at the marked locations. Insert four expansion bolts into the holes. Position the flange on the drain outlet, aligning the four flange holes with the drilled holes on the ground. Insert the washers and screws into the flange holes and tighten them using a screwdriver.

Install the bolts on opposite sides of the flange on the ground.

※ If an applicable flange is already in place, there is no need to install the new one.

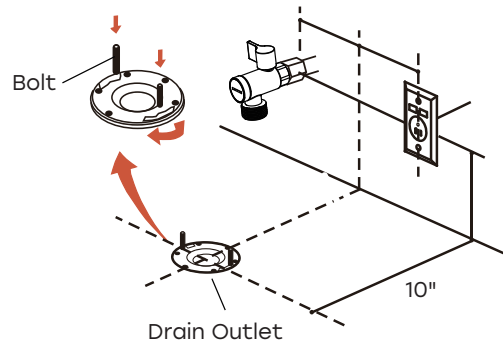
**4 Install the ceramic toilet**

Install the wax ring onto the drain hole at the bottom of the ceramic toilet and press it firmly into place.

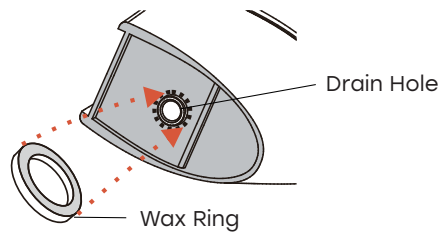

Lift the ceramic toilet with two people and gently lower it onto the flange, aligning the bolts with the mounting holes.

Press down firmly on the ceramic toilet to ensure the wax ring forms a complete seal.

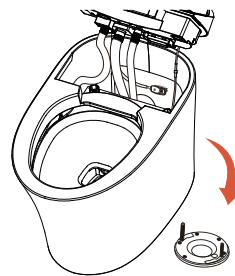

Tips:

- ※ The toilet is heavy, and it needs two people to carry it.
- ※ Please clean the drain outlet.
- ※ Please make sure ceramic toilet outlet sits perfectly on the drain outlet.

Lift the toilet seat-lid assembly from the back right of the toilet, as shown in the diagram below.

※ Avoid pulling the lid too hard when lifting the toilet seat-lid assembly.

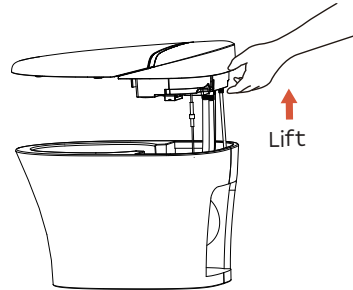

Use a spanner to securely tighten the bolts with washers and nuts from the top.

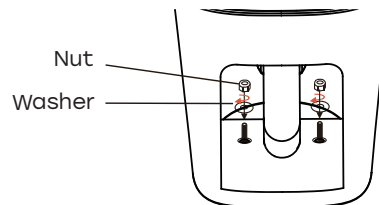

Reinstall the toilet seat-lid assembly.

※ Avoid applying excessive force when reattaching the seat-lid assembly.

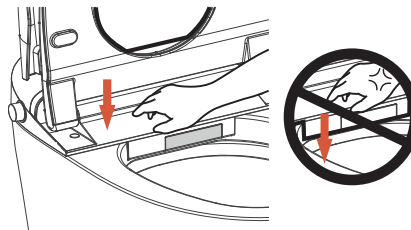
**5****Install the water hose**

Connect the water hose to the installed angle valve and tighten it.

Use Teflon tape on all threaded connections to ensure a watertight seal.

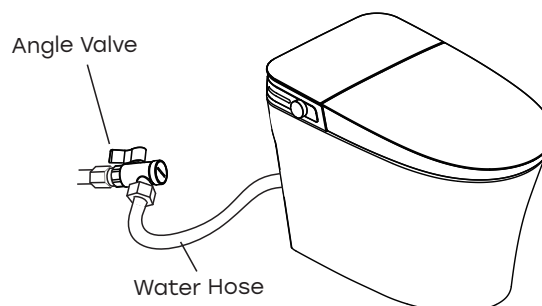

Installation of Battery Pack

The battery pack is primarily used for blackout flush in case of a power outage. It provides emergency power to the toilet. The battery box is installed inside the toilet, and it uses the provided 9 V alkaline battery. For any questions, please contact our Customer Service Team.

+ Install the battery

Locate the battery pack as shown and carefully remove the battery box cover. Insert the battery, and then slide the cover back onto the battery box.

Press the side knob to ensure the flush is functioning properly.

※ The battery should be placed out of the reach of children.

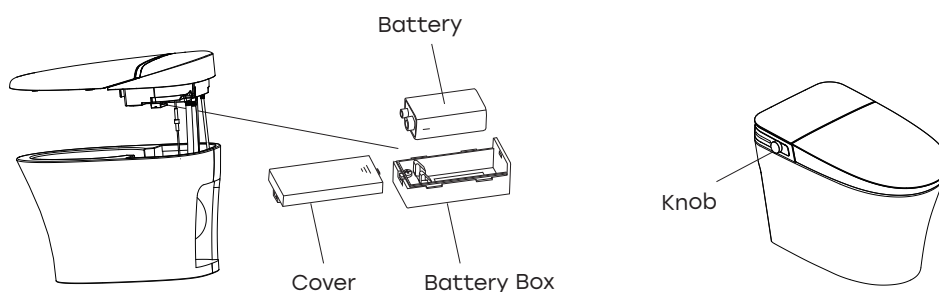

+ Replace the battery

Locate the battery pack and carefully remove the battery box cover.

Remove the used battery, insert the new one and then slide the cover back onto the battery box.

Press the side knob to ensure the flush is functioning properly.

※ A single battery pack can support approximately 100 flushes during a power outage. Please note that the battery naturally degrades over time, even when not in use.

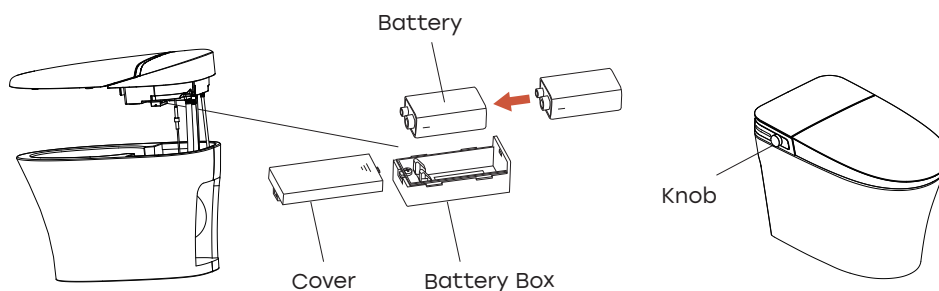

Installation of Remote Control Holder



Peel off the backing paper from the double-sided tape on the back of the remote control holder.

Attach the holder to the wall, pressing the tape firmly and evenly.

- ※ Clean the installation surface before mounting. Wait for 15 minutes after installation.
- ※ The remote control holder should be installed away from the bidet's spray trajectory.
- ※ The remote control holder should be installed within reach when seated on the toilet.
- ※ Make sure there is nothing to block the transmission between the toilet and its remote control.

①

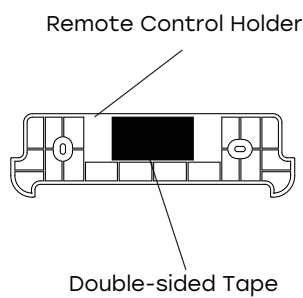

②

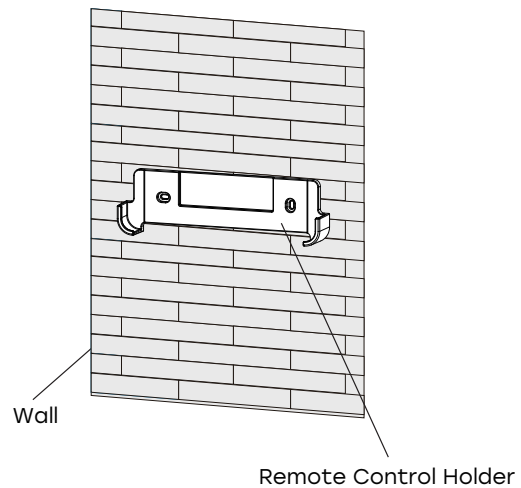

Product Test Run

1

Water Connection

Turn the water supply angle valve to the maximum opening, as shown in the diagram.

Make sure no leakage is found at various connection parts.

※ In case of any water leakage, unfasten the nuts and install them again.

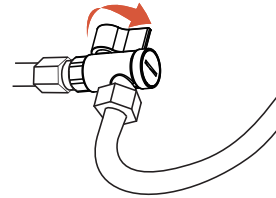
**2**

Power Connection

Ensure the electrical requirements are met: 10 A at AC 120 V, 60 Hz.

Plug the power plug into AC 120 V socket.

Press the knob on the toilet to start a flush and confirm the toilet is powered on.

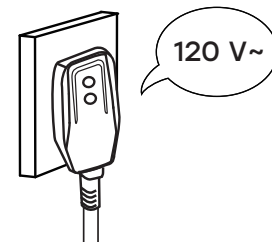
**3**

Smart Toilet Running

Are all functions working properly?

Test all function buttons on the remote control and the knob on the toilet.

Verify the normal operation of each function.

For example, approach the toilet sensor area to test the automatic open lid. Kick the foot sensor area to raise the toilet seat automatically.

Operate the remote control and confirm the functionality of Front Wash, Rear Wash (including water pressure and nozzle position adjustment), Warm Dryer, Air Temperature and Water Temperature Adjustment, Nozzle Clean and Night Light.

All functions listed above should be tested. Please ensure all specified functions run correctly.

After the toilet is installed and the test run is completed, it is recommended that you apply the silicone sealant around the base of the toilet. Please avoid applying sealant where the access covers meet the floor.

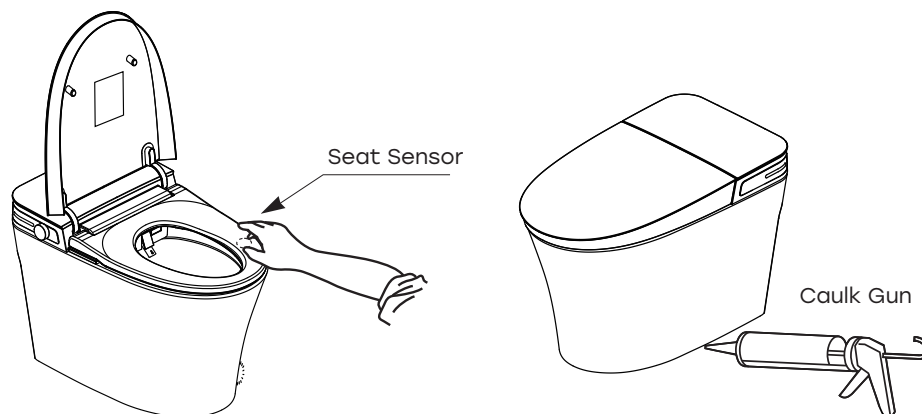

Usage Instructions

Function Explanations



Auto Flush

The toilet will automatically flush after the seat sensor no longer detects a user if no flush is performed during seat occupancy.

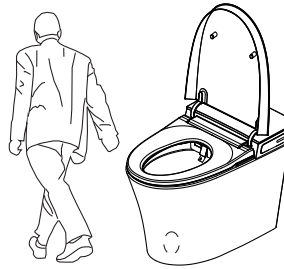

Drying Flush

Press **Dryer** on the remote control to activate the dryer to blow warm air. If no flush is executed after front or rear wash, a flush will be performed automatically to eliminate unpleasant odors before the dryer is activated. Front/rear wash is not available during the flush process.

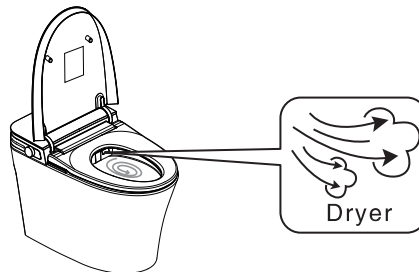

Microwave Induction

Microwave induction, also known as auto open/close lid, uses the microwave induction technology to detect users within a specified range. The lid will automatically open when a user approaches within this range. The lid will automatically close when the user leaves for a while and the sensor no longer detects any microwave signal.

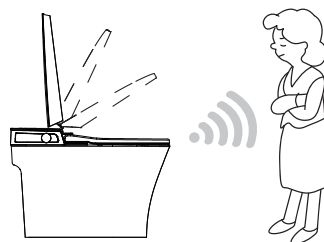

**LED Digital Display**

When different functions are activated, the corresponding function animation is displayed or the indicator light is on.

The  icon indicates the seat temperature. When adjusting the temperature, the icon lights up, and the current temperature is displayed.

The  icon indicates the cleaning water temperature. When adjusting the temperature, the icon lights up, and the current temperature is displayed.

The  icon indicates that the microwave induction function is activated.

The  icon indicates that the energy-saving mode is activated.

**Blackout Flush**

Blackout flush refers to the manual emergency flush during a power outage.

Press the knob to activate blackout flush.

If the above operation does not work properly, you need to replace the battery or contact our Customer Service Team.



**Auto Deodorization**

The deodorization function will be activated automatically when the seat is occupied and will be turned off 1.5 minutes after the seat is unoccupied.

A deodorizer cartridge and a fan are installed at the back of the toilet to help eliminate unpleasant odors and improve ventilation.

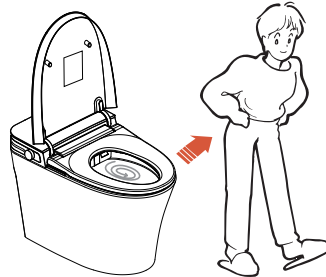
**UV Sterilization**

An ultraviolet lamp is installed and concealed inside the smart toilet.

Ultraviolet rays sterilize the nozzle surface. UV sterilization will start automatically 15 seconds after the seat is unoccupied and it will work for 3 minutes. It will restart every 4 hours.

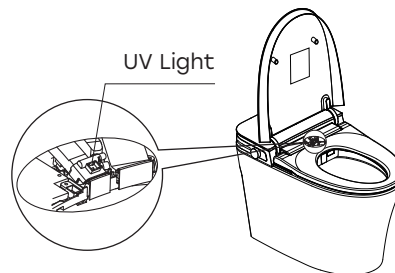
**User-friendly Design****① Pre-wet**

When the toilet seat is occupied, the product will flush automatically once towards the seat to moisten the toilet bowl.

② Multiple Protections

Multiple built-in safety features are designed to protect both the user and the product.

③ Memory Mode

The toilet automatically remembers and retains the last-used settings, including water temperature, seat temperature, warm air temperature, nozzle position and other user preferences. Such settings will revert to factory defaults in the event of a power failure.

④ Antibacterial Seat

The seat is made of antibacterial material to ensure enhanced hygiene.

⑤ Energy-saving Mode

When enabled, the toilet conserves energy by maintaining the heated seat temperature at 77 °F when not in use. Once seated, the seat returns to the preset temperature.

Foot Sensor Operations

+

The toilet is equipped with a foot sensor, located as shown below, allowing you to open and close the lid and the seat, as well as activate the flush when the lid is closed.

Tap the sensor area with your foot to raise your toilet lid/seat.

Tap the foot sensor area once: Lid opens.

Tap the foot sensor area twice: Seat raises.

Tap the foot sensor area three times: Seat and lid will close and the toilet will flush immediately.

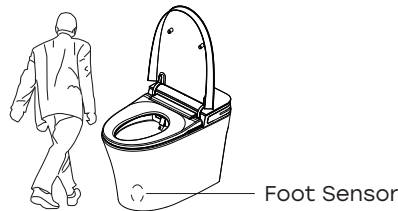

※ The foot sensor triggers only a small flush. If the sensor area is kicked when the seat is occupied, it will not respond.

Knob Operations

+

Power/Stop

When the toilet is powered on and no one is seated, press and hold the knob for 3 seconds to enter the standby mode. The indicator light will be off.

When the toilet is in standby mode, rotate the knob clockwise or counterclockwise, or press the knob to enter the idle mode. The indicator light will turn pink.

When the toilet is in front/rear wash or drying mode, press the knob to stop the function. The indicator light will turn pink.

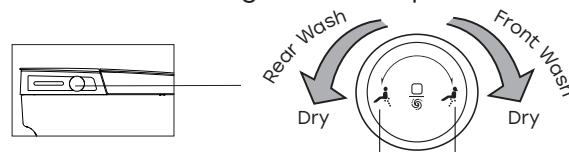

Rear Wash

Rotate counterclockwise

When the seat is occupied and the toilet is not in wash or drying mode, rotate the knob counterclockwise to start the smart rear wash cycle.

Movement wash is provided by default. The entire process includes rear wash, auto flush and warm air drying, taking approximately 6 minutes.

During the smart rear wash, rotate the knob counterclockwise to stop the wash and activate the warm dryer. The indicator light will turn blue for rear wash, and red for warm air drying.

※ When the seat is unoccupied and the toilet is not in use, press the knob once to activate a full flush; press the knob twice consecutively to activate a small flush.

Front Wash

Rotate clockwise

When the seat is occupied and the toilet is not in wash or drying mode, rotate the knob clockwise to start the smart front wash cycle.

Movement wash is provided by default. The entire process includes front wash, auto flush and warm air drying, taking approximately 6 minutes.

During the smart front wash, rotate the knob clockwise to stop the wash and activate the warm dryer. The indicator light will turn pink for front wash, and red for warm air drying.

Remote Control Operations

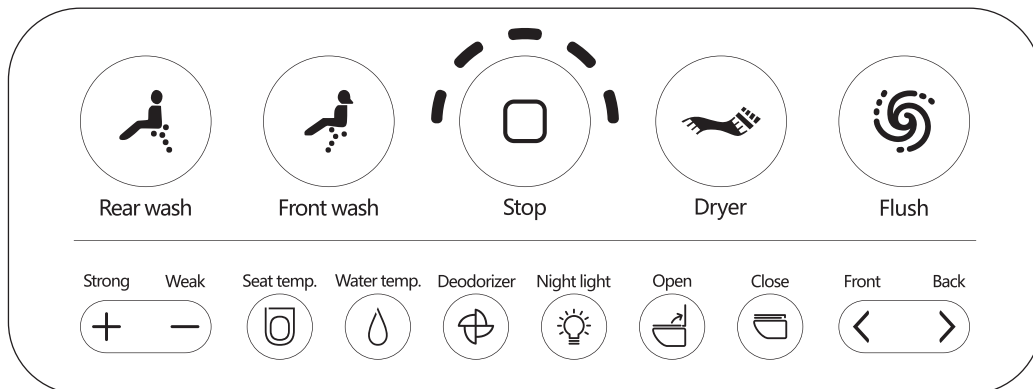

Press **Rear wash** to start rear cleaning. Press again to activate movement wash, and press a third time to return to rear wash. It will stop after approximately 2 minutes.

Press and hold **Rear wash** for 3 seconds to start strong wash. At this time, the cleaning intensity is level 4. It will stop after approximately 2 minutes. Or press **Rear wash** again to stop it.

Press **Front wash** to start feminine cleaning. Press again to activate movement wash, and press a third time to return to front wash. It will stop after approximately 2 minutes.

Press and hold **Front wash** for 3 seconds to extend the nozzle out while unseated, allowing the user to clean it manually.

※ The nozzle will automatically clean itself before and after rear wash and front wash.

Press **Stop** to stop any activated wash functions (front wash or rear wash) or the dryer.

Press and hold **Stop** for 3 seconds to turn off the toilet.

Press **Dryer** to dry off the water after using the wash function. It will stop after approximately 4 minutes.

Press **Flush** to flush the toilet after use.

Press and hold **Flush** for 3 seconds to enable/disable the auto flush function. When enabled, the No. 4 level light (counting from left to right) on the remote control will illuminate.

Press **Strong/Weak** to adjust the cleaning intensity during front or rear wash. Press **Strong** to increase the intensity and **Weak** to decrease it.

Press **Strong/Weak** to adjust the warm air temperature during drying. Press **Strong** to increase the temperature and **Weak** to decrease it.

Press **Seat temp.** to adjust the heated seat temperature while seated. Four seat temperature levels are available: normal, low (91 °F), medium (97 °F) and high (102 °F). Each press will adjust the temperature in the following sequence: medium - high - medium - low - normal - low - medium, cycling continuously.

※ To prevent low-temperature burns, the seat temperature will automatically be reduced to below 95 °F after 10 minutes of continuous seating.

Press **Water temp.** to adjust the water temperature for any wash function. Four water temperature levels are available: normal, low (91 °F), medium (97 °F) and high (102 °F). Each press will adjust the temperature in the following sequence: medium - high - medium - low - normal - low - medium, cycling continuously.

Press **Deodorizer** to enable/disable auto deodorization. When enabled, the No. 3 level light on the remote control will illuminate.

※ Auto deodorization is enabled by default.

Press **Night light** to turn the night light on or off.

Press **Open** to control auto open of the lid and seat while unseated.

Press **Close** to control auto close of the lid and seat while unseated.

Press and hold **Open** for 3 seconds to enable/disable the microwave induction function (auto open/close lid). When enabled, the No. 2 level light on the remote control will illuminate.

Press **Front/Back** to adjust the nozzle position.

Remote Control Settings for Special Modes

• Energy-saving Mode

When enabled, the toilet conserves energy by maintaining the heated seat temperature at 77 °F when not in use. Once seated, the seat returns to the preset temperature.



Press and hold **Deodorizer** for 3 seconds to enable/disable the energy-saving mode. When enabled, the No. 5 level light on the remote control will illuminate.

• Settings Mode

If entering this mode, the remote control can be used to enable or disable the automatic functions of the toilet as described below.

Press and hold **Water temp.** and **Open** simultaneously until the No. 3 level light  flashes to enter the Settings Mode.

Note: The pre-wet function is enabled by default from the factory, whereas others remain disabled. To make adjustments, please enter into the Settings Mode to enable or disable these functions.

A single illuminated level light  indicates that the function has been enabled, while 2 illuminated level lights  indicate that the function has been disabled.

Press **Night light** to enable/disable the buzzer.

※ When disabled, no audio prompts will be heard during knob and remote control operations.

Press **Deodorizer** to enable/disable the pre-wet function.



Press **Flush** to enable/disable the super powerful flush function.

After the settings needed are completed, press **Stop** to save them and exit the Settings Mode. At this point, the No. 1, No. 2 and No. 3 level lights will illuminate.

If no operation is done within 15 seconds after entering Settings Mode, the mode will automatically exit.

Code Pairing of Remote Control

The remote control is pre-paired with the smart toilet at the factory for immediate use. However, if the remote control isn't functioning properly, or if you own multiple toilets of the same brand and experience interference when operating them, you can manually pair the remote control with the toilet.

+ Unplug the toilet. Press and hold **Deodorizer**  and **Night light**  for a few seconds until all the level lights constantly flicker.

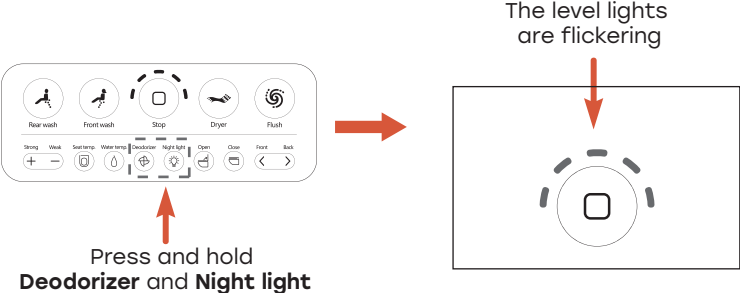

The level lights are flickering

Press and hold **Deodorizer** and **Night light**

Place the remote control near the product and plug the attaching plug in 5 seconds.

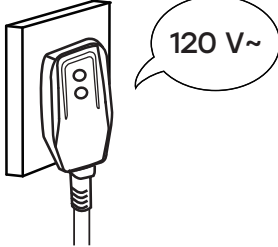

120 V~

The level lights stop flickering, and then they are lighted on. Codes are paired successfully when all lights are on.

All the level lights are normally on



Daily Maintenance

Regular maintenance is required to ensure normal use.

+**Note:**

1. Cut off the power and water supply before maintenance.
2. Direct water wash to the entire product is prohibited.

+**Warning:**

Do not spray water or detergents on the toilet, remote control or the power cord. Doing so may cause electric shock or fire.

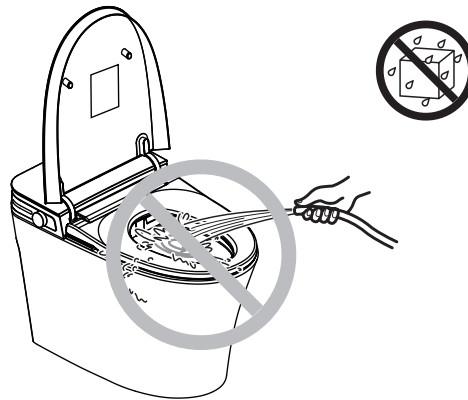

Maintenance of Ceramics, Seat and Lid

+

1. Wipe dust or stains with a soft wet cloth.
2. A wet soft brush, cloth, or sponge may be used to clean the ceramic area.

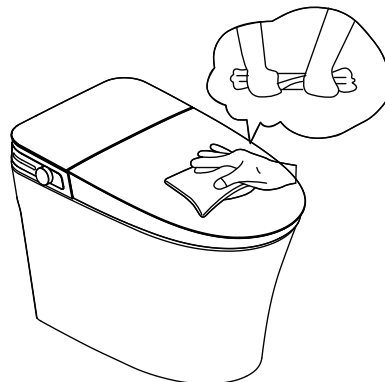

※ Do not use abrasive cleaners, such as alcohol, bleach, painter thinner, cresol, benzene, gasoline, etc.

Maintenance of the Nozzle

+

Press and hold **Front wash** on the remote control for 3 seconds without occupying the seat when the toilet is powered on. The nozzle will extend out. Proceed to clean it with a soft toothbrush.

Press **Stop** on the remote control to return the nozzle to the original position.

※ Do not use steel brush to clean it.

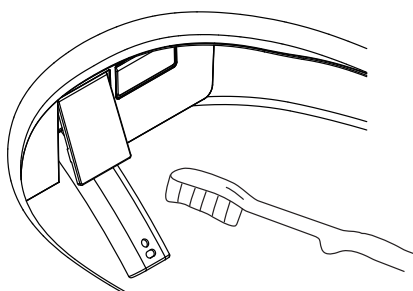

Cleaning of the Filter

+

If the water pressure is too low or insufficient, please clean the filter.

Turn off the angle valve to stop the water supply.

Use a flathead screwdriver to unscrew the filter cover, then remove the cover as shown below.

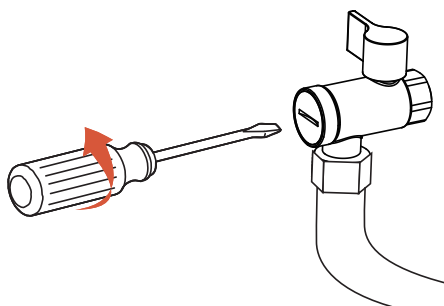

Take out the filter and clean it thoroughly. You can rinse off dirt or gently clean it with a toothbrush.

※ Do not use any cleaning agents. Clean the filter with water only.

※ Be careful not to crush or distort the filter while cleaning.

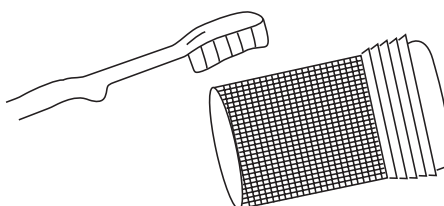

Reinstall the filter in the reverse order of removal.

After installation, open the angle valve and check for any water leakage.

Maintenance During Winter Season

During the winter season, the water inside may freeze after long periods of storage and non-use. Please take measures to prevent.

**Note:**

1. Before connecting the product to the water supply and electrical outlet, allow it to defrost for 30 minutes in a warm indoor environment.
2. In cases of extreme cold/freezing/nozzle stuck in place, wrap the water input line with a warm towel. Never pour hot water or use a hot dryer directly on the toilet.

Troubleshooting

This Troubleshooting Guide is for general aid only. If the user encounters any problems, please first consult the troubleshooting guide below. If the problem persists, please contact our Customer Service Team.



Scan the QR code for video resources and find the troubleshooting videos you need.

Power Button		
Phenomenon	Fault Diagnoses	Solutions
Not working	Check whether the attaching plug is loose or not	Please check the circuit
	Check whether the power is switching on or off (the power light is not on)	Press and hold the knob, the power light is on
	Check whether there is any electric leakage or not	Unplug the attaching plug from the socket, plug it again later, if it is still not working, please unplug the attaching plug and contact our Customer Service Team
Wash Functions		
Phenomenon	Fault Diagnoses	Solutions
No water comes out while cleaning	Check whether the pressure of water supply is low or not	Increase the water pressure
	Check whether the water filter is blocked or not	Clean the filter according to the Installation & User Manual
The water temperature is not warm enough	Check whether the water temperature switches to low level or not	Regulate the water temperature according to the Installation & User Manual
Heated Seat		
Phenomenon	Fault Diagnoses	Solutions
The seat temperature is too low or is not hot	Check whether the temperature of toilet seat is on the OFF position or not	Regulate the temperature of toilet seat according to the Installation & User Manual
Seat and lid are loose	Check whether the fixed bolts are loose or not	Tighten the bolts
Remote Control		
Phenomenon	Fault Diagnoses	Solutions
Remote control failed	Low battery	Please replace new battery
No response when pressing the key	Key fault	Reboot or contact our Customer Service Team
Ceramic Toilet		
Phenomenon	Fault Diagnoses	Solutions
Water leakage	Check whether the shutoff valve, water supply hose and water separator are well connected or not	Reconnect them carefully

Specifications

Product Model		HOROW T37
Product Dimensions		27.24 in (L) * 16.14 in (W) * 18.11 in (H)
Product Weight (lb.)		77.16 lb
Rough In Size		10 in
Seat Height		16.14 in
Bowl/Seat Shape		Elongated
Flush Type		Tornado flush
Gallons Per Flush (US gallon)		Dual Flush: 1.0/1.28
Installation Type		Floor-mount
Rated Voltage		120 V~
Rated Frequency		60 Hz
Rated Power		1200 W (When inlet water temperature is 59 °F)
Power Cord Length		33.46 in
Water Supply Type		G3/4
Water Inlet	Inlet Water Temperature	41 °F ~ 95 °F
	Minimum Pressure	20.3 psi, ensuring a flow of water at least 4.76 GPM
	Maximum pressure	108 psi (static state)
Cleaning	Way for Heating	Instant Heating
	Temperature of Warm Water	Off/about 91.4 °F ~ 102.2 °F (4 levels)
	Safety Devices	Thermostat series, thermal fuse, flow detection device
Dryer	Warm Air Temperature	Off/about 95 °F ~ 129.2 °F (4 levels)
	Safety Devices	Bimetal thermostat series, thermal fuse
Heated Seat	Seat Temperature	Off/about 91.4 °F ~ 102.2 °F (4 levels)
	Safety Devices	Thermal fuse, temperature sensor
Remote Control Battery		Two AAA batteries
Blackout Flush Battery		One 9 V alkaline battery

Warranty

ONE YEAR LIMITED WARRANTY

HOROW products are made with high-quality materials and workmanship to provide customers with products that are built to last. If any defects in material or workmanship are detected during normal use within the first year of purchase, such as the replacement of any product or product part that you consider to be defective, HOROW will provide replacement parts free of charge. We are **not responsible** for all damages that result from **improper installation resulting in unavailability, repair and maintenance**. This warranty applies only to the original purchaser. Proof of purchase and **evidence of damage** will be required in the case of a **claim**.

HOROW recommends the installations to be made by a licensed, professional plumber.

HOROW will not be held responsible for any damage or product failure due to improper installation, misuse, or failure to use a licensed professional. HOROW is not responsible for any removal or installation cost.

This One Year Limited Warranty will be voided if:

The installation recommendations were not followed.

The product has been moved from its initial place of installation.

The product has been modified.

The product has been subjected to improper maintenance, abuse, misuse, excessive use of chemicals, accident or other damages.

HOROW makes no implication that products comply with any or all local building or plumbing codes. It is the consumer's responsibility to determine local code compliance. This warranty extends to the original purchaser and first consumer.

HOROW is not liable for any incidental, consequential or special damages associated with the return, replacement, installation or use of your product. This includes freight costs, labor, travel time, lost profit, home damages and other contingent liabilities and costs (including, without limitation, costs associated with experts, investigations, analyses, attorneys and other professionals and services).

The HOROW warranty is a comprehensive and explicit limit of liability, and all items outside of it are not addressable by or the responsibility of HOROW. Certain states have variances regarding implied warranties and in those situations, we remain fully compliant.

Warranty Registration

Proof of purchase is required to validate this limited warranty. HOROW encourages you to register your product upon purchase to create a record of ownership at www.horow.com. Registration is voluntary and not required to maintain your limited warranty rights.



For any questions or claims, please contact us by phone or email.

Phone: (+1)209-200-8033

Monday to Friday

Email: support@horow.com

When making a claim, please prepare a photo of the evidence of damage so that we can quickly resolve the claim for you.



Warning

Content may contain sharp and other possibly harmful pieces and may cause hazard to children and adults, HOROW is not responsible in any way for personal damage.

