



This guide contains procedures for common user serviceable repair tasks found on interior and exterior doors. If a condition arises that is not covered in this guide, please contact us for professional help.  
Interior and Exterior doors swing in or out on side hinges and may be single or double door configurations.

Do-It-Yourself

Technician



**INTRODUCTION**

**Contact Us**

For questions, feel free to contact us by phone or email:

- Email: customerserviceagents@jeldwen.com
- Phone: (800)-JELD-WEN/(800)-535-3936

**Table of Contents**

[Precautions and Safety](#) .....2

[Tools and Materials](#) .....2

[Slab and Astragal Removal And Installation](#) .....2

[Hardware Replacement and Adjustment](#) .....3

[Weatherstrip Replacement](#) .....4

[Glass Insert Replacement](#) .....5

[Proper Door Installation](#) .....6

[Troubleshooting Operational Problems](#) .....7

[Glossary](#) .....9

**Handing (Shown from Top)**

**Single Panel Door**

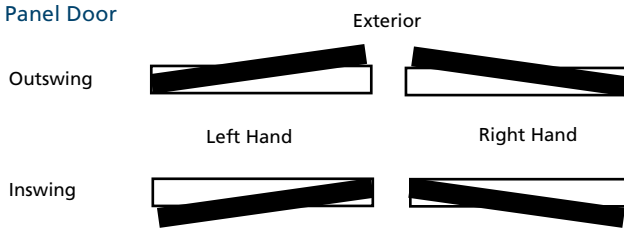

**Double Panel Door**

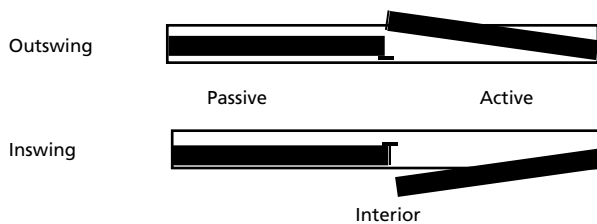

**Single Door Anatomy**

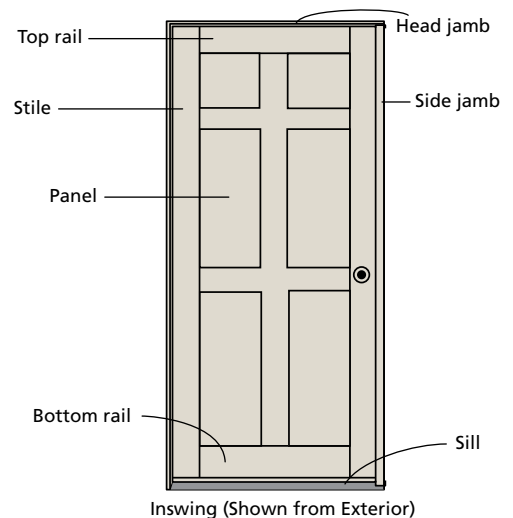

**Double Door Anatomy**

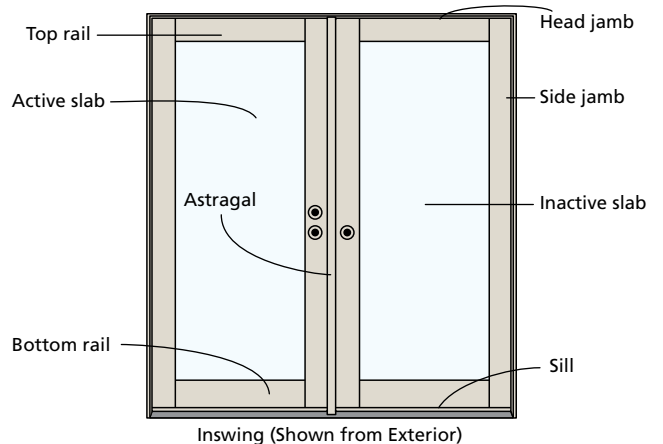

## PRECAUTIONS AND SAFETY

- Follow all manufacturers' instructions and labels.
- Use proper and safe equipment and precautions when cleaning and servicing the exterior side of patio doors above ground level.
- Insect screens are not security devices and will not prevent a child, other person, or pet from falling through.
- Use sharp tools with care to avoid damage to wood surfaces.
- Use extra care when driving screws near glass unit to avoid breakage.
- Use caution when tightening screws to avoid stripping the screw holes.
- Slab removal can be awkward and could cause physical injury or product damage; we recommend the help of a second person.

## TOOLS AND MATERIALS

### Needed Tools

**NOTE: Each tool is not required for every task.**

- #2 Phillips head, square drive, and/or flat head screwdrivers
- Hammer
- Nail set/punch
- Tape measure
- Level
- Utility knife
- Putty knives
- Allen wrenches
- Power drill with bits
- Chisel
- Gloves
- Pliers/side cutters

### Needed Materials

- String
- Tape
- Pencil & paper
- Scissors
- Brad nails
- Shims
- Replacement parts

For Hardware Replacement:

- Wooden toothpicks or dowels
- Wood glue
- Wood putty
- Fine sandpaper
- Finishing supplies
- Silicone sealant

## SLAB AND ASTRAGAL REMOVAL AND INSTALLATION

**Because slab removal can be awkward and could cause physical injury or product damage, we recommend the help of additional people.**

1. Open slab about half way and hold steady with the help of a second person.
2. Only inswing standard door hinges have removable hinge pins. With a small screwdriver or nail punch and hammer, drive hinge pin from bottom hinge, then working up to the top hinge. Doors with automatically closing hinges or outswing doors require removing the screws from one side of the hinge to remove the slab. Take extra precautions when removing the spring loaded automatically closing hinges.
3. Remove slab from frame.
4. To install slab, perform removal steps in reverse order.

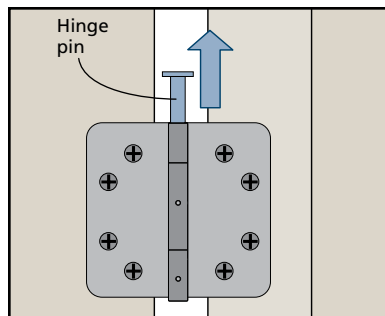

### Astragal Replacement

1. Open the active slab.
2. Remove the screws that attach the astragal.
3. If the astragal doesn't come off, there may be adhesive tape holding it in place. If so, carefully score the joint between the astragal and the slab.
4. Remove the astragal.
5. Fasten the new astragal through the pre-drilled holes in the same location as the old astragal.
6. Install a foam wedge on the passive slab at the bottom with the thick part against the leg of the astragal as shown.

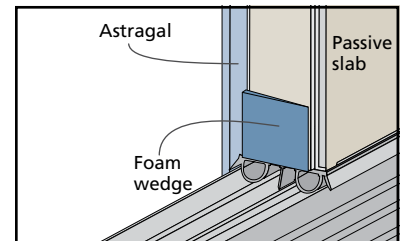
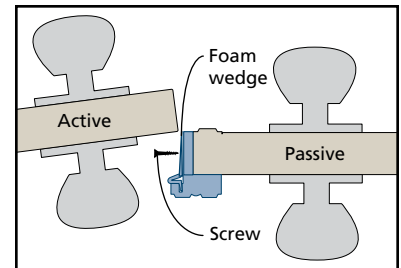

## HARDWARE REPLACEMENT AND ADJUSTMENT

### Hardware Types

- Metal hardware offers functionality, aesthetic appeal and resistance to corrosion but is not totally corrosion proof.
- Plastic hardware offers high resistance to the elements however, over time it can deteriorate from ultraviolet light, heat, cold, and chemical exposure.
- Brass hardware has a special protective film to reduce/eliminate polishing and requires special care.
- See our complete Care and Maintenance document at [www.jeld-wen.com](http://www.jeld-wen.com) for more information on cleaning and lubricating hardware.

Screw hole repair and hardware alignment, or realignment, are common tasks for any hardware replacement component. Follow these instructions if screw holes become stripped and/or if hardware no longer functions properly due to misalignment.

### Screw Hole Repair (in wood only)

1. Cut wooden toothpicks or appropriate sized wood dowel to fit screw hole just below wood surface.
2. Fill screw hole with wood glue.
3. Insert toothpicks or dowel and let dry.
4. Fill to surface with wood putty and let dry.
5. Sand smooth and refinish and let dry.
6. Drill the new pilot hole.

### Hardware Alignment (in wood only)

Misalignment can happen if screws have become stripped and cannot be tightened. This alignment will create new screw holes.

1. Remove hardware.
2. Repair screw holes according to the procedure above.
3. Mark new screw holes as follows:
  - Lay hardware in position and hold in place.
  - Mark new screw locations through screw holes.
  - Remove hardware and set aside.
4. Drill pilot holes with 1/16" drill bit at new marked screw hole positions no deeper than screw length.
5. Install hardware.
6. Test operation; if not operating properly, call us for assistance.

### Hinge Replacement and Adjustment

#### Replacement

1. Remove slab.
2. Remove hinge plates from slab.
3. Repair screw holes as instructed above if stripped.
4. Install new hinge plates in the same locations.
5. Reinstall slab.

#### Adjustment (Spring Hinges Only)

1. Close door.
2. Insert the provided hex wrench so that it can be rotated clockwise.
3. Rotate hex wrench 1/4 turn and insert tension pin loosely into tension hole.
4. Remove hex wrench and try closing force.
5. Repeat steps until closing force is adequate but do not rotate past 3 holes on 180° openings or 4 holes on 90° openings.

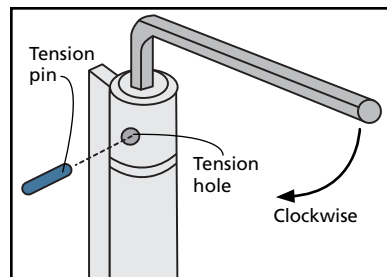

### Blinds Between the glass

For easiest operation, keep the slats in a fully open position while operating.

#### Adjustments

1. If the operator comes off of the track, hold the operator at a sharp angle to the glass and reinsert the two legs under the track opening.
2. Re-couple the operator magnets.

#### Re-couple Operator Magnets

1. Slide the operator past the half-way engagement point until the first click.
2. Full travel blinds will fully engage when you hear the first click. Half travel (those units with a single side operation) will require you to continue moving the operator up until you hear the second click. This will ensure the magnets are fully engaged.

### MECHANISM REPLACEMENT

#### Raise and Lower Mechanism

1. Place a piece of cardboard between the slide mechanism and the glass to help release the magnets.
2. Tilt the mechanism toward you, and remove the mechanism. It may require a strong tug to break the magnetic bond.
3. Before replacing the new slide mechanism, ensure the glass is clean.
4. Insert the tabs underneath the lip of the inner frame and raise the slide to the top until the magnets engage.
  - a. Full travel blinds will fully engage when you hear the first click.
  - b. Half travel (those units with a single side operation) will require you to continue the travel of the operator up until you hear the second click. This will ensure the magnets are fully engaged.
5. Check for proper operation. Remove and reinstall if necessary.

#### Tilt Mechanism

1. Move the top helix to the left side. Moving the slider magnet on the outside of the glass can do this. The helix tilt operator has a magnet set which will follow the magnet inside the slide mechanism.
2. Clean the glass attaching area.
3. Peel off the tape on the back of the slider.
4. Before application, push the magnet to the left of the slider. Ensure the slider is facing the right direction (there is a long horizontal gap at the top that allows the magnet housing to slide along the base).
5. Let the magnet be attracted to the left side of the magnet, which is inside the glass. Make sure the slide is horizontal.
6. Push the slide against the glass firmly on the tape area, as the adhesive works under pressure.

### Threshold adjustment (adjustable thresholds only)

**Note! Adjusting the threshold may break sealant joints at the ends and/or interfere with the foam wedges if installed. Adjust threshold, then replace these components as necessary. See "Foam Wedges" in the Weatherstrip Replacement section below for details.**

Adjustable thresholds will have adjustment screw covers or exposed screws on the top where the door slab contacts the threshold when closed. Verify the sweep properly contacts the threshold with 1/8" compression as shown. If adjustment is needed, use a flat head screwdriver to remove screw covers. Turn all screws clockwise to adjust up; counterclockwise to move down until desired height is achieved and the threshold is level.

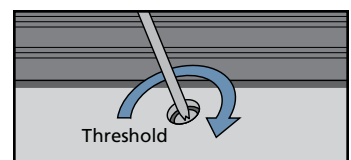
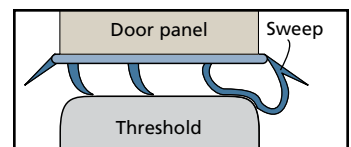

## WEATHERSTRIP REPLACEMENT

### Ordering New Weatherstrip

Weatherstrip gaskets and foam wedges are critical to water and air infiltration control. Check placement and quality of weatherstrip. Replace if damaged.

Fire-rated doors require specific weatherstrip. Please contact us if replacing weatherstrip in a fire-rated door.

Doors will have weatherstrip in the frame where the slab(s) are when normally closed. Some doors have a sweep attached to the bottom of the operating panel where it contacts the threshold. Double doors will have weatherstrip in the astragal.

1. Determine amount needed by measuring each piece to be replaced. Note the location on the door of each type of weatherstrip.
2. For each type of weatherstrip, add all measurements, then add an additional 10%.
3. Round up to the nearest foot.
4. Fill out the following table.

Information for Replacement Weatherstrip	
Product Identification	
Weatherstrip Location	
Weatherstrip Type	
Color	
Amount Needed	

5. Purchase new weatherstrip from a local supplier.

### Frame/Threshold/Astragal/Mullion Weatherstrip

When replacing both the side and the head weatherstrip in the frame, install head weatherstrip first. Astragal weatherstrip runs vertically along the astragal (between the two slabs of double doors).

1. Open active panel.
2. Grip weatherstrip and gently pull out of kerf.

When replacing frame weatherstrip, if applicable, trim and overlap the new weatherstrip in the same way as the old weatherstrip.

1. Cut new weatherstrip to length.
2. Work the attachment barb into the kerf from one end to the other.

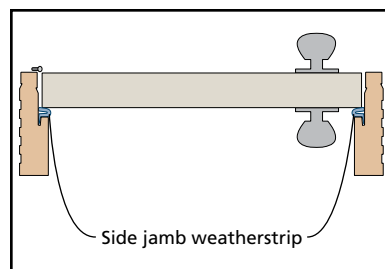
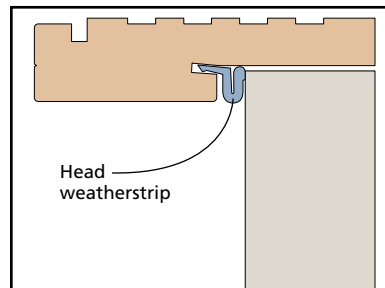

### Possible Weatherstrip Locations on Double Doors

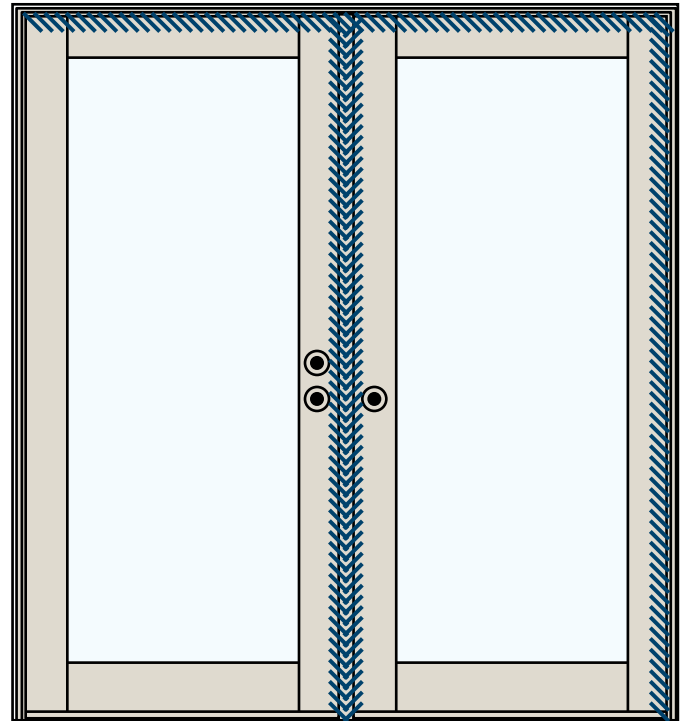

### Door Sweep (Inswing Doors Only)

The door sweep is mounted on the bottom of the door slab and fills the gap between the threshold and the slab. Due to continual contact with the threshold, the door sweep may lose its shape and cease to provide an effective seal.

1. Remove slab.
2. Lay slab on flat padded work surface.
3. Remove staples in door sweep with needle nose pliers or side cutters.
4. Pull door sweep loose by starting at one end and working to the other.
5. Clean old sealant off rail with putty knife.
6. Trim new door sweep to same length as the existing one.
7. Cover face (the side with the barbs) of new door sweep with silicone sealant.
8. Work attachment barbs into kerfs from one end of the panel to the other.
9. Secure sweep to the door panel with staples and wipe off sealant squeeze-out. Seal the sweep on both ends with silicone sealant. Reinstall slab.

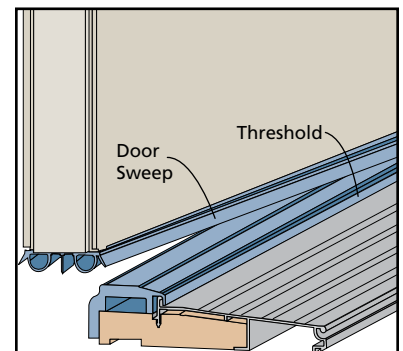

## WEATHERSTRIP REPLACEMENT - CONTINUED

### Astragal Weatherstrip

1. Open active door all the way.
2. Locate the accessible weatherstrip.
3. Grip weatherstrip and gently pull out of kerf.
4. Cut new weatherstrip to length.
5. Work the attachment barb into the kerf from one end to the other.

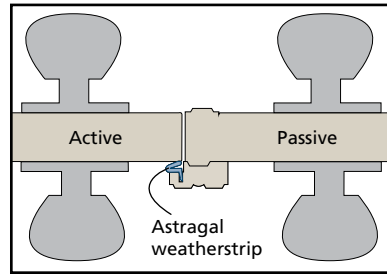

### Foam Wedges

The foam wedges are used to complete the weatherstrip seal, at each bottom corner of the operating door slab(s). Doors are provided with one of two types of wedges. One has an up-turned L-shaped leg and the other doesn't (shown). Contact us for the appropriate replacement. For both types, the thin edge faces the edge of the door as it swings closed. Apply a bead of sealant (remove old sealant first if necessary) at the intersection of the jambs, brickmoulds, thresholds and floor as shown.

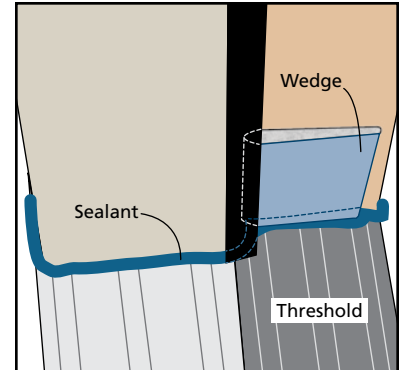

## GLASS INSERT REPLACEMENT

### Remove Old Glass Insert

**NOTE: Handling glass can be dangerous. Glass inserts can be heavy and awkward. Use additional help and always wear protective clothing.**

1. If the old insert has screw plugs over the screw heads in the interior frame, drive a drywall screw into the screw plug until it is loose from the hole. Remove all remaining screw plugs in the same manner.
2. Support the glass insert while removing screws to keep it from falling. Remove the screws from the interior frame from the bottom up.
3. When all the screws are removed, slide the edge of a putty knife between a top corner of the interior frame and door. Work around the entire perimeter until the interior frame is loose.
4. Repeat this procedure around the exterior frame. Remove the glass insert and set aside in a safe location.
5. Clean both sides of the door where the new glass insert will contact the panel with a clean rag dampened with paint thinner. Remove all the old weatherstrip and then wipe again with a clean rag.

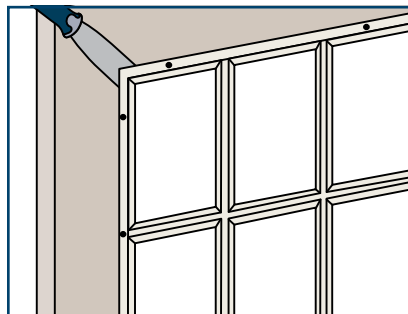
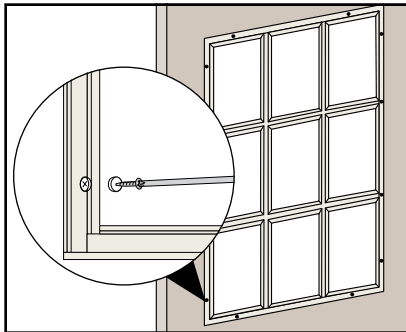

### Install New Glass Insert

**NOTE: The exterior frame is attached to the glass and does not have holes; the interior frame has screw holes.**

1. Remove packaging materials from the new insert. If shipping screws are holding the unit together, separate the interior and exterior frames by loosening screws. Leave the screws in the interior frame and set aside. Additional screws are provided to complete assembly.
2. Place the lower portion of the exterior frame and glass on the lower edge of the door opening. Horizontally center the frame and glass into the opening and tilt up until the frame is flush against the door.
3. Position the interior frame in the opening using the press fit alignment pins located on the frame.
4. Secure the frame halves together by driving the screws through the interior frame and into the exterior head frame with a Phillips head screwdriver until snug. Power drivers can be used on the lowest torque setting. Screws must then be checked with a hand screwdriver.
5. Finishing instructions are provided on the label attached to the door glass. Please read this BEFORE removing the label.
6. Insert the provided screw hole plugs over all exposed screw heads.
7. Clean glass with mild soap and water.

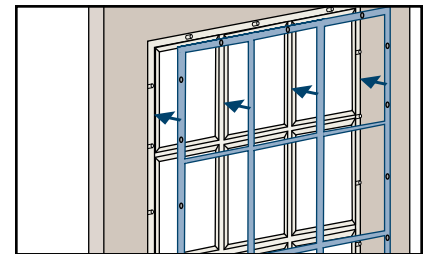
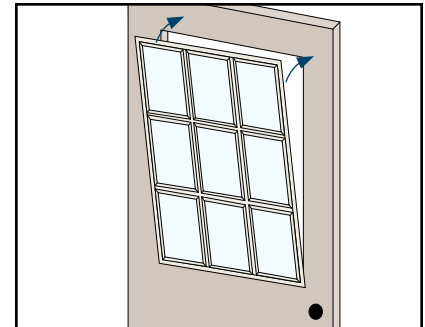

## PROPER DOOR INSTALLATION

- Proper installation is essential for keeping doors operating smoothly. If a door fails to operate properly, an inspection is necessary to determine if it was installed correctly.
- A contractor or installer can assist in determining the cause of a door being “out of specification” and possibly correct it. Door problems due to improper installation are usually not covered by the manufacturer’s warranty. For installation instructions, contact us or your supplier.
- The specifications and measurements referenced in this guide are taken from ASTM E2112 Standard Practice for Installation of Exterior Windows, Doors and Skylights.

**NOTE:** These instructions do not address inspection for proper “water tightness” or flashing where the product integrates with the structure. A “water tight” inspection requires removal of the exterior siding and interior trim around the door. Seek professional assistance regarding this issue.

### Level Indicator

Accurate measurements are essential in determining level and plumb. Most carpenters’ levels have several bubble level indicators, making it possible to measure all parts of the door.

Examine the horizontal indicator. If the bubble is centered between the lines of the indicator, it is level.

If the bubble is not exactly centered, measure how far “out of level” or “out of plumb” by maneuvering the end of the level until the bubble is exactly centered. Measure the farthest gap between the level and the surface. On a 4’ level (or longer), the gap must not exceed 1/4”, or the surface is out of level/plumb.

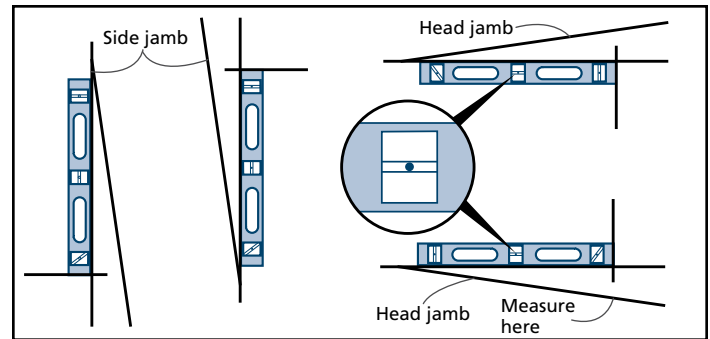

### Square

Measure frame from top left to bottom right corner and from top right to bottom left corner. If measurements differ by 1/8”, unit is out-of-square.

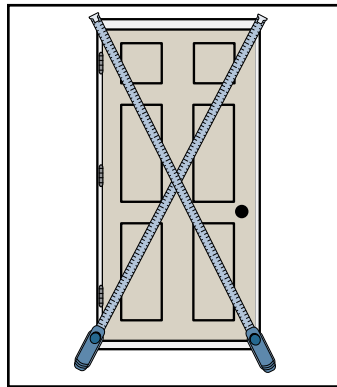

### Frame Twists

Attach two pieces of string to frame, corner to corner. If there is a gap between strings at center point larger than 1/8”, the frame is not flat. Repeat by switching strings and re-measuring.

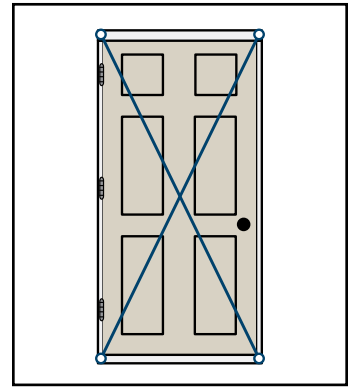

### Level and Plumb

For plumb, place level against each side jamb or use a plumb bob. For level, place level against head jamb and sill.

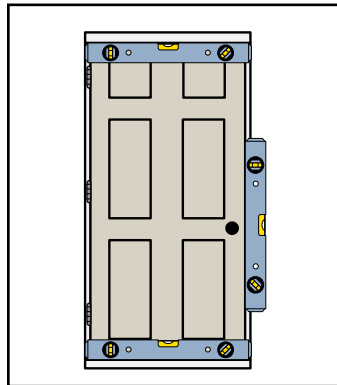

### Proper Shimming

Measure width of frame at top, center, and bottom. If any two measurements differ more than 1/16”, the frame is over or under shimmed. Repeat process and measure height of frame.

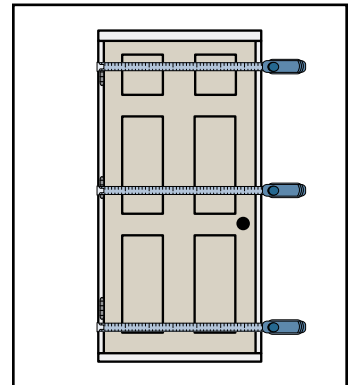

**PROPER DOOR INSTALLATION - CONTINUED**

**Straight Side Jamb**

Place level against inside of side jamb. Look for gaps anywhere between level and side jamb. Repeat steps for other side jamb.

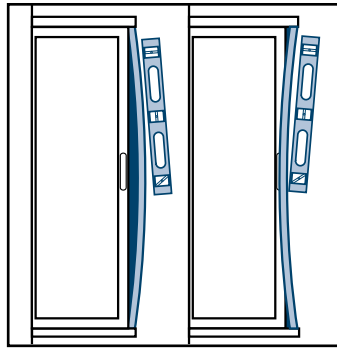

**Frame/Panel Bow**

Inspect interior and exterior frame jambs, or stiles/rails of slab (not glass) to determine if bowed.

1. Cut piece of string slightly longer than height of frame or slab.
2. Pull tightly and stretch string to upper and lower corners of jambs, or, stiles or rails of slab. Tape securely.
3. Look for gap between string and frame or slab. If gap measures more than 1/4" at any point, the slab is bowed.

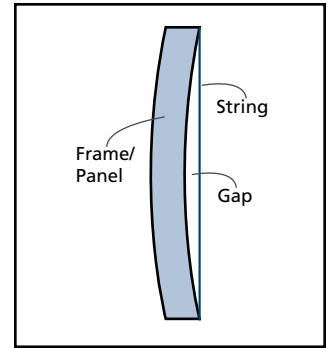

**TROUBLESHOOTING OPERATIONAL PROBLEMS**

**NOTE: Please check each possible cause, including verifying proper installation, before contacting us for assistance.**

PROBLEM	POSSIBLE CAUSES	POSSIBLE SOLUTIONS
Door will not open	Knob locked	Make sure lock is in unlocked position, try again
	Obstructions	Remove obstructions/shipping blocks
	Slab damaged	Repair or replace slab
	Lockset damaged or broken	Replace lockset
	Strike plate loose or damaged	Tighten if loose, replace if damaged
	Improper installation	Inspect installation
Door will not close	Threshold dirty or damaged	Clean threshold then lubricate with silicone spray on cloth
	Deadbolt in locked position	Make sure lock latch is in unlocked position, try again
	Obstructions	Remove obstructions/debris/shipping blocks
	Strike plate loose or damaged	Tighten if loose, replace if damaged
	Lock strike plate misaligned	<ul style="list-style-type: none"> <li>• Realign. Create new screw holes and chisel bore if necessary</li> <li>• Make shoot bolt lock strikes flush to sill (double doors)</li> </ul>
	Weatherstrip loose or damaged	Reattach if loose, replace if damaged
	Frame bowed	Inspect Installation
	Improper installation	Inspect installation
Door swings open by itself	Slab not plumb	Inspect Installation
	Hinge plates not flush with frame or slab	Make hinge plates flush
	Hinge screws not flush with hinge plates	Ensure proper hinge placement; tighten screws
Uneven reveal (gap) between slab & frame	Slab(s) not aligned properly	<ul style="list-style-type: none"> <li>• Adjust threshold if adjustable</li> <li>• Make hinge plates flush (hinged doors)</li> <li>• Ensure proper hinge placement (hinged doors)</li> </ul>
	Improper installation	Inspect installation
Door stuck shut	Slab(s) misaligned	Remove obstructions/shipping blocks
	Slab painted to weatherstrip	Un-stick painted-over weatherstrip



**TROUBLESHOOTING OPERATIONAL PROBLEMS - CONTINUED**

PROBLEM	POSSIBLE CAUSES	POSSIBLE SOLUTIONS
Door will not lock	Lock misaligned	<ul style="list-style-type: none"> <li>Align lock strikes</li> <li>Make shoot bolt lock strikes flush to sill (double doors)</li> </ul>
	Improper installation	Inspect installation
Door squeaks	No lubricant on hinges	Lubricate all hinges with light oil
Light or air leaks through corners	Worn weatherstrip	Repair loose or damaged weatherstrip
	Foam wedge damaged or missing	Replace foam wedge
	Hinges may be worn or misaligned	Replace hinges. Ensure proper hinge placement
Door handle will not operate	Improper installation, damaged or misaligned	<ul style="list-style-type: none"> <li>Check for damage/lubricate if necessary</li> <li>Check alignment of strike plate. Re-align if necessary</li> </ul>
Shoot bolt will not fully engage	Lock strike obstructed or not deep enough to allow shoot bolt to fully engage	Clear any debris and verify shoot bolt lock strikes flush to sill
Water leaks through the door	Slab damaged or loose at hinges	Replace slab
	Weatherstrip damaged or missing	Reattach if loose, replace if damaged or missing
	Slab warped or bowed	Inspect installation
Moisture occurs between glass panes	Seal failure	Replace either the insulating glass assembly or the entire slab. This determination should be made by a service representative.
Glass surface fogs up	Condensation	<p>If condensation is on an interior surface:</p> <ul style="list-style-type: none"> <li>Raise the average temperature of the house one or two degrees and do not block vents.</li> <li>Vent all appliances to the outdoors and run exhaust fans.</li> <li>Open patio door blinds for air circulation.</li> <li>Turn humidifiers down as the temperature gets colder (unless used for medical purposes).</li> </ul> <p>If condensation is on an exterior surface:</p> <ul style="list-style-type: none"> <li>Close patio door coverings to reduce cooling of the glass surface by air-conditioning.</li> <li>Remove or trim shrubbery close to patio doors to promote air circulation.</li> </ul> <p>If condensation is between glass panes:</p> <ul style="list-style-type: none"> <li>Seal failure. Replace either the insulating glass assembly or the entire slab. This determination should be made by a service representative.</li> </ul>



## GLOSSARY

**Active Slab**

Active slab(s) are any slab(s) on double door systems that operate and include locking hardware.

**Astragal**

The vertical trim attached to the inactive slab of a double door that bridges the gap between the slabs when closed and provides weather and overswing protection.

**Boot-glaze**

The method by which glass is set and sealed into a panel with a rubber-like beige or gray gasket ("boot").

**Door Sweep**

Weatherstrip that attaches to the bottom of a swinging patio door panel, providing a barrier against the elements.

**Frame**

The assembly of structural members (head, sill, and jambs) used to fasten the window/patio door to the structure.

**Handing**

The operating direction of an entry door; refers to the way the entry door will swing or slide to open (right-handed or left-handed).

**Hinge**

A jointed or flexible device on which a door or window turns.

**Hinge Pin**

A pin in the center of a hinge that holds the two parts together and allows them to pivot.

**Jamb**

The vertical frame members of a window or patio door assembly.

**Kerf**

A groove that often holds weatherstrip.

**Keyway**

The slot in the lock where the key is inserted.

**Lock Jamb**

The side jamb that houses the lock strike plate; the door slab closes into the lock jamb.

**Passive Slab**

The slab of a double door system that has the astragal mounted to it; the active slab locks into the passive slab.

**Pilot Hole**

A drilled hole that is no larger than the body of the screw (minus the threads).

**Rail**

The horizontal members of a door slab.

**Reveal**

The space between the slab and the frame.

**Score**

To inscribe a line with a sharp instrument.

**Shoot Bolt**

A locking component which, when activated, extends vertically from the end of an inactive slab and engages a strike plate in the head and sill of the frame.

**Slab**

An assembly comprised of stiles (vertical pieces), rails (horizontal pieces) that is installed into a frame.

**Stile**

The vertical members of a door slab.

**Strike Plate**

A bracket fixed to the frame utilized as a latching point for locking systems.

**Weatherstrip**

A strip of flexible material that fills the joint between the door slab and the frame and is used to prevent rain, snow, and air from entering.

The repair tasks offered herein can be accomplished by a homeowner with some mechanical aptitude. If you are unsure, it is recommended that you hire a trained service provider such as a competent and licensed construction contractor or building professional. JELD-WEN disclaims any and all liability associated with the use and/or provision of these instructions. Any reliance upon the information or advice is at the risk of the party so relying. The information contained herein may be changed from time to time without notification.