

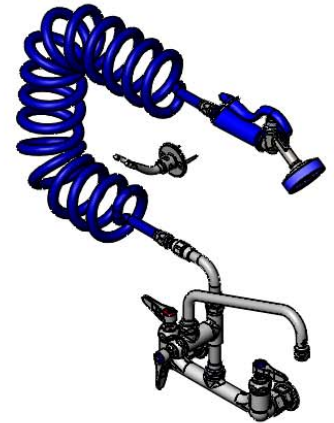

**Architect/Engineering Specifications:**

8" wall mount mixing faucet, compression cartridges with spring checks, lever handles, add-on faucet with compression cartridge and lever handle, 10" swing nozzle with stream regulator outlet, 90 degree swivel adapter, 9 ft coiled hose with angled aluminum spray valve, hose hanger hook, and 1/2" NPT female inlets. Certified to ASME A112.18.1 / CSA B125.1.

Job Name \_\_\_\_\_  
 Model Specified \_\_\_\_\_ Quantity \_\_\_\_\_  
 Variations Specified \_\_\_\_\_  
 Date \_\_\_\_\_

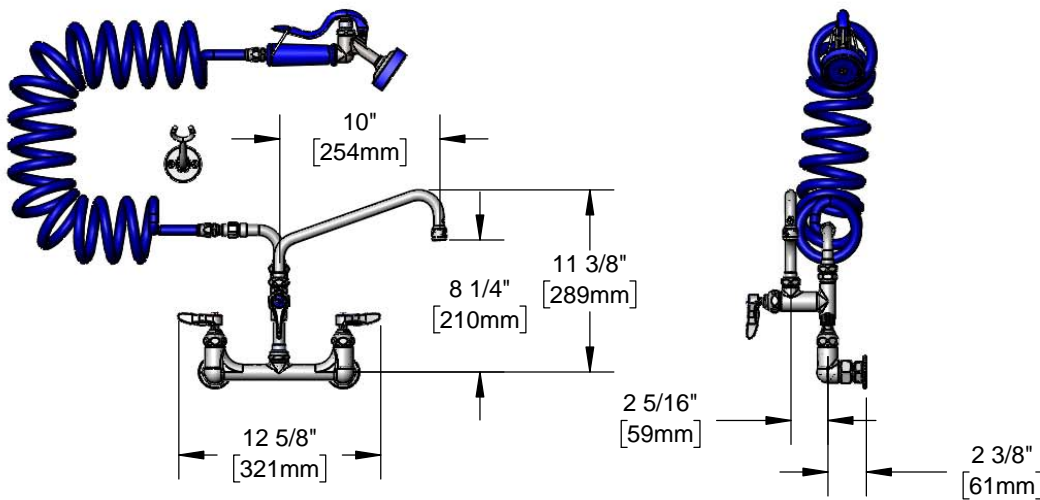

**Features & Benefits:**

- 8" wall mount mixing faucet w/ chrome plated brass body
- Quarter-turn Eterna cartridges w/ spring checks to prevent cross flow of water
- Lever handles w/ color coded indexes
- EasyInstall add-on faucet w/ polished chrome plated brass body
- 10" swing nozzle w/ stream regulator outlet, Series 1
- 90° swivel adapter
- 9 ft coiled hose w/ angled aluminum spray valve
- Hose hanger hook w/ mounting screws
- Wall bracket
- 1/2" NPT female Inlets
- Materials: Chrome plated body & tubular spout, chrome plated metal handles, polyurethane hose and aluminum spray valve

**Product Compliance:**

- ASME A112.18.1 / CSA B125.1
- NSF 61 Exempt (Non-Potable)



**Warranty:** One Year (Limited)

**Performance Data:**

- Pressure: 20 - 125 psi
- Temperature: 40 °F - 140 °F
- Flow Rate:  
 Spray Valve: 4.12 GPM @ 60 psi  
 Swing Nozzle: 9.73 GPM @ 60 psi

**Optional Add-On Faucet Outlets (Series 1 / VR Series 6)**

GPM	Aerated	VR Aerated
1.0	<input type="checkbox"/> B-0199-01-F10	<input type="checkbox"/> B-0199-06-F10
1.5	<input type="checkbox"/> B-0199-01-WS	<input type="checkbox"/> B-0199-06-WS
2.2	<input type="checkbox"/> B-0199-01	<input type="checkbox"/> B-0199-06

**Optional Handles**

- 4" Wrist Action
- Lever (Standard)
- 4-Arm

**Optional Cartridges With Checks**

- Quarter-Turn Cerama w/ Check Valve
- Quarter-Turn Eterna w/ Spring Check (Standard)

