

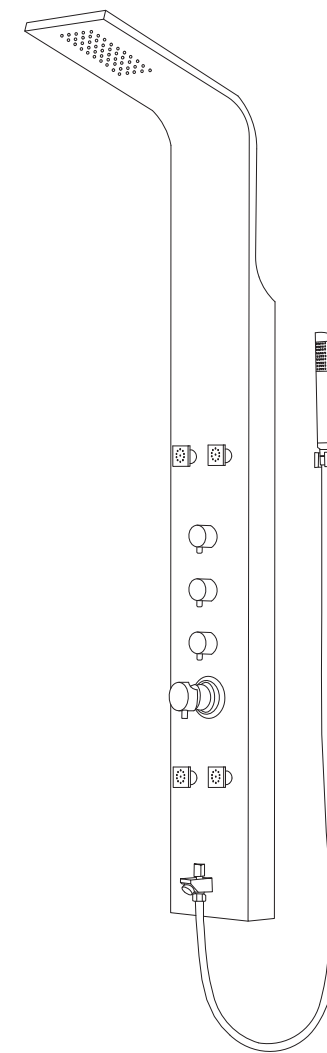

INSTALLATION AND USER'S GUIDE



Shower Panel

Please carefully read these instructions before you begin to install the products.

CET ARTICLE N'EST PLUS GARANTIE SI INSTALLÉ AVEC UN DÉFAUT VISUEL EVIDENT
THE WARRANTY WILL BE VOID IF THIS ITEM IS INSTALLED WITH OBVIOUS VISUAL DEFECTS.





TABLE OF CONTENTS

Packaging Check List.....	2
Installation.....	3-5
Trouble Shooting.....	6
Parts List.....	7
User instruction.....	8-9
Scale removal & Technical data	10

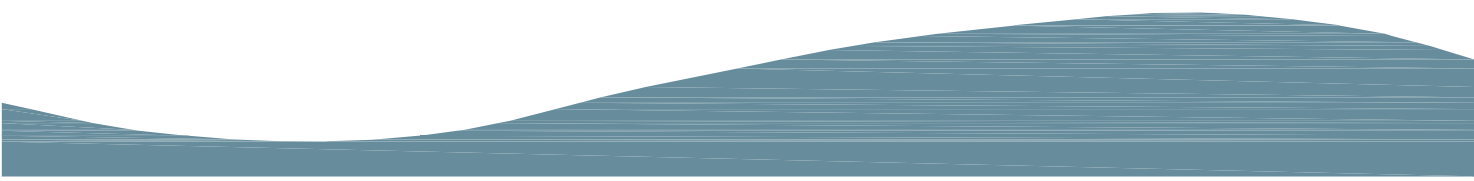

Packaging Check List

When you open the box, you will find the following pieces:

- 1 piece of shower panel body with all jets, valves installed
- 1 piece of handheld shower & 1 flex. hose with 2 rubber gaskets
- 1 piece of handheld shower hook with 2 screws (M4x20) and 2 anchors (6mm)
- 2 pieces of water supply flex.hose (F1/2"X3/8" Comp)
- 1 set of mounting hard ware including 2 brackets, 6 screws (M5x30) and 6 anchors (8mm)
- 1 booklet of installation & user manual

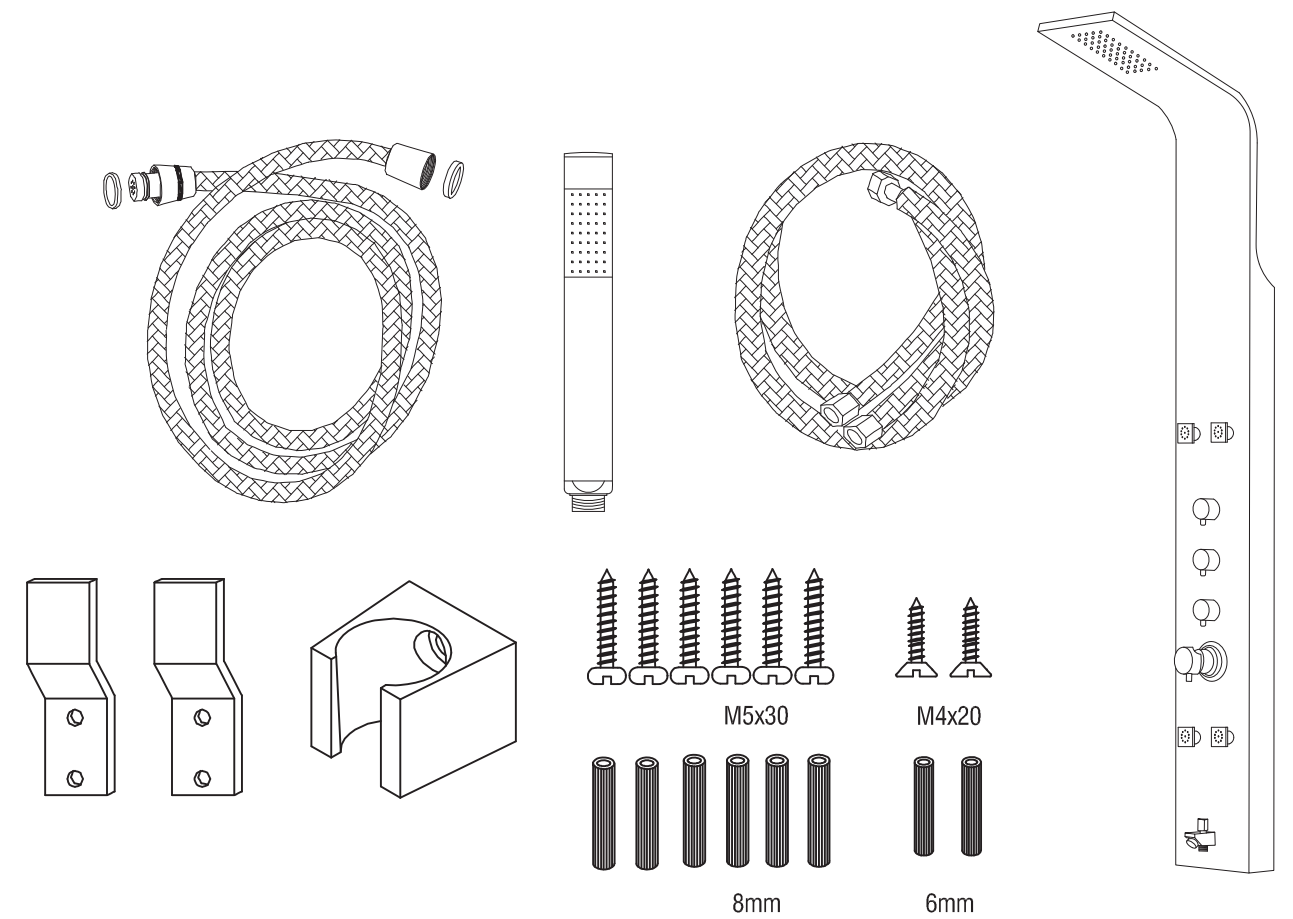

ATTENTION: before installing the shower panel, make sure that you have a 25 psi water pressure in your water supply system

Preparation for installation

The tools for installing a shower panel includes the those on the right. One person and an assistant are recommended for an easy installation.

Silicon is not necessary for installing this shower panel, however you may glue the panel on the wall with silicon.

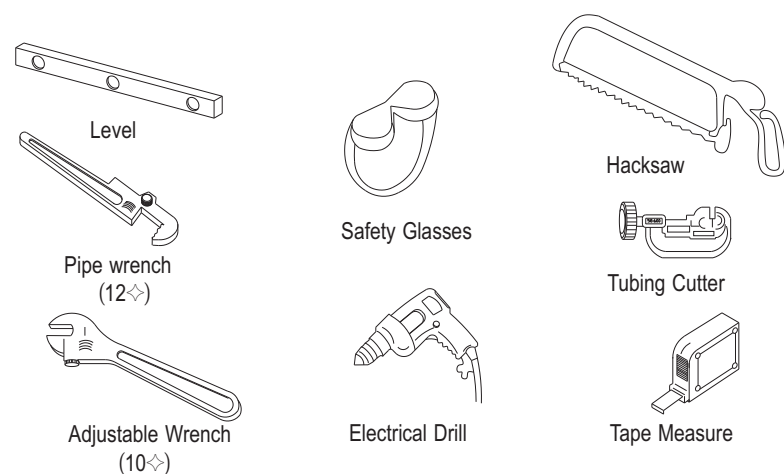

Attention: This shower panel is designed for flat wall mounting.

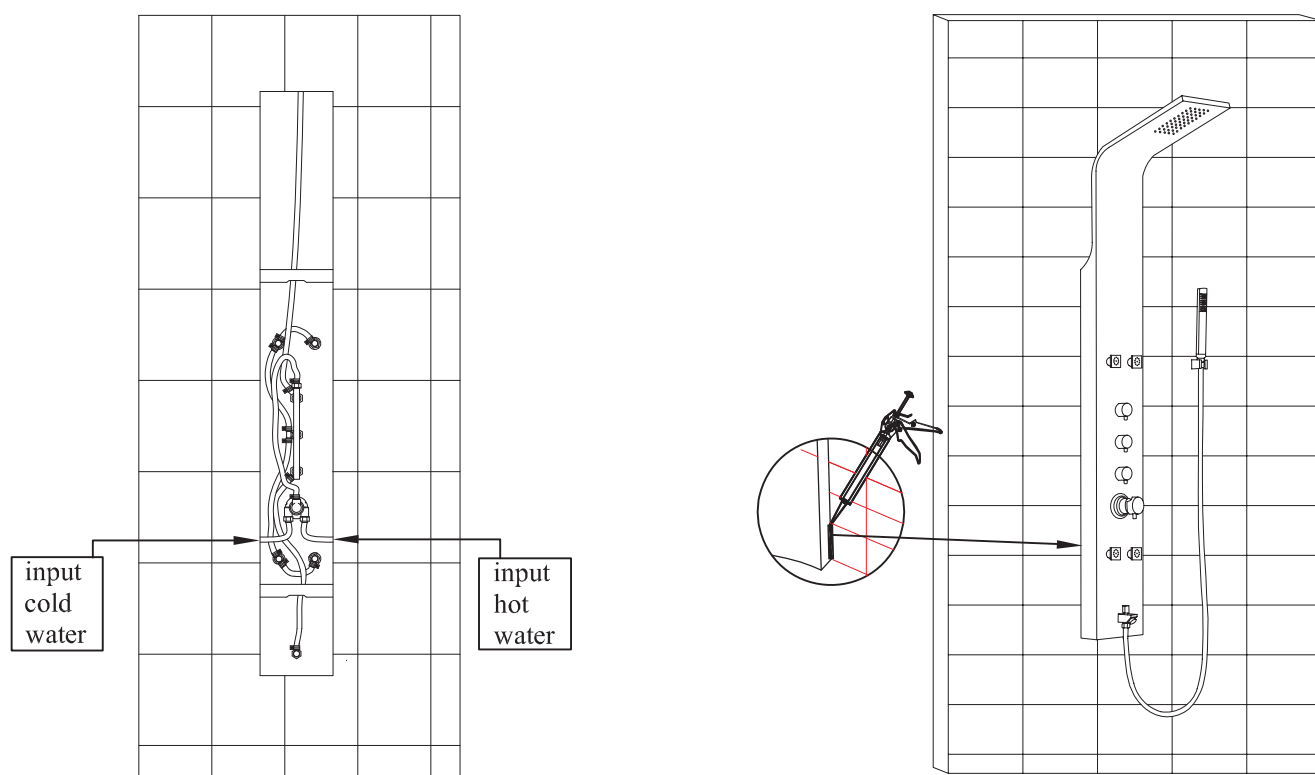

NOTE (critical steps to ensure your shower panel function properly)

- (1) make sure the cold water connect to cold water input end of control valve with a BLUE TAB and the hot water to the hot water input end with a RED TAB.
- (2) do not drop the back flow filters on both ends of control valve when you take away the TAB.
- (3) rinse out of all remaining debris and dirt in the house water supply system or the cartridge inside the thermostat valve will be damaged easily.

Requesting service

If you require service:

1. Contact the dealer or contractor who sold and installed the product. They should be able to solve any problems you may have.
2. If your dealer or contractor cannot solve the problem, they will contact or supply you with the name of the OVE DECORS Distributor.
3. If you are unable to obtain warranty service through either your contractor or OVE DECORS distributor, please write us directly at:

OVE DECORS
2800 Etienne Lenoir
Laval, Québec
Canada, H7R 0A3
Customer Service Department (1-866-839-2888)
www.ovedecors.com

4. Include all pertinent information regarding your claim;

A complete description of the product, Model numbers, colors, finishes, and the date the product was installed.

A description of the problem and a photocopy of your invoice and purchase receipts for the products involved.

Also please provide the name and contact telephone numbers of the contractor and distributor.

Please note that under any circumstances, OVE DECORS products should not be returned to your dealer, distributor or directly to OVE DECORS without a written Return Merchandise Authorization (RMA).

Appels de service

Si vous avez besoin d'assistance:

1. Communiquez avec le détaillant ou l'entrepreneur qui vous a vendu et installé le produit. Il devrait être en mesure de résoudre tout problème que vous pourriez rencontrer.
2. Si le détaillant ou l'entrepreneur ne peut résoudre le problème, il devrait pouvoir vous fournir le nom du distributeur local OVE DECORS.
3. Si vous ne pouvez obtenir le service requis auprès de l'entrepreneur ou du distributeur OVE DECORS, veuillez nous écrire à :

OVE DECORS
2800, rue Étienne-Lenoir
Laval (Québec) H7R 0A3
Canada
Service à la clientèle Tél. : 1-866-839-2888
www.ovedecors.com

4. Inclure toute l'information pertinente concernant votre réclamation :

Une description complète du produit
Les numéros de modèles, de couleurs et de finitions, ainsi que la date d'installation du produit.

Une description du problème accompagnée d'une photocopie de votre facture avec preuve(s) d'achat pour le(s) produit(s) concerné(s).

Veillez également fournir le nom et numéro de téléphone de l'entrepreneur ou du distributeur.

Veillez prendre note qu'en aucun cas les produits OVE DECORS ne doivent être retournés à votre détaillant, distributeur ou directement à OVE DECORS sans le document d'autorisation de retour de marchandise.

Care and maintenance

Clean the outside surface of your shower with mild soap. Wipe the entire surface completely dry with a clean soft cloth. Do not use any abrasive cleaners wire brushes as they will scratch and dull the surface and the metal of the product.

OVE DECORS LIMITED ONE 1-YEAR WARRANTY

This warranty extends only to the original owner/end-user for personal household use only. For commercial uses additional limitations may apply.

OVE DECORS warrants the product under normal use and service for a period of one year from the purchase date.

Please note that OVE DECORS is not responsible for installation or removal costs. Modification of any seat components may void the warranty. This warranty does not cover any claim arising from abuse, misuse, negligence, accident improper installation or operations on the part of the purchaser.

Implied warranties including that of merchantability or fitness for a particular purpose, are expressly limited in duration to the duration of this warranty. OVE DECORS disclaims any liability for special, incidental, or consequential damages.

Soin et entretien

Nettoyez la surface extérieure de votre douche avec un savon léger. Essuyez la surface entièrement sèche avec un tissu mou et propre. N'utilisez pas des produits de nettoyage abrasifs grattoirs brosses métalliques pour éviter d'gratigner ou d'endommager la surface du produit.

GARANTIE LIMITÉE D'UN 1 AN OVE DECORS

Cette garantie s'applique uniquement au propriétaire/utilisateur d'origine des fins domestiques seulement. L'utilisation des fins commerciales peut affecter les limites de la garantie. OVE DECORS garantit le produit dans des conditions normales d'utilisation et d'entretien pendant une période de un an à compter de la date d'achat.

OVE DECORS réparera, remplacera ou effectuera les corrections nécessaires à son choix après inspection facultative de sa part, de toute défectuosité survenant dans des conditions normales d'utilisation durant les périodes de garantie.

Veuillez prendre note que OVE DECORS n'est pas responsable des frais d'installation ou de retrait.

Toute modification de toute composante du siège peut entraîner l'annulation de la garantie. La garantie n'inclut pas les réclamations résultant d'abus d'utilisation inadéquates de négligence d'accident d'installation ou de manoeuvre inadéquates de la part de l'acheteur.

Les garanties tacites incluant la qualité marchande ou l'utilisation pour un usage particulier sont expressément limitées. La durée de cette garantie OVE DECORS décline toute responsabilité pour dommage particulier, accidentel ou indirect.

How to install a panel.

(1)

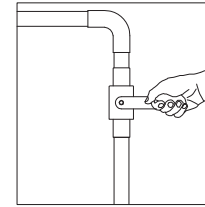

(2)

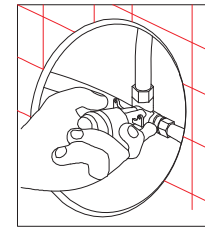

(3)

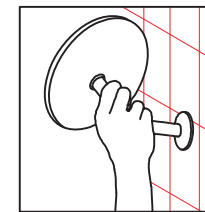

(4)

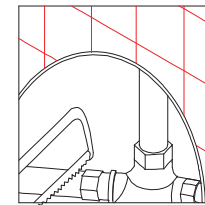

(5)

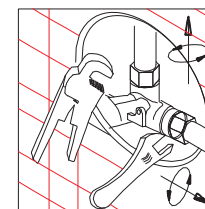

(6)

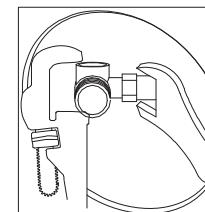

(7)

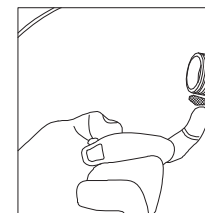

CAUTION: All the pictures and written information in the manual could be different from the actual product and just for the user's reference. We will not take any responsibility for any inaccurate information in this manual.

- Shut off the water at the main using a curb key.
- Close the valves at the water heater (Figure 1).
- Next, turn off the power to the water heater.
- Open the hot and cold at the bathroom faucet to relieve the pressure in the lines.
- Then, open the valve to let the remaining water out (Figure 2). Make sure all the remains or debris or dirt are released or cleaned out. Or the thermostat or diverter valve might be easily damaged.
- Remove the shower arm using slip-joint pliers to loosen it first (figure 3).
- Remove any parts you can from the valve body.
- Use a hacksaw to cut the water line where you can leave as much copper pipe as possible above the valve body (figure 4), then cut either the hot or cold line.
- Using slip-joint pliers, unscrew the old valve off the male adapter and remove (figure 5).
- Install a compression fitting to replace the adapter that was just removed from the hot or cold line. Install a 3/8" male adapter if your copper pipe is not 3/8" in diameter (figure 6).
- Apply Teflon paste to the threads on the end of the cold and hot water line (figure 7).

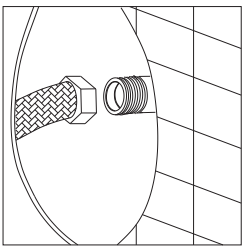
- (8)  ■ Connect the supplied 3ft 3/8" Comp x 1/2" Comp hose and tighten the female adapters to the threads (figure 8) then tighten down with pliers
- Hanging the Body Shower:

Before installing the anchors place a piece of painters tape over the spot where you'll be drilling the hole. This helps prevent damage to the tile.

Using your drill with a tile bit drill the hole into the tile

Apply silicone caulk to the anchor for a good seal Follow the manufacturers instructions when installing anchors.

Place the anchor into the hole then set the screw.

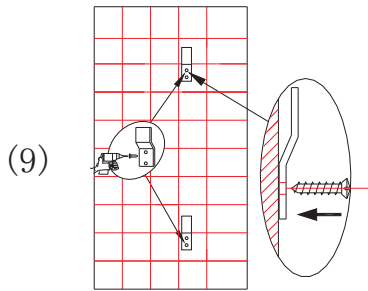

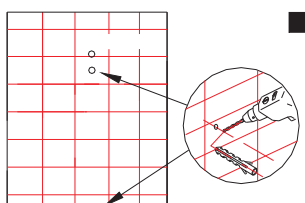
- (10)  ■ Attach the 3ft 3/8" Comp x 1/2" Comp hose to the adapters of control valve in the back of panel body the tighten with pliers PLEASE NOTE THE HOT LINE MUST CONNECT TO THE ADAPTER WITH RED TAB AND THE COLD LINE TO THE ONE WITH BLUE TAB.

- To mount the panel drill a hole 7mm in the wall and fix the hanging acce

- (11)  ■ Install the handheld shower hook (figure 11)

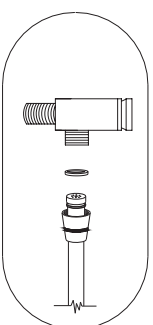
- (12)  ■ Install the shower hose and handheld shower (figure 12... figure 13) PLEASE NOTE THE SHOWER HOSE END WITH A VACUUM BREAKER MUST CONNECT TO THE MALE NIPPLE OF SHOWER HOLDER AND THE SHOWER HOSE END WITHOUT VACUUM BREAKER MUST CONNECT TO THE HAND SHOWER

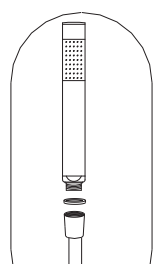
- (13)  ■ Turn on the water at the main then turn on the water and power to the water heater.
- Turn on the shower and allow the water to cycle through then test the temperature to ensure the valve is working properly.

Scale removal & Technical data.

The Spray channels of overhead shower are protected by the self-cleaning system If scale deposits are noticed in the spray channels turn the water on lightly and tub the spray channels with a finger and a sponge

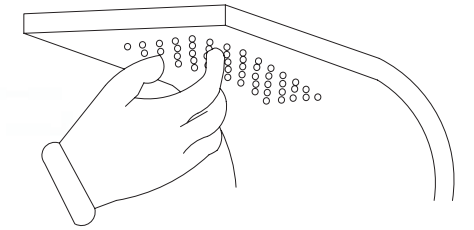

Operating Pressure:	Max 102psi
Recommended pressure:	60-80psi
Max Hot water temperature:	176F
Recommended hot water temperature:	130F-150F
Flow rate 70 psi:	
Hand shower:	2 gpm
Body sprays:	<1 gpm each

Protection against back siphonage is provided by check valves in the hot and cold supply elbows.

Know and follow all applicable local plumbing codes when setting the temperature on the water heater.

4. Overhead shower & 4 massage jets:

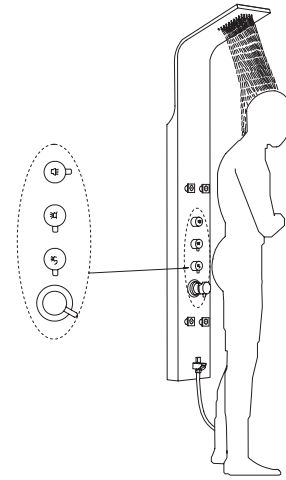

5. Overhead shower & handheld shower:

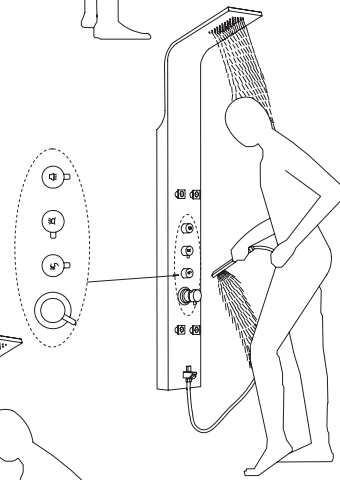

6. Handheld jets & 4 massage shower:

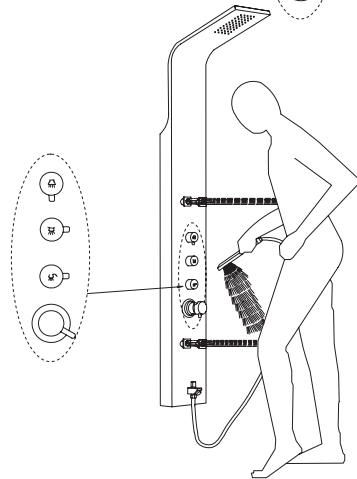

7. Overhead shower, 4 massage jets & handheld shower:

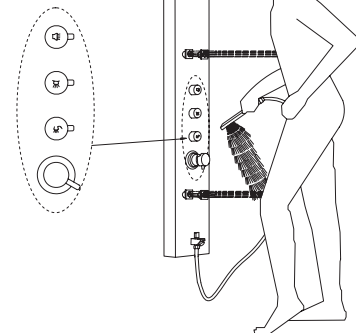

8. Spout

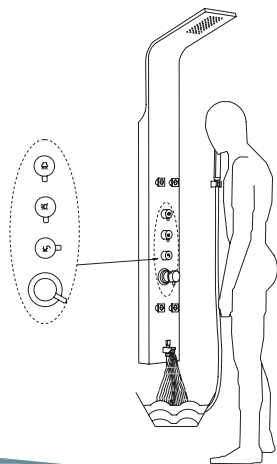

SYMPTOMS	CAUSES	SOLUTIONS
1. No warm water, either cold or hot water only	<p>A. Check the water supply to see if the hot & cold water supply is normal or not.</p> <p>B. Check if the hot line is connected to the control valve end with RED tab or not.</p> <p>C. Disconnect the water supply to control valve and check if the white backflow filters is trapped or in wrong position.</p> <p>D. If a shut-up valve is installed in the water supply, make sure both valve are open in the same position (i.e, both half open or both fully open)</p>	<p>A. If the water supply is not normal in the house, then check with water supply.</p> <p>B. If the hot and cold water supply lines are not correctly connected to the right end, then change them.</p> <p>C. Disconnect the water supply at the valve and put the backflow filter in correct position.</p> <p>D. Check the shut-up valves and make them fully open.</p>
2. Jet water has not enough pressure	<p>A. Water supply has too much or too little pressure.</p> <p>B. The diverter or thermostat valve is malfunctioned. Check if the overhead shower or handheld shower are functioning well or not.</p>	<p>A. Check the water supply and make sure the pressure is 20 psi to 55 psi.</p> <p>B. If one of the functions works well, then the valve might be broken.</p>
3. Some leaks found	<p>A. Some leaks in the water supply line.</p> <p>B. When you use the shower panel you find leaks, while no leaks found when not using it. There should be a leak in the shower panel internal connection. (REMEMBER do not use the teflon tap to connect the control valve and the supply hose, it will cause leaks)</p>	<p>A. If you never use the shower panel and find out there is leaks on the floor or wall, then propably leaks are from the water supply before the control valve. Ask the plumber to check the panel in the back where the leaks is. Tighten the connection or replace the new hose.</p>

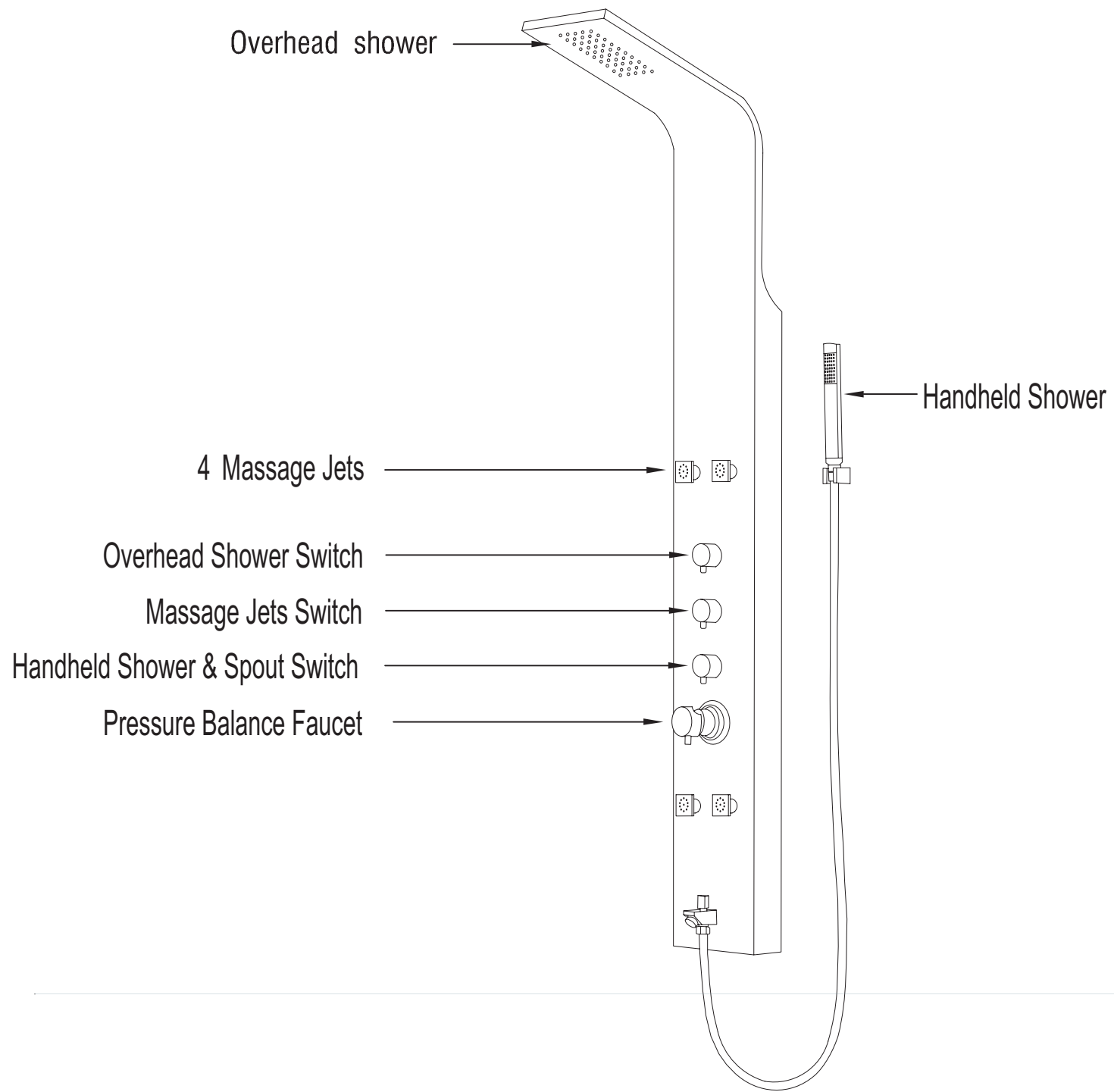

Using the diverter

Turn the handle counter-clockwise to turn the water on. There are 8 functions:

1. Overhead shower

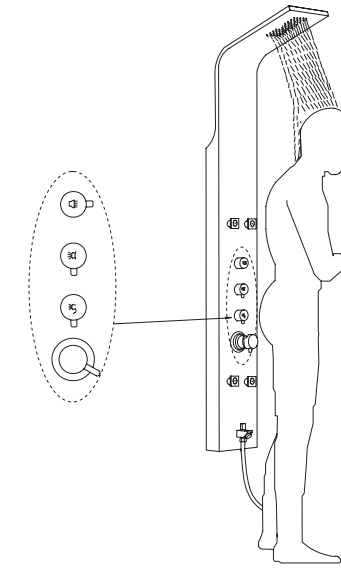

2. Full body massage (all 4 jets spray):

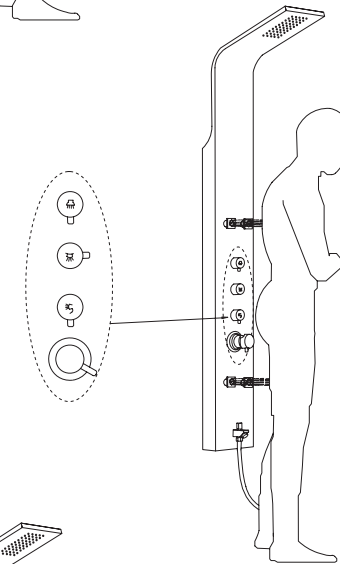

3. Handheld shower

