

Task Office Chair

ASSEMBLY INSTRUCTIONS

Before You Begin:

Please identify all component parts and hardware pieces required before you begin. Carefully remove all of the components from the packaging and set aside for assembly. Assemble on a soft surface to prevent scratching during assembly.

Caution:

Tighten all components securely before use. Failure to do so may result in personal injury. DO NOT use any sharp objects to open plastic wrapped components as damage to product or components may result.

Warning:

CHOKING HAZARD - Small Parts. Adult Assembly Required.

Injury may result from tipping furniture. You must install the Tipping Restraint Hardware with the unit to prevent it from tipping and causing any accidental injury, instability, death or damage. The tipping restraint is intended only as a safety measure, it is not a substitute for proper adult supervision.

This tipping restraint is not an earthquake restraint. If you wish to add the extra security of earthquake restraints, they must be purchased and installed separately.

Serious or fatal crushing injuries can occur from furniture tipping over. To prevent furniture from tipping over it must be permanently fixed to the wall. Fixing devices for the wall are not included since different wall materials require different types of fixing devices. Use fixing devices suitable for the walls in your home.

Failure to detach this restraint before moving furniture may result in injury or damage.

DO NOT ALLOW CHILDREN TO CLIMB ON FURNITURE



Congratulations!

You just purchased a piece of happiness. At Ubique Group, we believe you can transform your spaces into the most inspired places with furnishings that are the perfect combination of form, function and style. As original innovators of online furniture retail, we offer the best selection of popular, contemporary styles at cool, comfortable prices. And, with decades of proven shipping and packaging expertise, our Extended Quality Checklist ensures a rewarding, hassle-free experience time and time again. It's just what you need to bring your vision to life.

Thank you & Enjoy!!
your friends at Ubique Group



LIKE IT!

*Share it on social
& Tell a friend!
#Spaces2Places*



LOVE IT!

*Write an online
product review
where purchased*



NOT SURE?

*Let us help!
Contact our
customer support.*

Have a question, concern or simply need a hand? Your satisfaction is our top priority. Contact us at 866-552-2810 or customerexperience@theubiquegroup.com. We're here to help!

Browse Our Branded Collections

There's something for everyone inside our family of brands.



Visit www.theubiquegroup.com/brands or scan this code.



We pride ourselves on providing an excellent customer experience starting right here with your package and instructions. Everything you need should be right where you need it, so you can get to enjoying your new item ASAP. But despite our best efforts, sometimes "slips happen." If you need any support, from replacement parts to recommendations, please reach out to our wonderful customer support team at 866-552-2810 or customerexperience@theubiquegroup.com. We're here to help!

EVERY UBIQUE GROUP PRODUCT



Quality &
Durability Tested



Packaged
with Care



Shipped from
our U.S. Facility

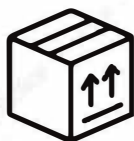

Designed
for Easy
Assembly



















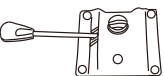

Ethically
Sourced

Please visit <https://www.theubiquegroup.com/warranty> for complete warranty information.

Read this manual before using this product. Failure to follow the instructions and safety precautions in this manual can result in serious injury or death. Keep this manual in a safe location for future reference.

PARTS

A	 Casters	5	F	 Seat	1
B	 Base	1	G	 Arms	2
C	 Gas Lift Cylinder	1	H	 Back & Seat Connector	1
D	 Cylinder Cover	1	I	 Backrest	1
E	 Control Mechanism	1	J	 M7*110MM	1
			K	 M5*10MM	1
			L	 M6*25MM	3
			M	 M6*18MM	4
			N	 M6*18*1MM	1
			O	 M6*14*1MM	8
			P	 M6*30MM	6
			Q	 M4	1
			R	 M5	1



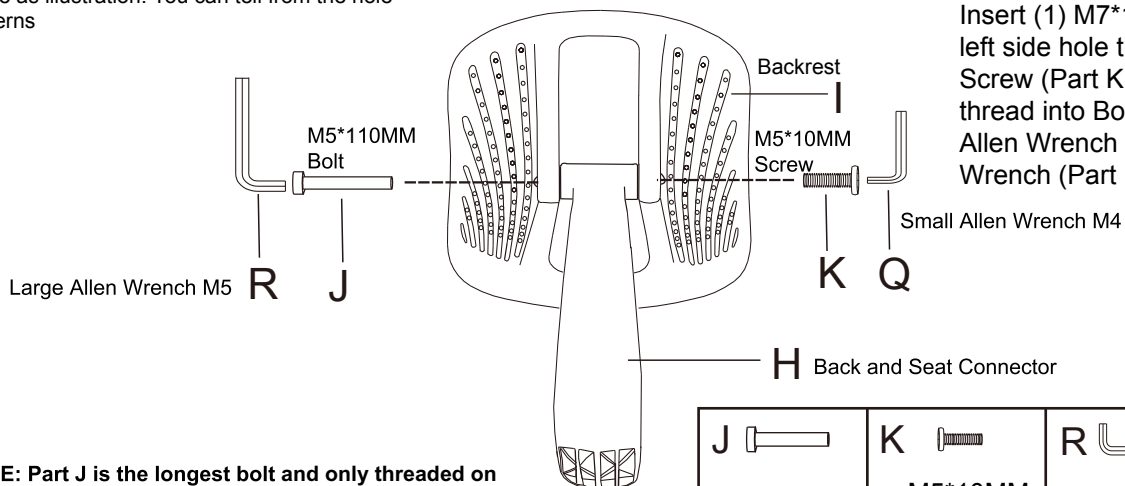

STEP 1

Make sure the orientation of the back is exactly the same as illustration. You can tell from the hole patterns

Align Back and Seat Connector (Part H) with the holes on the Backrest (Part I). Insert (1) M7*110MM Bolt (Part J) into the left side hole then insert (1) M5*10MM Screw (Part K) into the right side hole and thread into Bolt J. Tighten using the Small Allen Wrench (Part Q) and Large Allen Wrench (Part R).



NOTE: Part J is the longest bolt and only threaded on the inside.



J		K		R		Q	
	M7*110MM x1		M5*10MM x1		M5 x1		M4 x1

NOTE: K is the shortest screw.

STEP 2

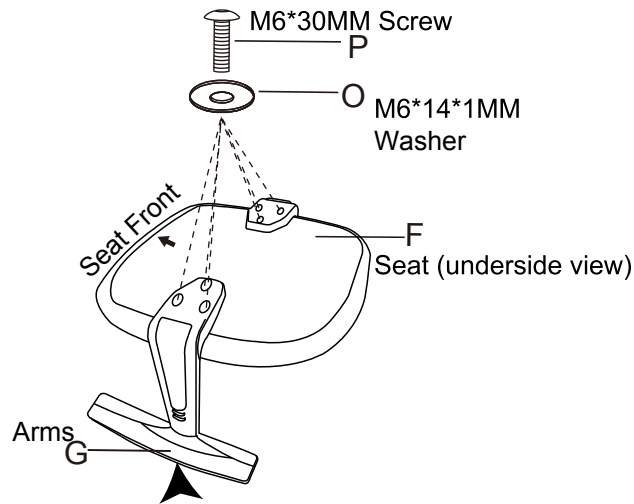
Attach Left and Right Arms (Part G) to underside of Seat (Part F) using (6) M6*14 Washers (Part O) and (6) M6*30MM Screws (Part P). Tighten using Large Allen Wrench (Part R).



P		M6*30MM x6
O		M6*14*1MM x6
R		M5 x1



NOTE: For safety ensure washers are used.

Note: Make sure the armrest is in the correct direction, overhang should face outwards.

STEP 3

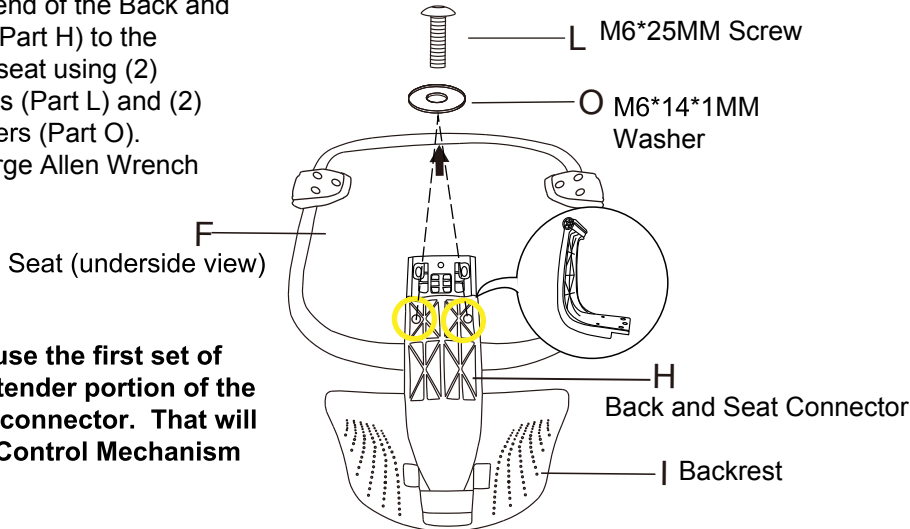
Attach the other end of the Back and Seat Connector (Part H) to the underside of the seat using (2) M6*25MM Screws (Part L) and (2) M6*14MM Washers (Part O). Tighten using Large Allen Wrench (Part R).



L		M6*25MM x2
O		M6*14*1MM x2
R		M5 x1



NOTE: For safety ensure washers are used.

NOTE: Do not use the first set of holes in the extender portion of the Back and Seat connector. That will insert into the Control Mechanism in Step 4.

STEP 4

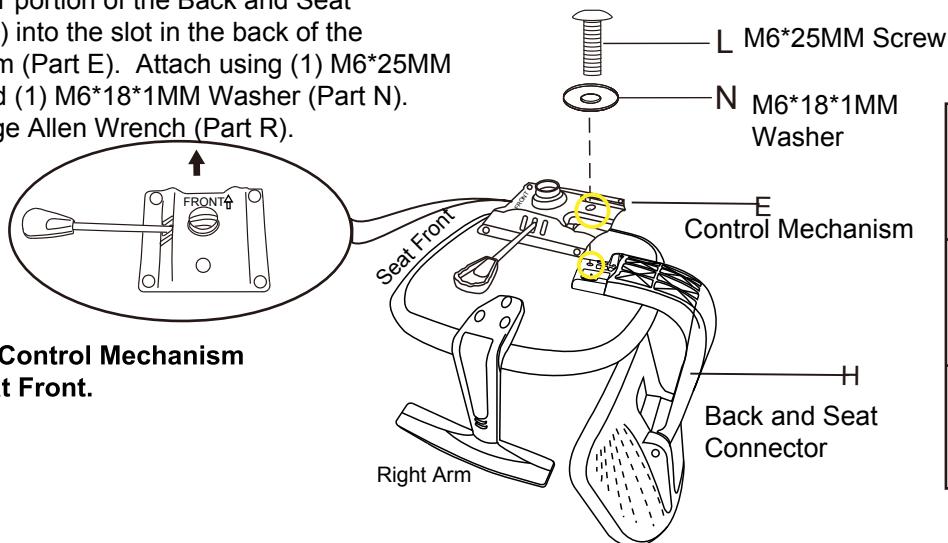
Insert the extender portion of the Back and Seat Connector (Part H) into the slot in the back of the Control Mechanism (Part E). Attach using (1) M6*25MM Screw (Part L) and (1) M6*18*1MM Washer (Part N). Tighten using Large Allen Wrench (Part R).



L		M6*25MM x1
N		M6*18*1MM x1
R		M5 x1

NOTE: For safety ensure washers are used.

NOTE: Front of Control Mechanism should face Seat Front.

STEP 5

Secure Control Mechanism (Part E) to the underside of the Seat (Part F) using (4) M6*18MM Screws (Part M). Tighten using Large Allen Wrench (Part R).

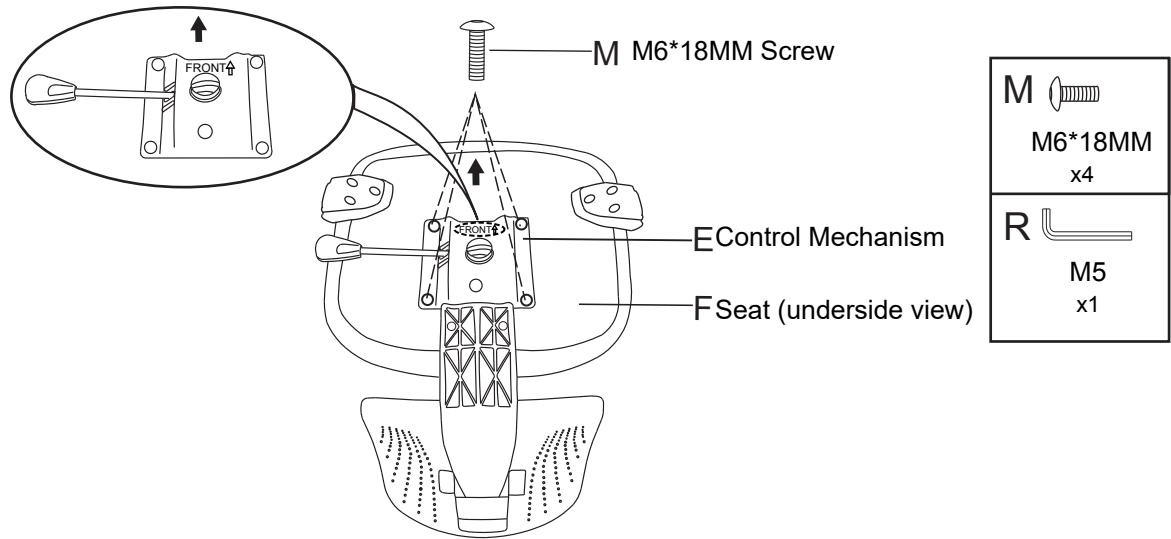

STEP 6

6A: Insert (5) Casters (Part A) into the Base (Part B).

6B: Insert Gas Lift Cylinder (Part C) into Base (Part B) then slide the Cylinder Cover (Part D) over it.

6C: Align the hole in the Control Mechanism (Part E) on the underside of the assembled Seat with the top of the Gas Lift Cylinder (Part C) and push down firmly until fully seated.

