

Please go to www. quozel. com for product cleaning tips. Go to the **Care + Maintenance** selection.

Tools Required: Flathead screwdriver, Phillips screwdriver, pliers, wire cutters, wire strippers, electrical tape, safety glasses.

Light Source: (8) B10 Candelabra Base Bulbs 60W Maximum or

(8) Candelabra Base T8 Vintage Bulbs are recommended but not supplied.

Estimated Assembly Time: 30-45 minutes

Preparation: Identify and inspect all parts before beginning installation. Check package content list and diagrams below to be sure all parts are present. If any parts are missing or damaged, do not attempt to assemble, install, or operate the fixture. Contact customer service for replacement parts.

⚠ Warnings and Cautions

Turn off electricity at circuit breaker or main fuse box before installation. Consult a licensed electrician if in doubt.

These instructions are provided for your safety. It is very important you read them completely before installing the fixture. We strongly recommend that a licensed, professional electrician perform the installation.

Disconnect fixture from power source before replacing bulbs. Make sure bulbs are given sufficient time to cool before removal.

Package Contents

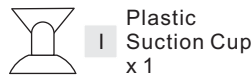
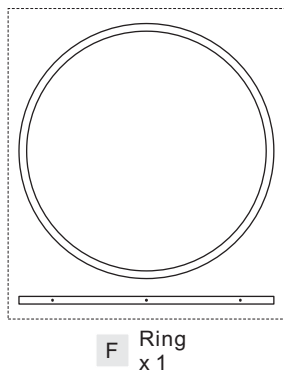
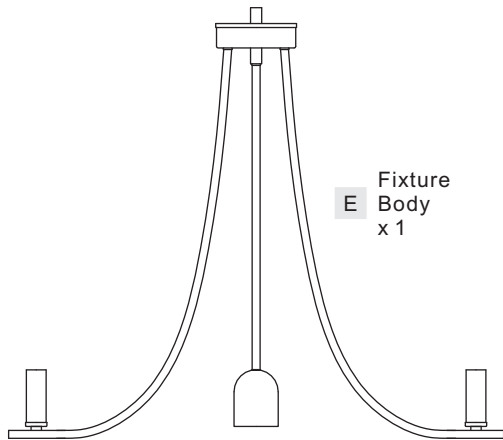
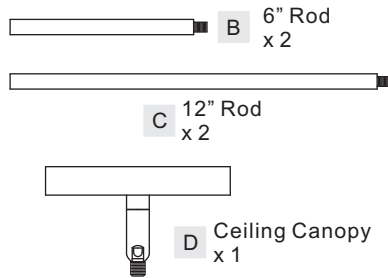
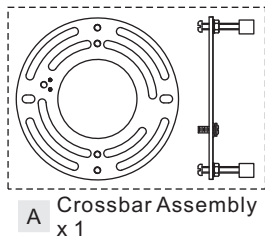

STEP 1 - Install Ring to Fixture Body

A. (Refer to SUPPORT ARM DISTRIBUTION) Unfold support arms of the Fixture Body (E) to proper locations. Attach the Ring (F) to the Fixture Body (E) and align the holes on the Ring (F) to the ends of support arms. Secure by threading Lock Screws (G) into the ends of support arms. Hand tighten until snug.

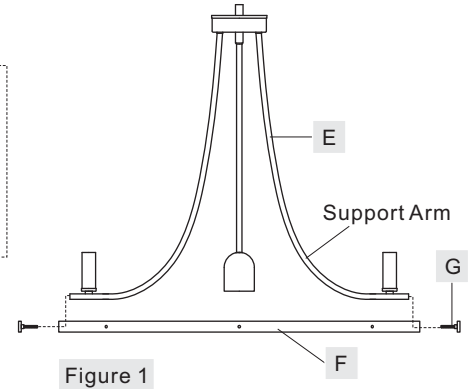
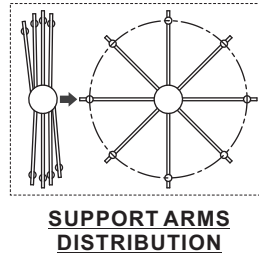

STEP 2 - Install Ceiling Canopy, Rods and Fixture Body together

A. Determine the Rods (B/C) to be assembled to the Fixture Body (E) according to your hanging height.

B. Pass the supply wires and ground wire through the chosen rods (B/C) and the Ceiling Canopy (D). Thread the Fixture Body (E), the chosen Rods (B/C) and the Ceiling Canopy (D) together. Hand tighten until snug.

Suggested rods for Ceiling height :

- 8' ceiling : use (1) 12" rod
- 9' ceiling : use (2) 12" rods
- 10' ceiling : use (2) 6" rods and (2) 12" rods

Figure 2

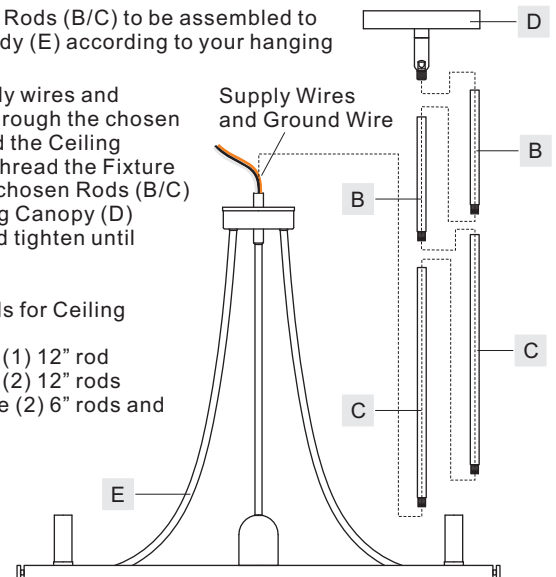

Thank you for purchasing a Quozel product.
Need assistance with parts or assembly? Call Quozel customer service at 1-800-645-3184 or visit us on-line at www. quozel. com

STEP 3 - Installing the Crossbar Assembly

A. Pass the supply wires from outlet box through the Crossbar Assembly (A). Attach the Crossbar Assembly (A) to the Outlet Box with the head of the Green Ground Screw facing you. Secure the Crossbar Assembly (A) with Outlet Box Screws (not included). Tighten until snug.

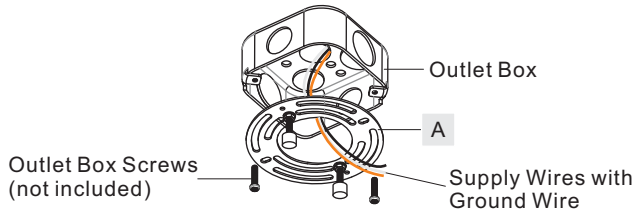

Figure 3

STEP 4 - Test Fitting Ceiling Canopy to Crossbar Assembly

A. Remove mounting balls from the Crossbar Assembly (A). Fit the ceiling canopy and Fixture Body (D) to the Crossbar Assembly (A) and secure with mounting balls. Note: The ceiling canopy should be snug against the ceiling and the mounting balls. If not, adjust the length of the nipple on the Crossbar Assembly (A) by unscrewing the preassembled hex nut and lock washer and then screwing the mounting screws in or out of the crossbar until the correct length is achieved. Once the ceiling canopy and Fixture Body (D) is secure, remove the mounting ball and ceiling canopy and Fixture Body (D) and proceed to Step 5.

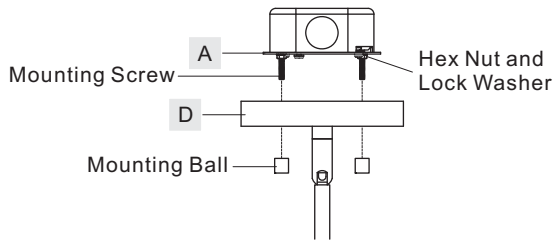

Figure 4

STEP 5 - Wire Connections

A. Use standard wire connectors (not included) to make all wire connections. Twist connectors until wires are tightly joined together. Wrap each connection with approved electrical tape and carefully stuff all the connected wires into the Outlet Box.

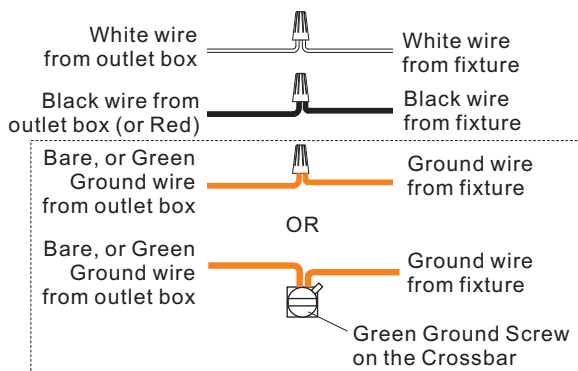

Figure 5

STEP 6 - Install the Fixture

A. Carefully tuck all wires into the outlet box and position the Ceiling Canopy (D) over the outlet box. Align the holes in the ceiling canopy with the mounting screws, then attach the Ceiling Canopy (D) using the previously removed mounting balls. Hand tighten until snug.

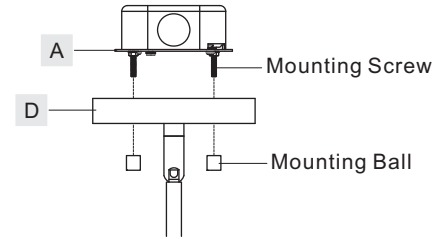

Figure 6

STEP 7 - Install Bulbs

A. Attach the Plastic Suction Cup (I) to the MR16 Lamp (H) and insert the MR16 Lamp (H) onto the socket in the center of the Fixture Body (E). Rotate the MR16 Lamp (H) until it is engaged by the socket.
 B. Remove the Plastic Suction Cup (I) from MR16 Lamp (H).
 C. Insert bulbs onto sockets on the support arms and screw snugly into place.

Your fixture is now assembled and ready to use. Enjoy!

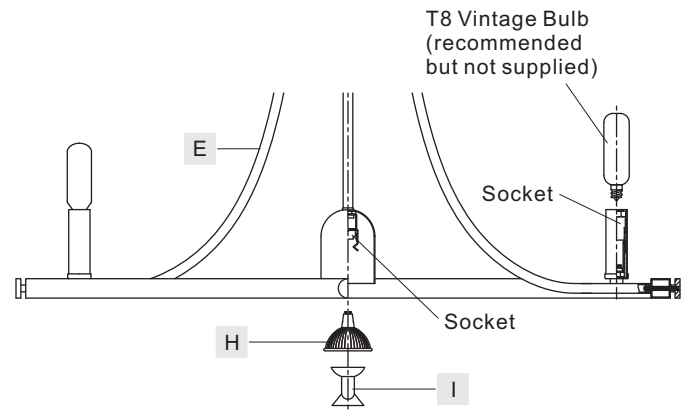
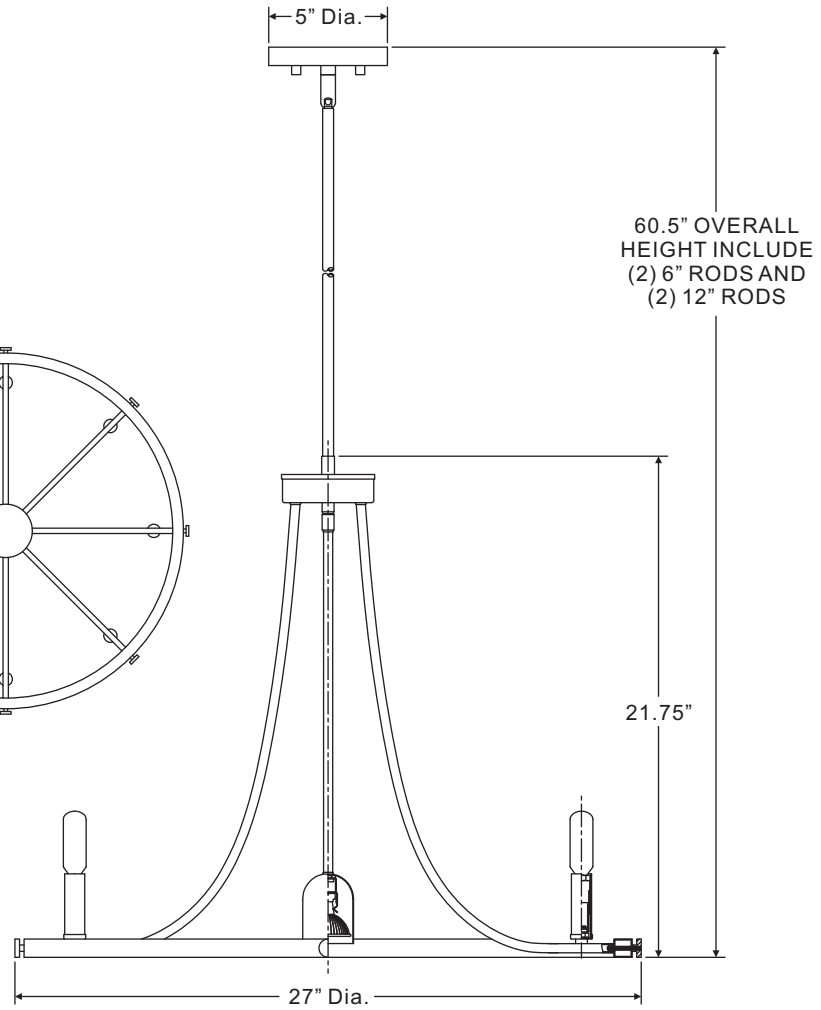
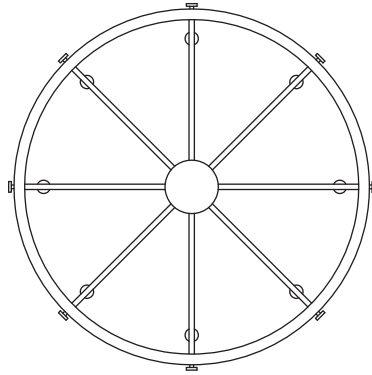
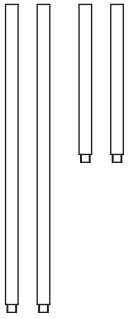
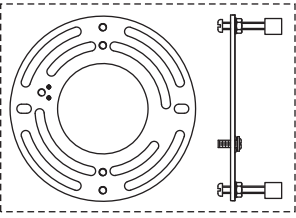

Figure 7

Thank you for purchasing a Quoizel product.
 Need assistance with parts or assembly? Call Quoizel customer service at 1-800-645-3184
 or visit us on-line at www.quoise.com

BLD5008DC

FINISH: DARK CHERRY



NOTE: ALL DIMENSIONS ARE ROUNDED UP TO THE NEAREST 1/4"

Thank you for purchasing a Quozel product.
Need assistance with parts or assembly? Call Quozel customer service at 1-800-645-3184
or visit us on-line at www.quozel.com