

Assembly Instructions

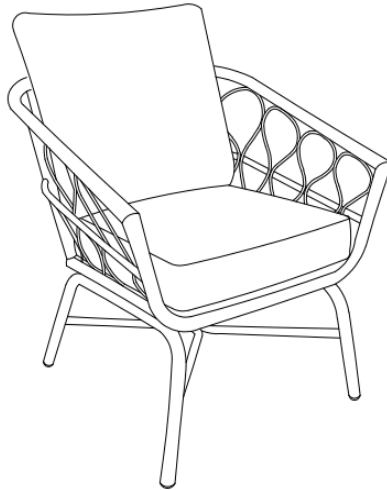



Caution : You must read this before you proceed

Sets often ship in multiple boxes and may arrive a day or two apart.

Chair

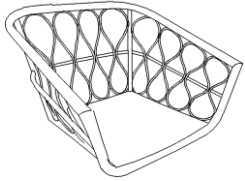

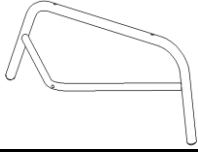
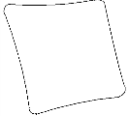
Part List

Label	Picture	Description	QTY
A		Seat	1
B		Left Leg	1
C		Right Leg	1
D		Back Cushion	1
E		Seat Cushion	1

Hardware

Label	Picture	Description	QTY
①		Bolt (M6*40mm)	5
②		Bolt (M6*30mm)	2
③		Washer	6
④		Allen Wrench	1

Assembly Preparation

Before Beginning Assembly:

- Read instructions, cover to cover-
- Have 2 adults on hand for assembly-
- Do not assemble on flooring or carpet-
- Assemble on a clean non-marring surface (packing foam)-
- Save all packaging until finished-

Assembly Steps

Overview

This Chair has multiple parts and may require up to 30 minutes to assemble. To give you an overview of the Chair parts, the above picture is to help you put the various parts into perspective. Please read through the instructions below to familiarise yourself with the parts and steps before assembly.

Assembly Steps

Step 1

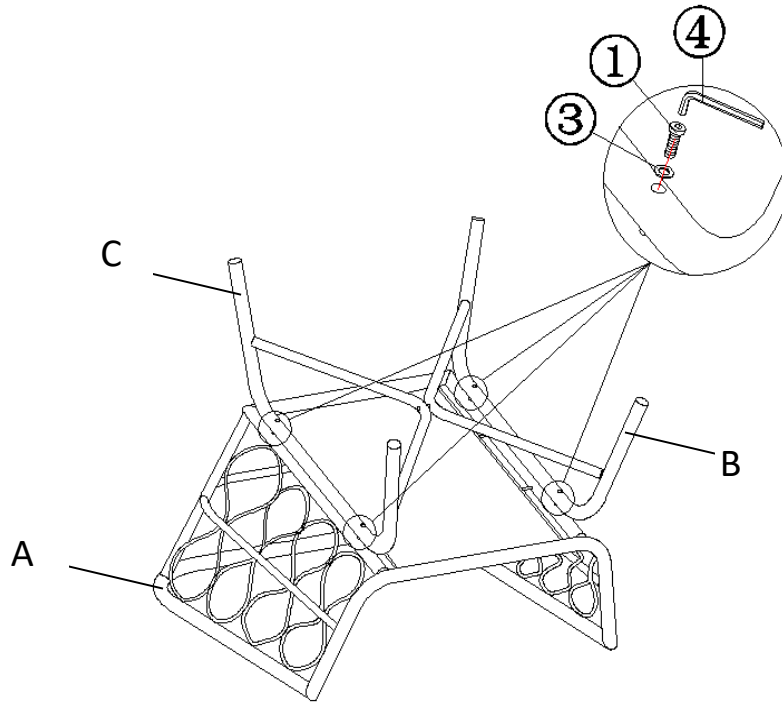

Open the carton and place all the parts onto a clean, non-marring surface.

Attach the Left Leg (B) and the Right Leg (C) to the Seat (A) using the Bolts(①) and Washers(③) with the Allen Wrench (④).

Do not fully tighten all the Bolts.

Note: Occasionally some of the PE wickers will cover the Bolt points, preventing easy assembly, the PE wicker should not be cut but moved away from the mounting positions.

Step 2

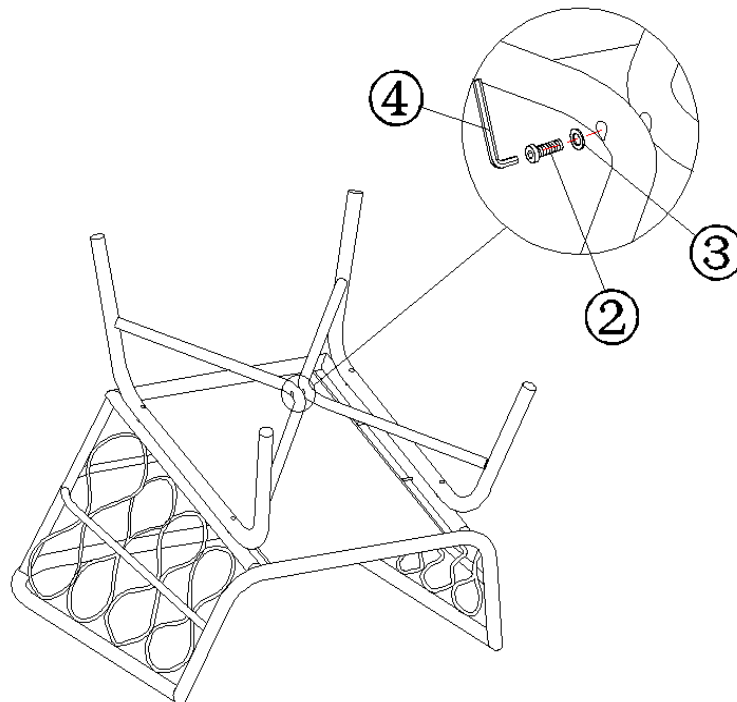

Attach the Left Leg (B) and Right Leg (C) using the Bolts(②) and Washers(③) with the Allen Wrench(④).

Tighten all the Bolts.

Step 4

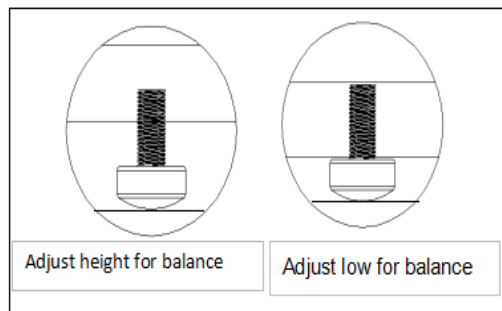
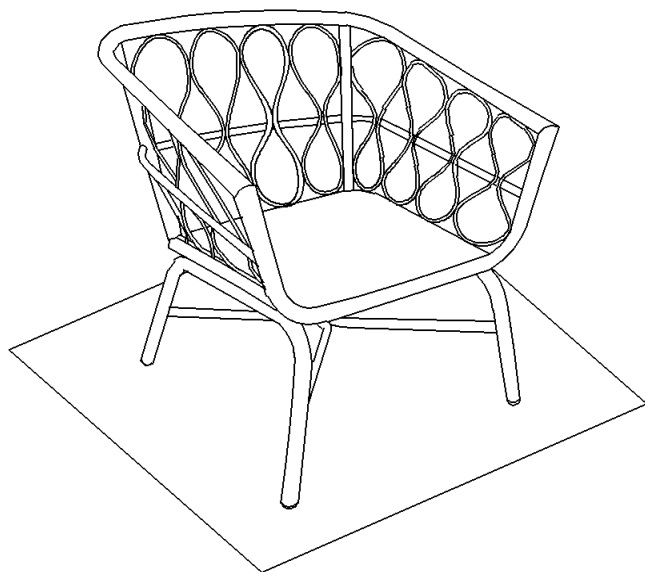

Place the Chair on a **LEVEL SURFACE** to check for wobbles.
If it wobbles, adjust the Foot Screws at the bottom of the Legs to achieve levelness.



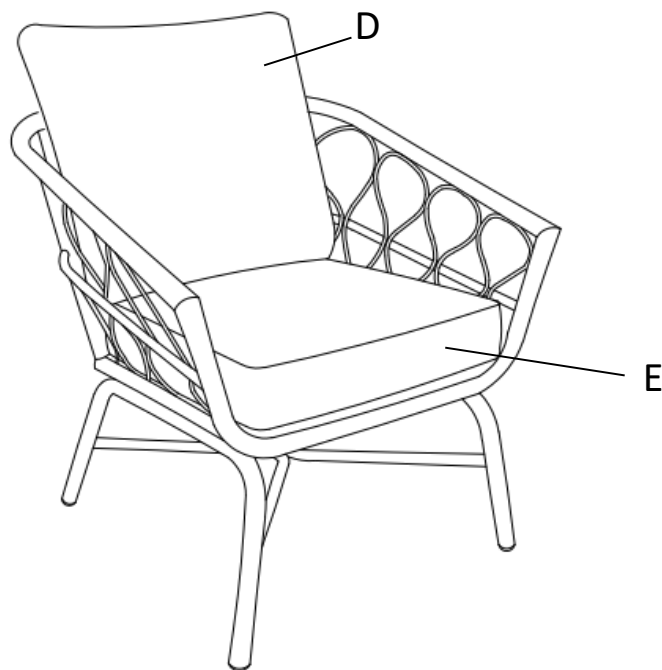







Step 3



Place the Seat Cushion(E) and the Back Cushion(D) on the Chair.
Your Chair is ready for use.

This Chair can only be used on a flat, level surface.

Care & Maintenance

- ⊘  ● Prolonged exposure to rain may cause rusting which can stain floors.
- ⊘  ● Do not put hot items directly on furniture surface.
- ⊘  ● Do not clean furniture with harsh cleansers or polish.
- ✓  ● To obtain the longest lifespan of your outdoor products, minimizing exposure to direct sunlight is recommended.
- ⊘  ● Children should not climb or jump on the furniture.
- ⊘  ● Do not write on furniture without a padded barrier to protect the surface.
- ✓  ● To obtain the longest lifespan of your outdoor products, avoid extended and lengthy exposure to rain, snow, and direct sunshine. Whenever possible cover the product and /or place under patio or awnings.
- ⊘  ● Not for commercial use. For residential use only.
- ⊘  ● Stains may be removed with mild soap solution and damp cloth.
- ✓  ● Keep away from sources of ignition.
- ✓  ● Dust and pick-up spills using a clean, non-colored, lint-free cloth.