



ITEM #6034648

MODEL #TGZ90370

# SOFT-TOP GAZEBO

Español p. 15

STYLE SELECTIONS and logo design are trademarks or registered trademarks of LF, LLC. All rights reserved.

**ATTACH YOUR RECEIPT HERE**

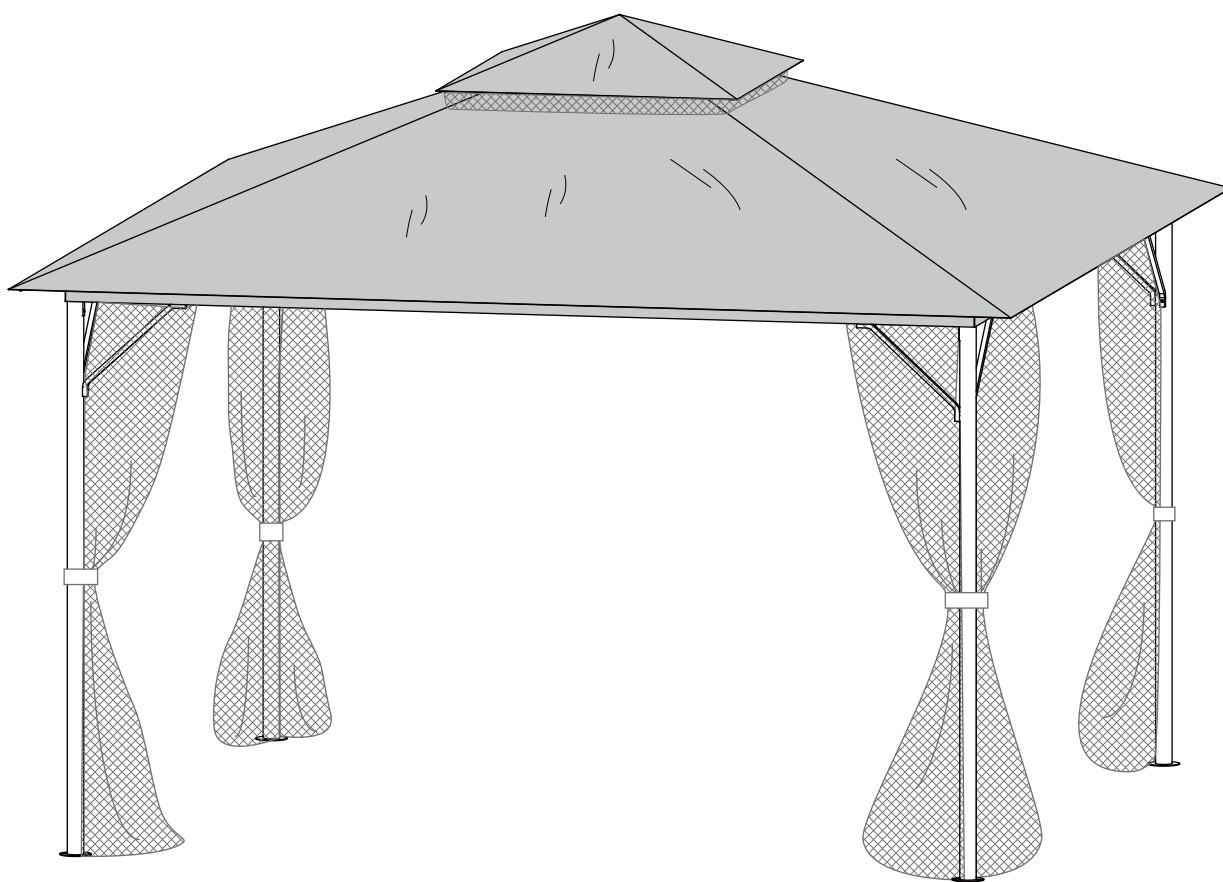

**Serial Number** \_\_\_\_\_

**Purchase Date** \_\_\_\_\_

Thank you for purchasing this STYLE SELECTIONS product.  
Questions, problems or missing parts?  
Before returning, contact us on:  
**877-888-8225**, 8 a.m. - 8 p.m., EST, Monday - Sunday or [ascs@lowes.com](mailto:ascs@lowes.com).

## TABLE OF CONTENTS

---

Package Contents .....	3
Hardware Contents .....	4
Safety Information .....	5
Preparation .....	5
Installation Instructions.....	6
Care and Maintenance .....	14
Warranty .....	14
Replacement Parts List .....	14

# PACKAGE CONTENTS

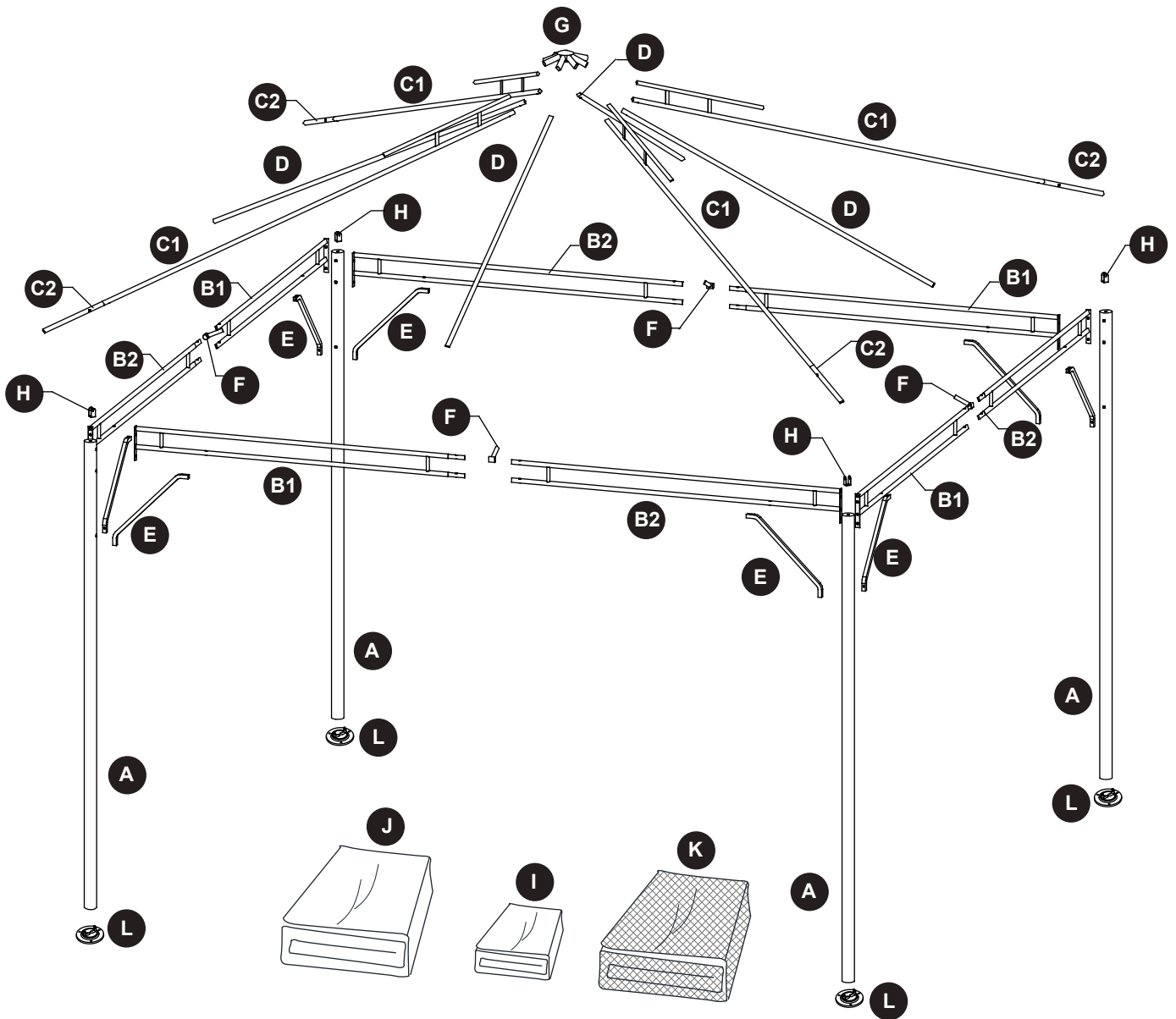

PART	DESCRIPTION	QUANTITY
A	Post	4
B1	Lintel	4
B2	Lintel	4
C1	Roof Support	4
C2	Roof Support	4
D	Roof Support	4
E	Slant Brace	8

PART	DESCRIPTION	QUANTITY
F	Connector	4
G	Center Device	1
H	Connector	4
I	Small Canopy	1
J	Big Canopy	1
K	Mosquito Nets	4
L	Base Plate	4

# HARDWARE CONTENTS (NOT TO SCALE)

AA

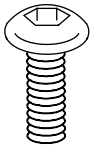

M6 x 15 mm Bolt  
Qty. 4 + 1 Extra

BB

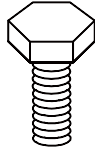

M6 x 15 mm Bolt  
Qty. 24+2 Extra

CC

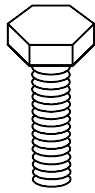

M6 x 27 mm Bolt  
Qty. 16+1 Extra

DD

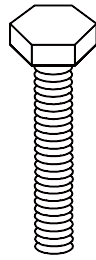

M6 x 42 mm Bolt  
Qty. 8 + 1 Extra

EE



Washer  
Qty. 76 + 2Extra

FF

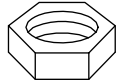

Nut  
Qty. 20 + 2 Extra

GG

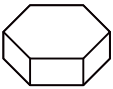

Bolt Cover  
Qty. 52 + 2 Extra

HH

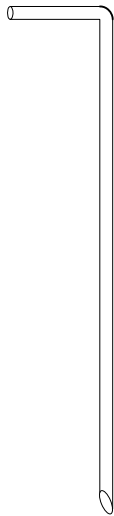

Stake  
Qty. 8

II

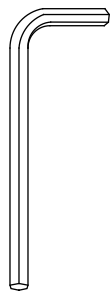

Wrench  
Qty. 1

JJ

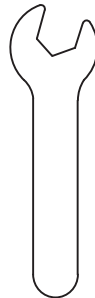

Wrench  
Qty. 2

KK

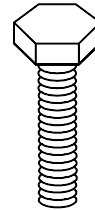

M6 x 32 mm Bolt  
Qty. 4 + 1 Extra

## SAFETY INFORMATION

---

Please read and understand this entire manual before attempting to assemble, operate or install the product.

### WARNING

- **WARNING: KEEP ALL FLAME AND HEAT SOURCES AWAY FROM THIS TENT FABRIC.** The fabric may burn if left in continuous contact with any flame source. The application of any foreign substance to the tent fabric may render the flame-resistant properties ineffective.
- If high winds, heavy rains or any snow occurs, remove roof and curtain, and check for damage before continued use.

### CAUTION

#### SET UP YOUR GAZEBO PROPERLY

- 3 people are recommended for safe assembly.
- Keep all children, pets and other obstructions away from assembly area.
- If any part is missing or damaged, do not attempt to assemble the product.
- In order to avoid damage to the gazebo and its components please use appropriate tools.
- Do not use the structure as support.
- Check all bolts on a regular basis to maintain the solidity of the structure.
- Keep instructions for future use.
- Do not climb on top of the gazebo. Falling off the gazebo can result in serious injury, possibly even death.

#### EXAMINE YOUR GAZEBO

- Examine occasionally to ensure there are no loose parts.  
If loose parts are found, they should be retightened immediately.

### PREPARATION

---

Before beginning assembly of product, make sure all parts are present. Compare parts with package contents list and hardware contents list. If any part is missing or damaged, do not attempt to assemble the product.

#### Estimated Assembly Time: 40 minutes

Tools Required for Assembly (not included): Safety goggles, Gloves, Hard hat, Stepladder.



Safety goggles



Gloves







Hard hat

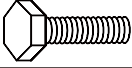
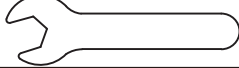

Stepladder

# INSTALLATION INSTRUCTIONS

## 1 Hardware Used



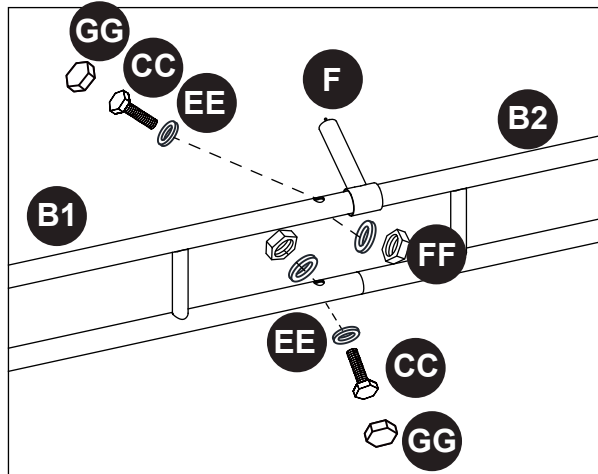
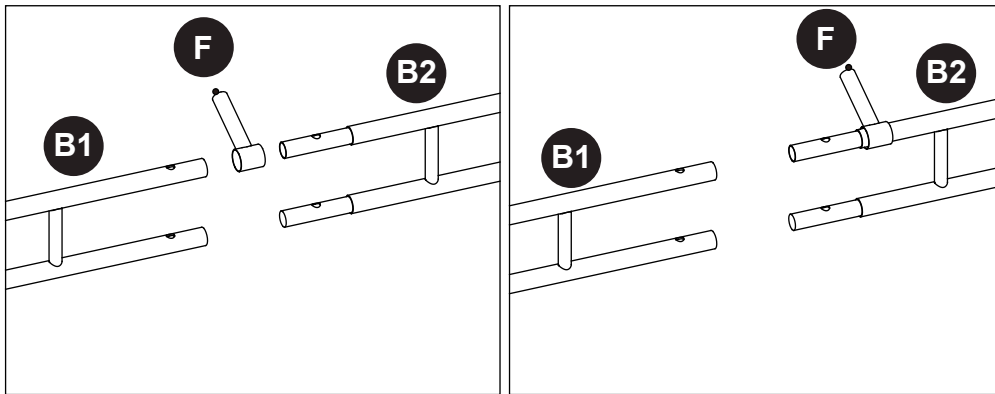
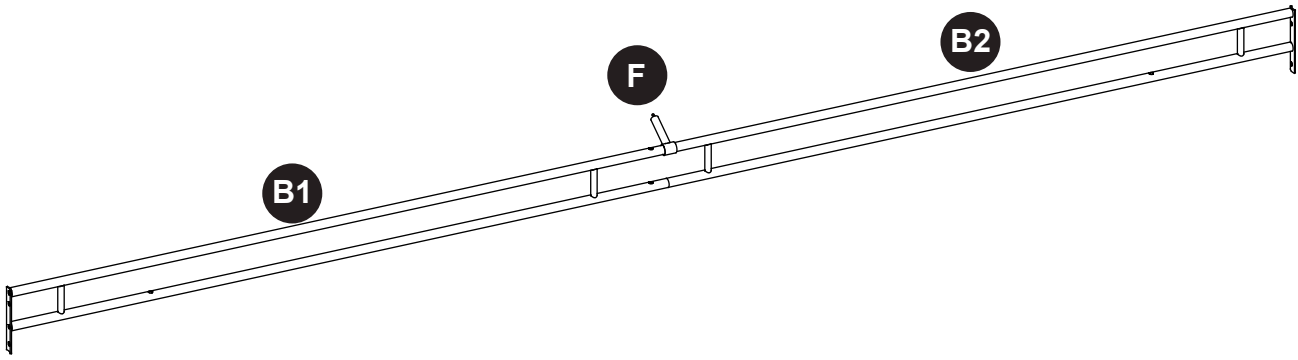

<b>CC</b>		x8	<b>JJ</b>		x2
<b>EE</b>		x16	<b>GG</b>		x8
<b>FF</b>		x8			

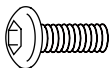

1. Connect the lintel (B1/B2) with the connector (F) together, fix with the bolt (CC), flat washer (EE) and nut (FF). Tighten together with the wrench (JJ). Place bolt cover (GG) on the bolt (CC).

# INSTALLATION INSTRUCTIONS

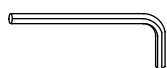
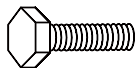
## 2 Hardware Used

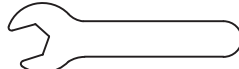
AA		x4	EE		x12
II		x1	BB		x8
GG		x8	II		x1

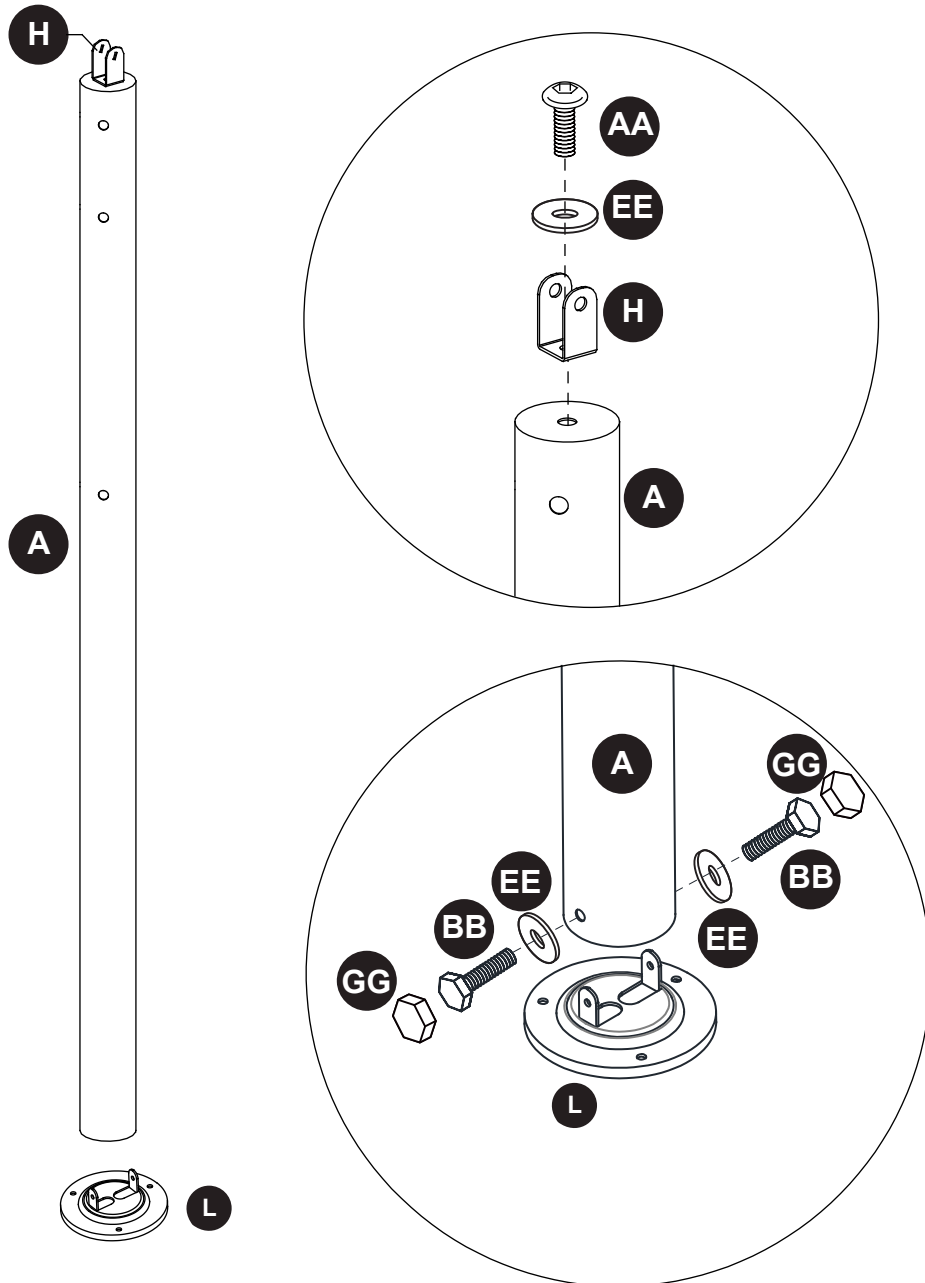





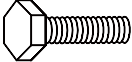

2.1 Connect the connector (H) with the post (A) together, fix with the bolt (AA) and flat washer (EE). Don't tighten together with the wrench (II).

2.2 Attach the base plate (L) to the post (A) with the bolt / washer / cap (BB/EE/GG).

# INSTALLATION INSTRUCTIONS

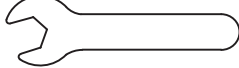
## 3 Hardware Used



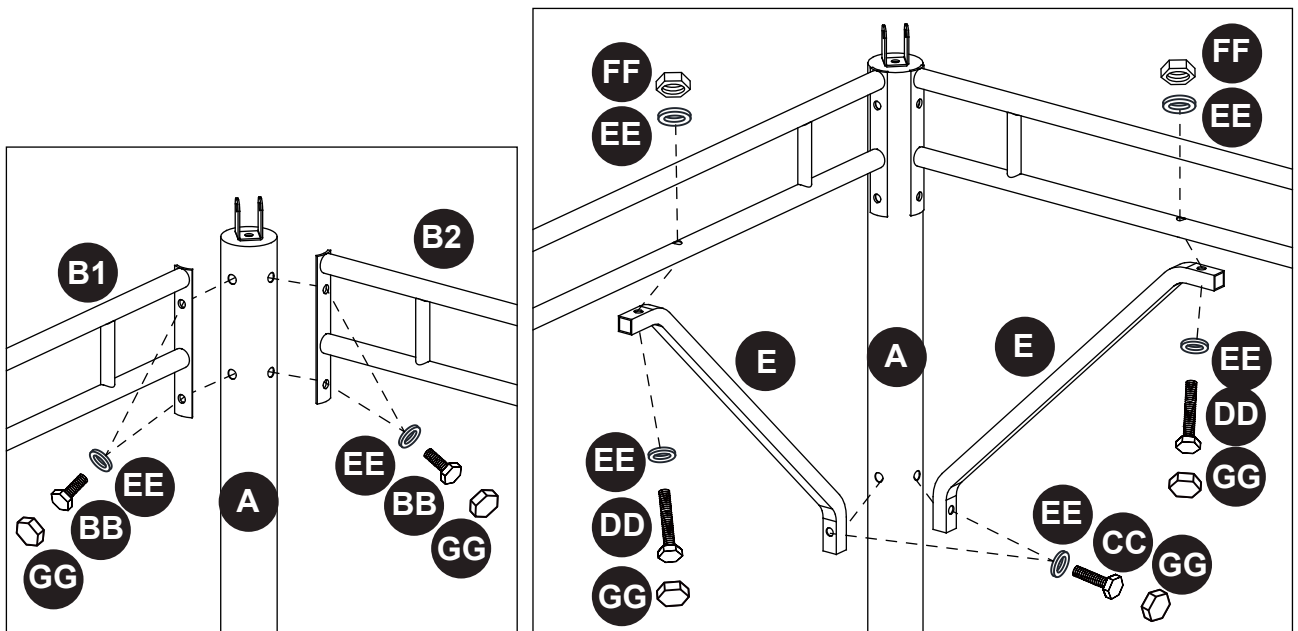
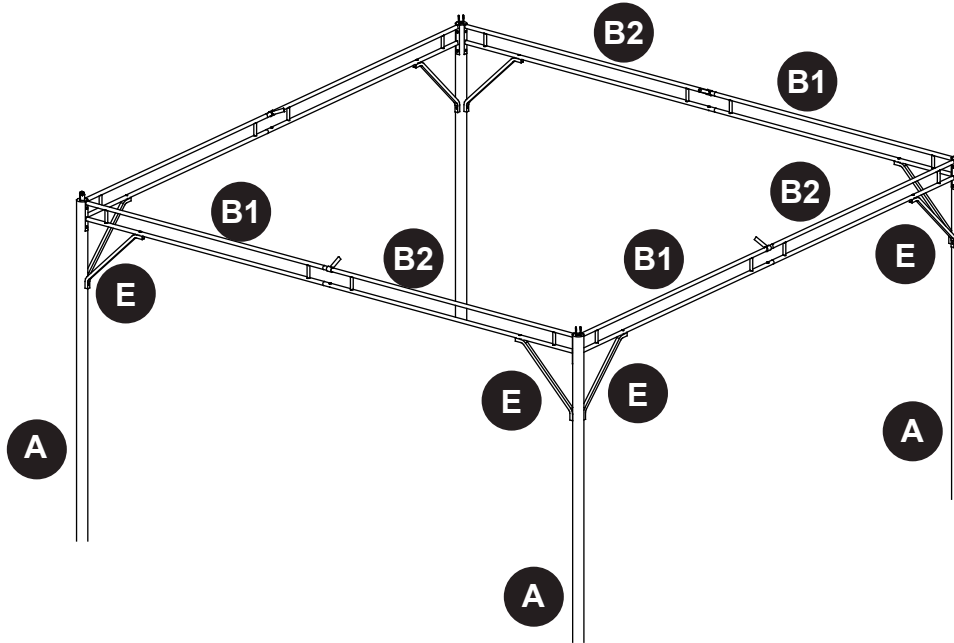

<b>BB</b>		x16	<b>DD</b>		x8
<b>CC</b>		x8	<b>GG</b>		x32
<b>EE</b>		x40	<b>JJ</b>		x2
<b>FF</b>		x8			

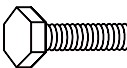
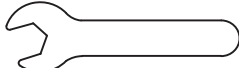

3. Connect the assembled lintels (B1/B2) with the post (A) together, fix with the bolt (BB), flat washer (EE). Then connect the slant brace (E) with the post (A) and the lintels (B1/B2) together, fix with the bolt (CC/DD), flat washer (EE) and nut (FF). Tighten together with the wrench (JJ). Place bolt cover (GG) on the bolt (BB/CC/DD).

# INSTALLATION INSTRUCTIONS

## 4 Hardware Used

<b>KK</b>		x4	<b>JJ</b>		x2
<b>EE</b>		x8	<b>GG</b>		x4
<b>FF</b>		x4			

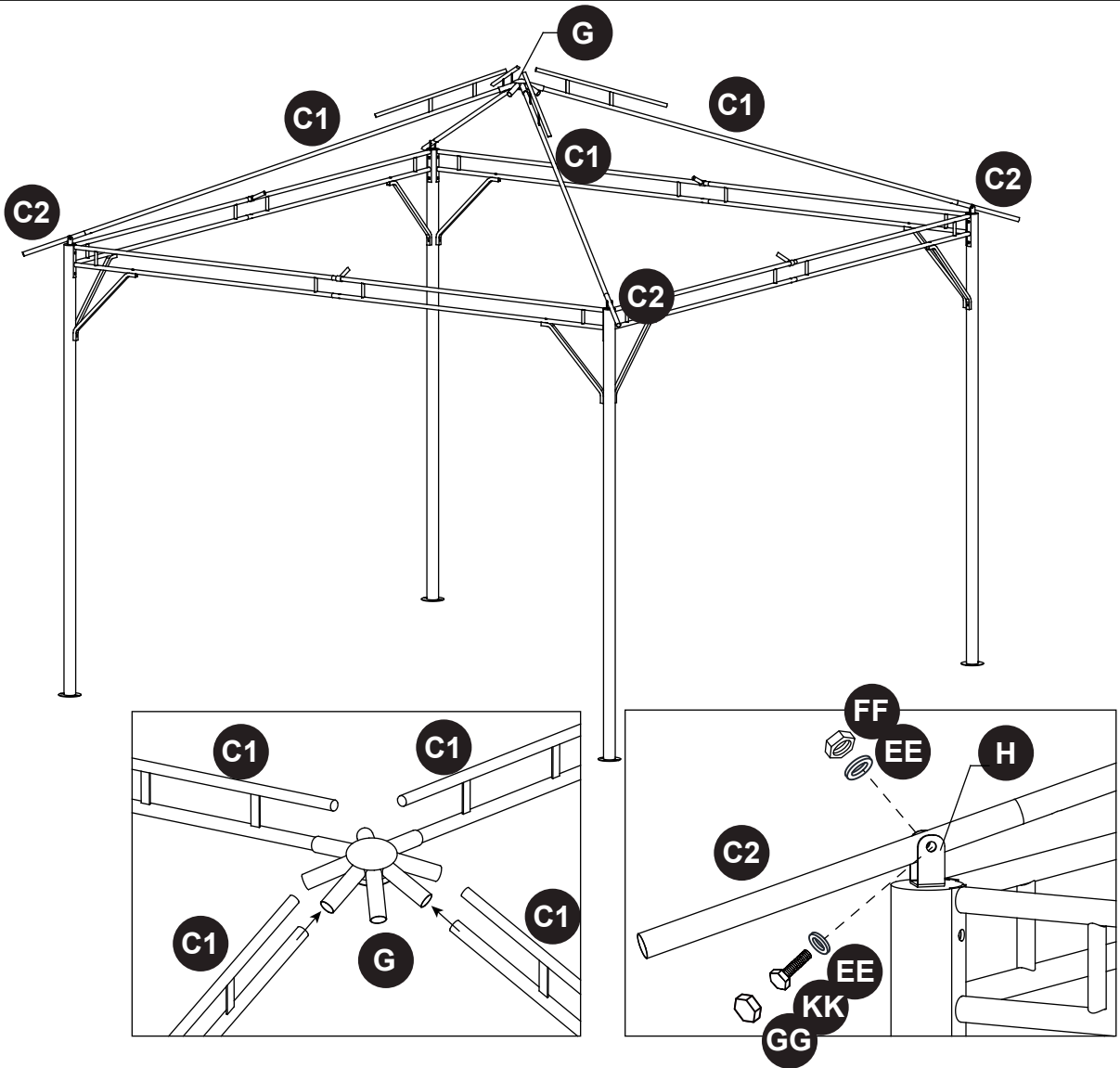
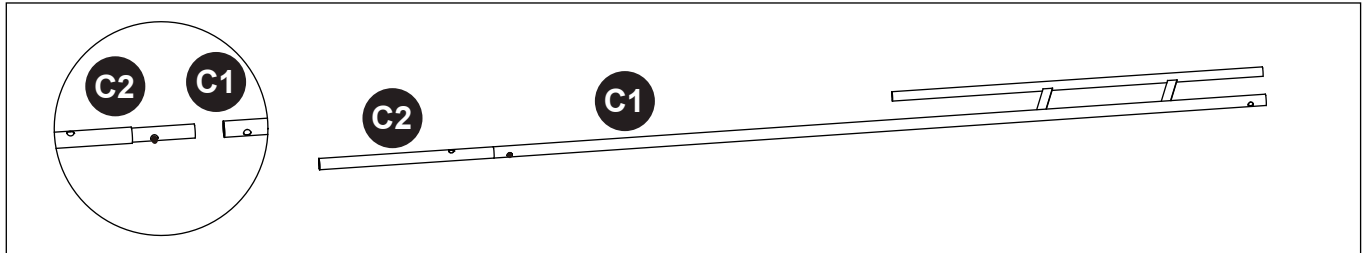

4. Insert the roof support (C2) into the roof support (C1), then insert the roof support (C1) into the center device (G), then connect the roof support (C2) with the connector (H) together, fix with the bolt (KK), flat washer (EE) and nut (FF). Tighten together with the wrench (JJ). Place bolt cover (GG) on the bolt (KK).

# INSTALLATION INSTRUCTIONS

**5**

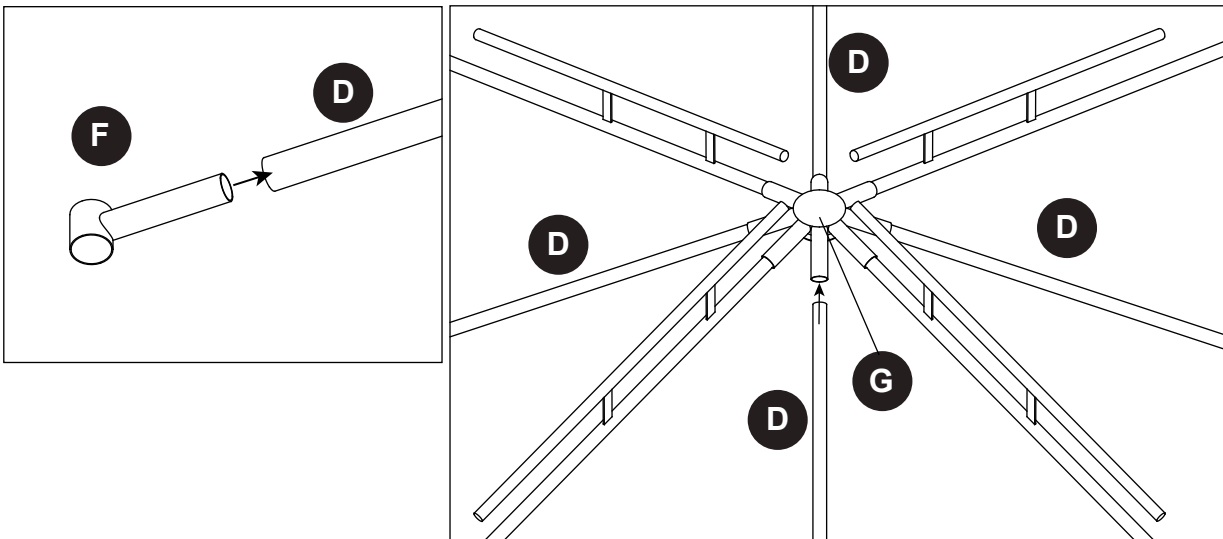
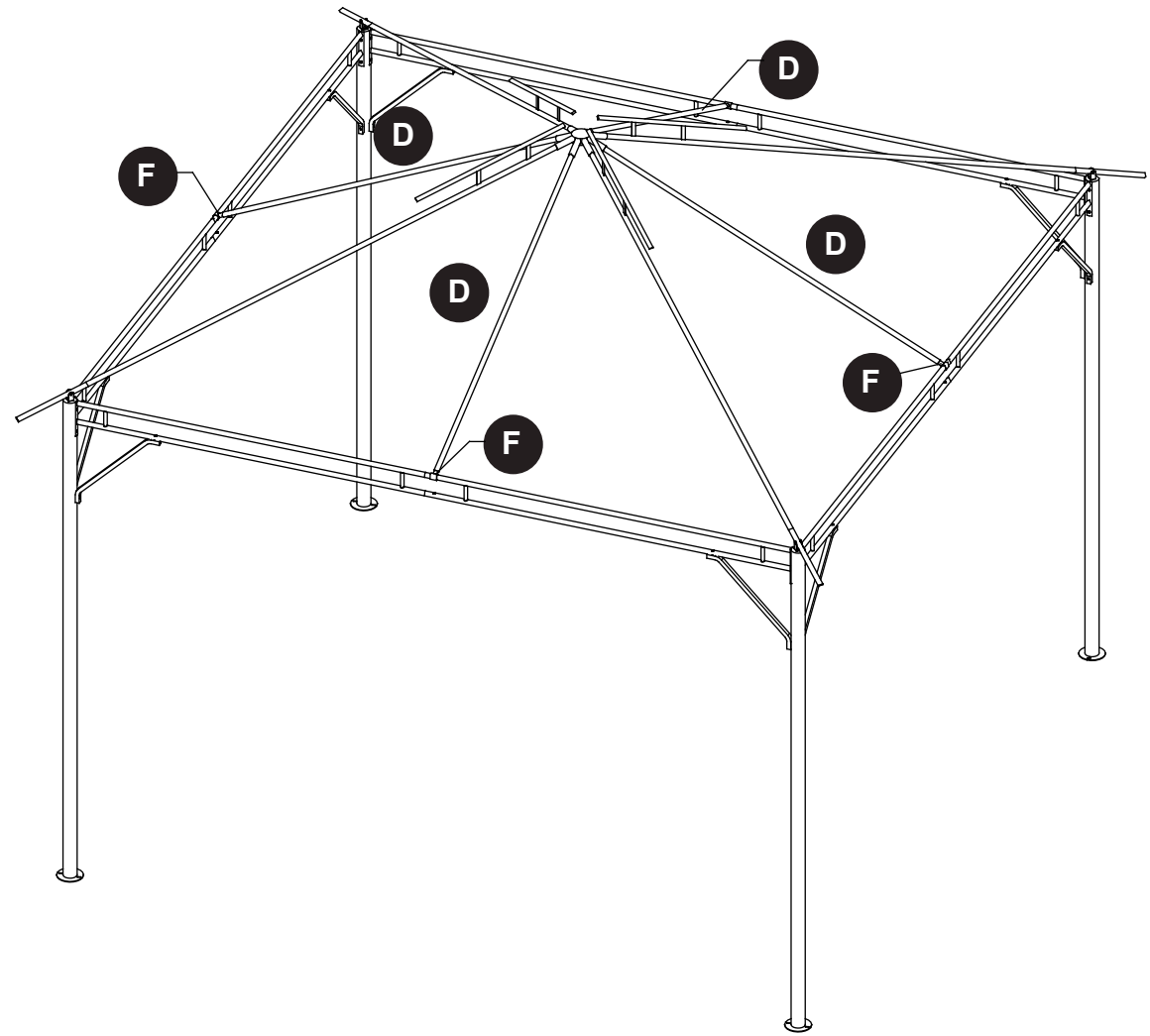

5. Insert the connector (F) into the roof support (D), then insert the roof support (D) into the center device (G).

## INSTALLATION INSTRUCTIONS

6

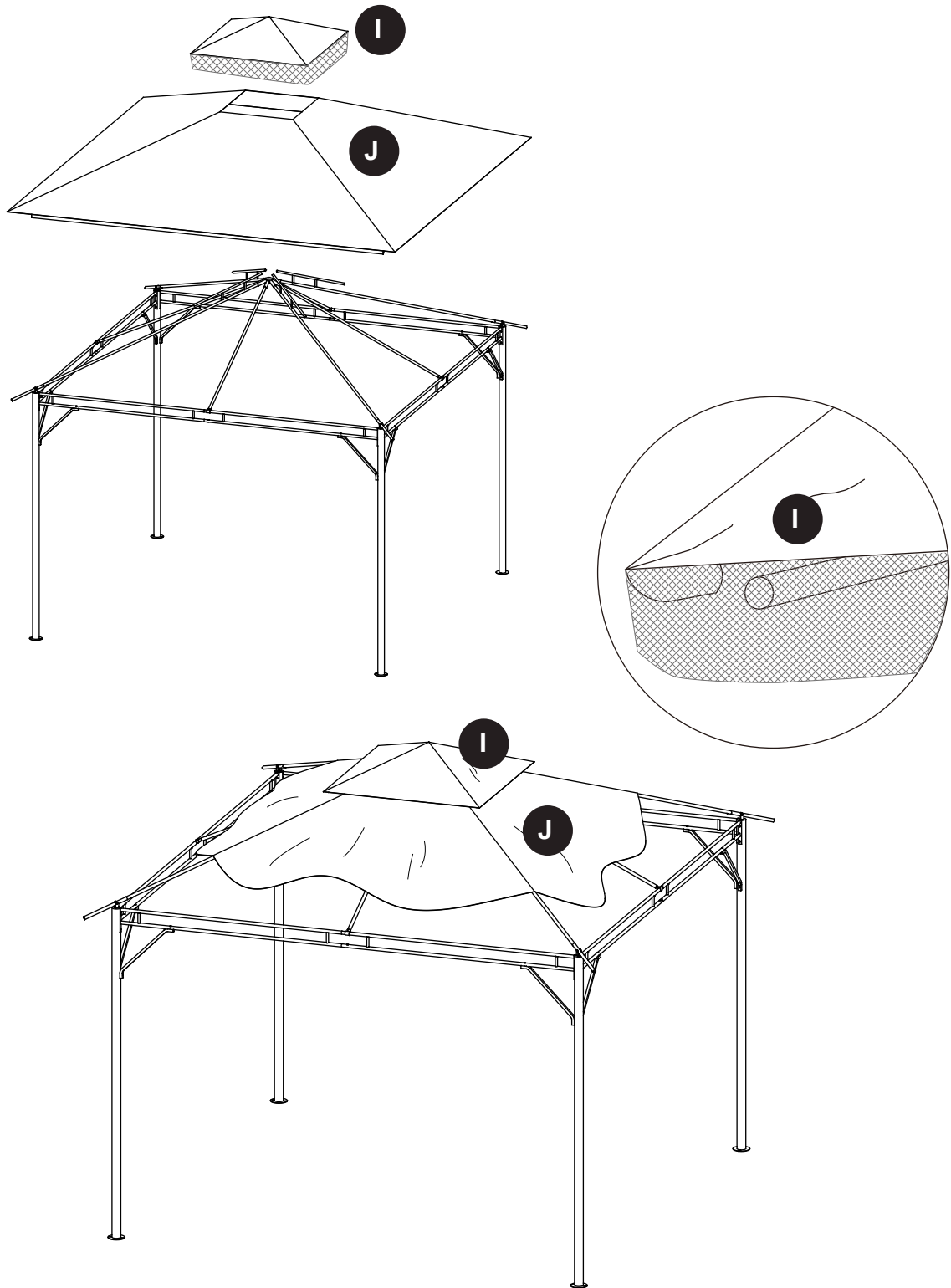

6. Place the big canopy (J) on the lower roof frame. Do not expand the big canopy at this step. Attach small canopy (I) on the top roof frame, then attach the four corners of the small canopy to the upper frame.

7

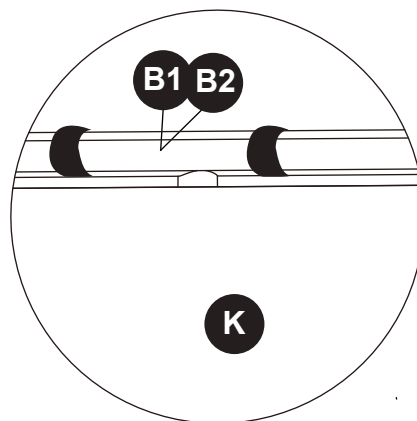
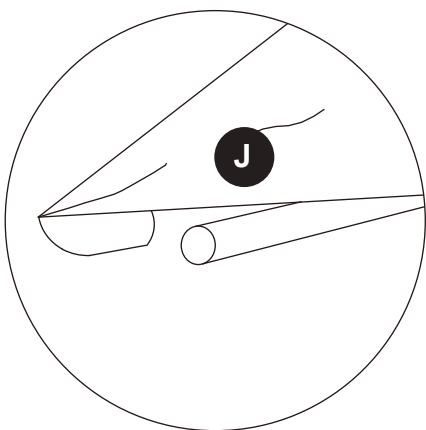
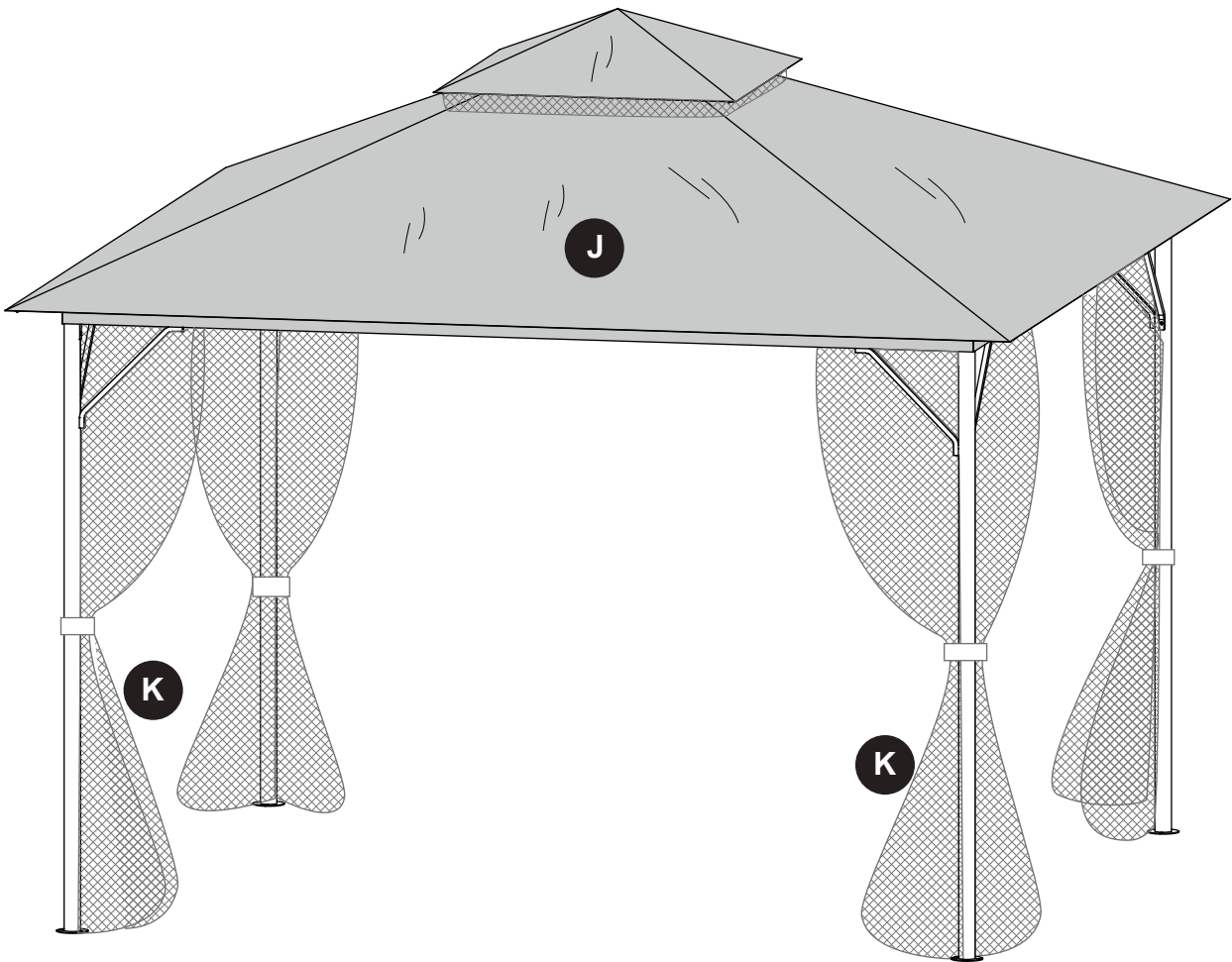

- 7.1 Expand the big canopy (J) on the lower roof frame. Attach the corners of the big canopy to the ends of the lower frames.
- 7.2 Attach the mosquito nets (K) to the lintels (B1/B2).

## INSTALLATION INSTRUCTIONS

### 8 Hardware Used

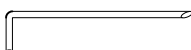
HH		x8
----	---	----

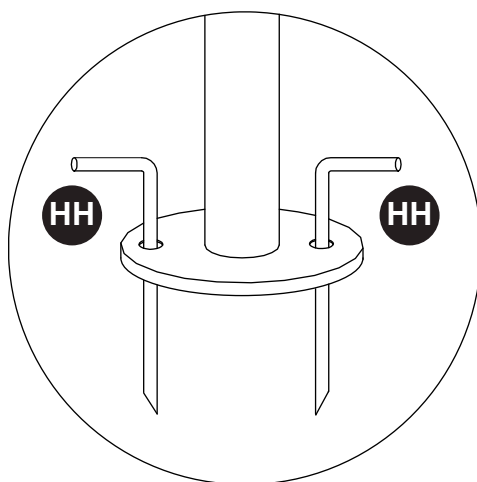
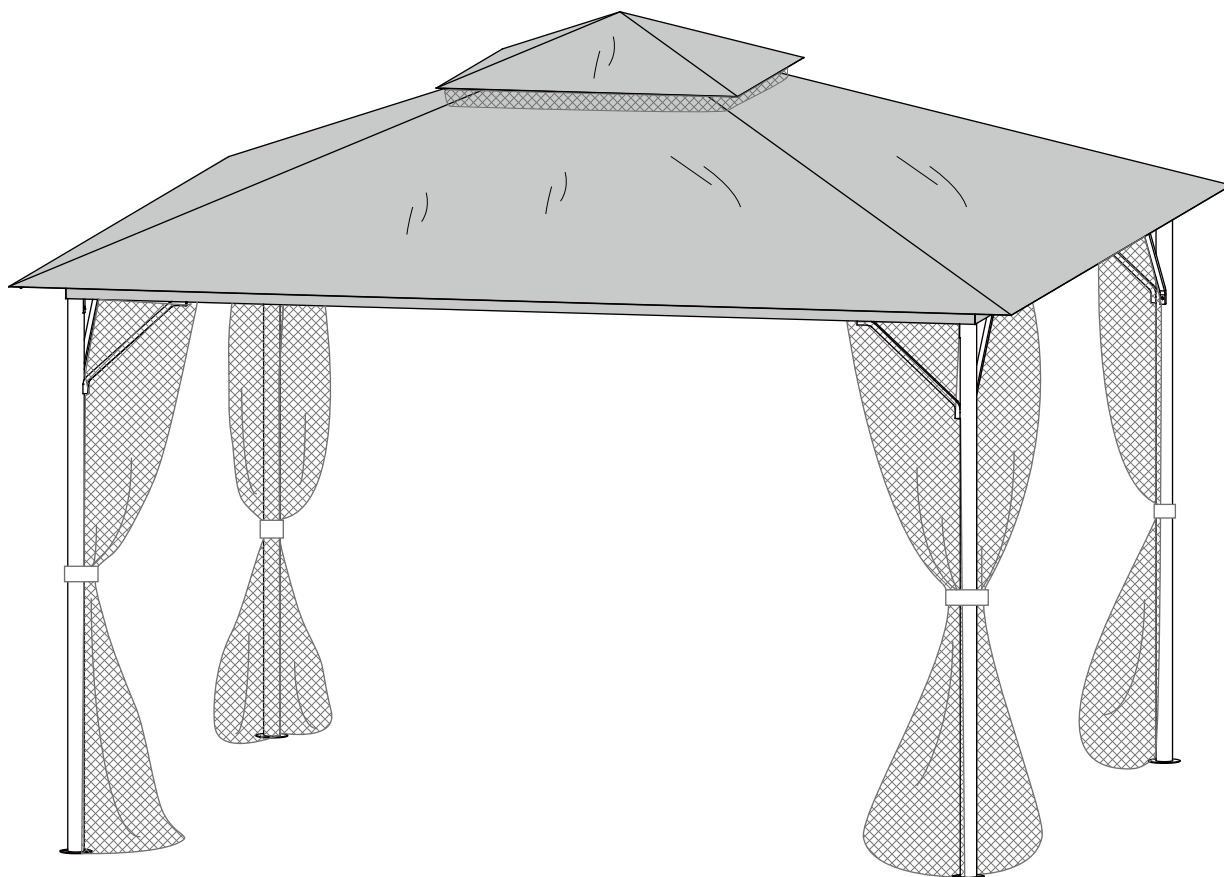

8. Secure the gazebo into the ground using the stakes (HH). Repeat this step for every post until all four posts are anchored.

## CARE AND MAINTENANCE

---

- For cleaning, use a mild detergent solution, rinse with water, and allow to air dry.  
Do not use acetone, abrasive, or other special detergents as they would be harmful to the product's finish.
- Due to the nature of steel, surface oxidation (rusting) will occur if this protective coating is scratched.  
This is a natural process. To minimize this condition, it is recommended that care be taken when assembling and handling the product in order to prevent the paint from being scratched.

## WARRANTY

---

### 1 YEAR WARRANTY FOR FRAME AND FABRIC.

- WHAT IS COVERED

We provide warranty to the original purchase for 1 year for frame and fabric from the date of purchase, and the fabric and frame will be replaced at no charge due to manufacturing defects.

- WHAT IS NOT COVERED

We do not reimburse for transportation costs. This warranty does not cover the damage caused by commercial use, acts of nature, fire, freezing, and abusive use. Discoloration or fading of the finish or fabrics as a result of chemicals or spills is not covered.

Contact the Customer Service Team at **877-888-8225**.

## REPLACEMENT PARTS LIST

---

For replacement parts, call our customer service department at **877-888-8225**, 8 a.m. - 8 p.m., EST, Monday - Sunday. You could also contact us at [ascs@lowes.com](mailto:ascs@lowes.com).

PART	DESCRIPTION	PART #	COVERED UNDER WARRANTY
A	Post	6034648-A	YES
B1	Lintel	6034648-B1	YES
B2	Lintel	6034648-B2	YES
C1	Roof Support	6034648-C1	YES
C2	Roof Support	6034648-C2	YES
D	Roof Support	6034648-D	YES
E	Slant Brace	6034648-E	YES
F	Connector	6034648-F	YES
G	Center Device	6034648-G	YES
H	Connector	6034648-H	YES
I	Small Canopy	6034648-I	YES
J	Big Canopy	6034648-J	YES
K	Mosquito nets	6034648-K	YES
L	Base Plate	6034648-L	YES
AA-KK	Hardware Pack	6034648-AA-KK	YES



ARTÍCULO #6034648

MODELO #TGZ90370

# GAZEBO DE CUBIERTA SUAVE

ADJUNTE SU RECIBO AQUÍ

STYLE SELECTIONS y el diseño del logotipo son marcas comerciales o marcas registradas de LF, LLC. Todos los derechos reservados.

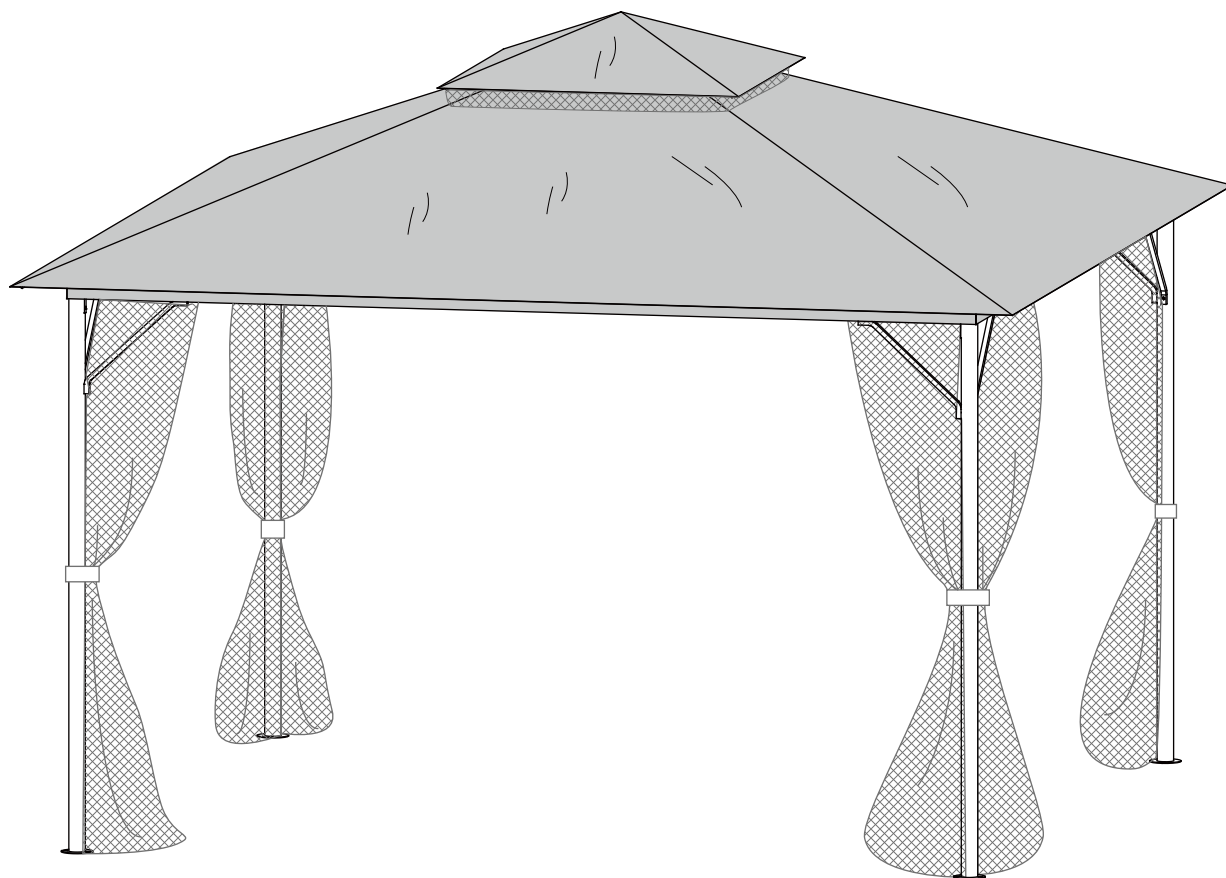

Número de serie \_\_\_\_\_

Fecha de compra \_\_\_\_\_

Gracias por comprar este producto STYLE SELECTIONS.  
¿Preguntas, problemas o piezas faltantes?  
Antes de volver a la tienda, póngase en contacto al:  
**877-888-8225**, de lunes a domingo de lunes a domingo de 8 a.m. a 8 p.m.,  
hora estándar del Este, o a través de [ascs@lowes.com](mailto:ascs@lowes.com).

## ÍNDICE

---

Contenido del paquete.....	17
Aditamentos.....	18
Información de seguridad.....	19
Preparación.....	19
Instrucciones de instalación.....	20
Cuidado y mantenimiento.....	28
Garantía.....	28
Lista de piezas de repuesto .....	28

# CONTENIDO DEL PAQUETE

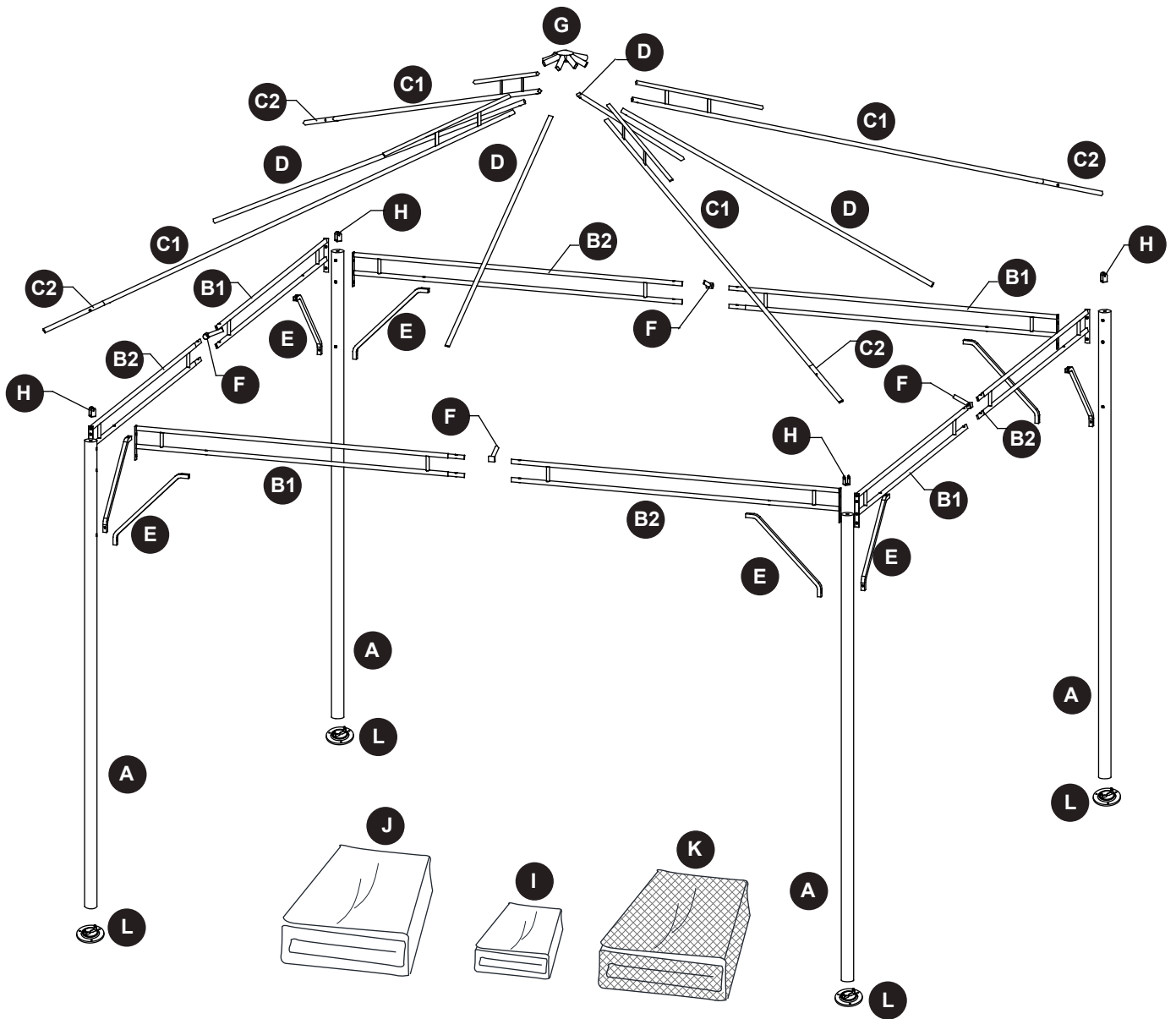

PIEZA	DESCRIPCIÓN	CANTIDAD
A	Poste	4
B1	Dintel	4
B2	Dintel	4
C1	Soporte de techo	4
C2	Soporte de techo	4
D	Soporte de techo	4
E	Soporte inclinado	8

PART	DESCRIPTION	QUANTITY
F	Conector	4
G	Dispositivo central	1
H	Conector	4
I	Cubierta pequeña	1
J	Cubierta grande	1
K	Mosquiteros	4
L	Placa base	4

# ADITAMENTOS (NO SE MUESTRAN A)

AA

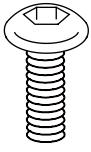

Perno M6 x 15 mm  
Cant.: 4 + 1  
adicional

BB

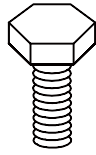

Perno M6 x 15 mm  
Cant.: 24 + 2  
adicionales

CC

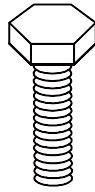

Perno M6 x 27 mm  
Cant.: 16 + 1  
adicional

DD

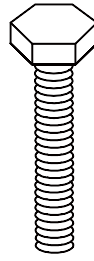

Perno M6 x 42 mm  
Cant.: 8 + 1  
adicional

EE



Arandela  
Cant.: 76 + 2  
adicionales

FF

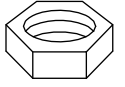

Tuerca  
Cant.: 20 + 2  
adicionales

GG

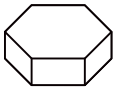

Cubierta para perno  
Cant.: 52 + 2 adicionales

HH

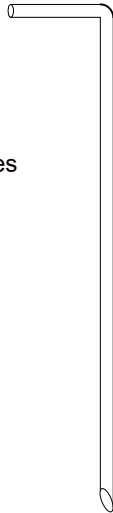

Estacas  
Cant.: 8

II

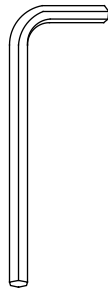

Llave Allen  
Cant. 1

JJ



Llave inglesa  
Cant.: 2

KK

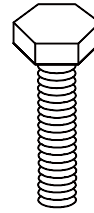

Perno M6 x 32 mm  
Cant.: 4 + 1 adicional

## **! INFORMACIÓN DE SEGURIDAD**

---

Lea y comprenda completamente este manual antes de intentar ensamblar, usar o instalar el producto.

### **ADVERTENCIA**

- **ADVERTENCIA: MANTENGA LA TELA DE LA TIENDA ALEJADA DE LAS LLAMAS Y LAS FUENTES DE CALOR.** La tela podría quemarse si se encuentra en continuo contacto con cualquier fuente de calor. La aplicación de cualquier sustancia extraña a la tela de la tienda puede hacer que sus propiedades ignífugas se anulen.
- En casos de viento fuerte, lluvia torrencial o nieve, retire el techo y la cortina y revise si hay daños antes de continuar usando el producto.

### **PRECAUCIÓN**

#### **ENSAMBLAR EL GAZEBO ADECUADAMENTE**

- Se recomiendan tres personas para un ensamblaje seguro.
- Mantenga a niños, mascotas y otras obstrucciones alejados del área de ensamblaje.
- No intente ensamblar el producto si falta alguna pieza o alguna está dañada.
- Para evitar que se produzcan daños en el gazebo y sus componentes, use las herramientas correspondientes.
- No utilice la estructura como soporte.
- Revise todos los pernos periódicamente para mantener la solidez de la estructura.
- Conserve las instrucciones para usarlas en el futuro.
- No se trepe al gazebo. Las caídas desde el gazebo podrían provocar lesiones graves o incluso la muerte.

#### **EXAMINAR EL GAZEBO**

- De vez en cuando, examine el gazebo para asegurarse de que no haya piezas sueltas. Si encuentra piezas sueltas, ajústelas de inmediato.

## **PREPARACIÓN**

---

Antes de comenzar a ensamblar el producto, asegúrese de tener todas las piezas. Compare las piezas con la lista del contenido del paquete y la lista de aditamentos. No intente ensamblar el producto si falta alguna pieza o alguna está dañada.

### **Tiempo estimado de ensamblaje: 40 minutos**

Herramientas necesarias para el ensamblaje (no se incluyen): gafas de seguridad, guantes, casco, escalera de tijera.



Gafas de seguridad



Guantes







Casco

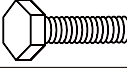
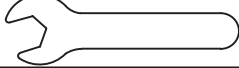

Escalera de tijera

# INSTRUCCIONES DE INSTALACIÓN

## 1 Aditamentos



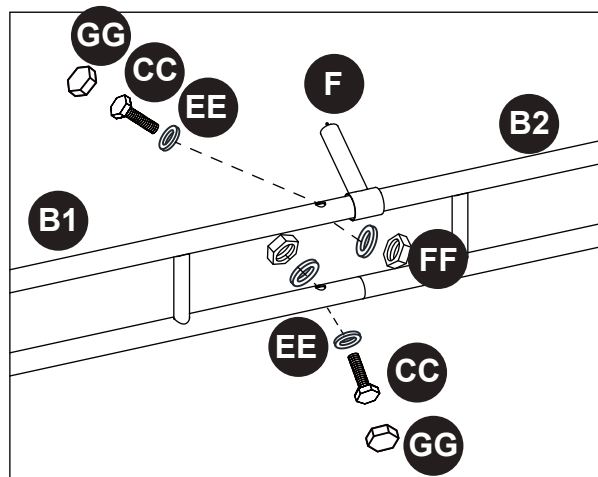
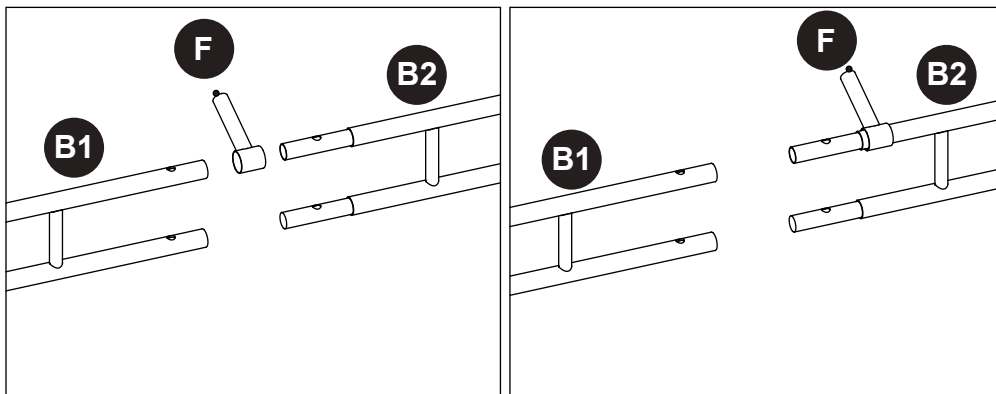
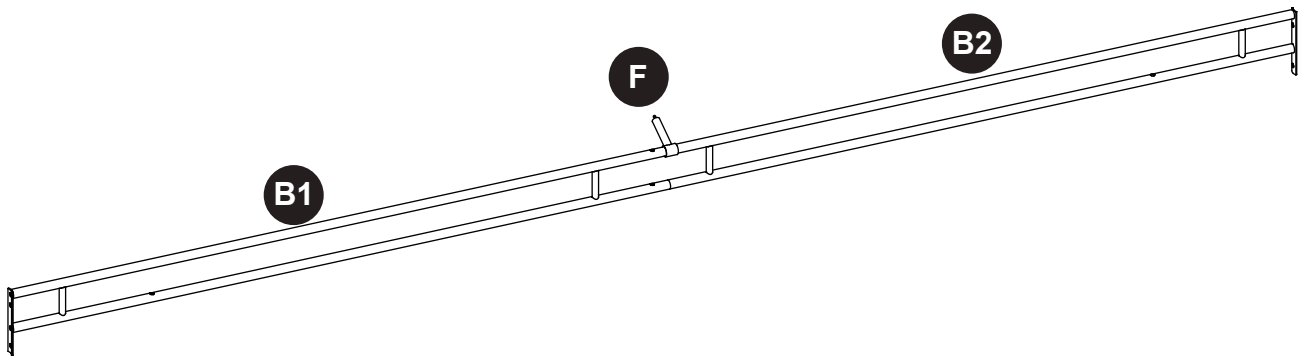

<b>CC</b>		x8	<b>JJ</b>		x2
<b>EE</b>		x16	<b>GG</b>		x8
<b>FF</b>		x8			

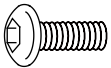

1. Junte el dintel (B1/B2) con el conector (F) y fíjelo con el perno (CC), la arandela plana (EE) y la tuerca (FF). Apriete con la llave inglesa (JJ). Coloque la cubierta para perno (GG) en el perno (CC).

# INSTRUCCIONES DE INSTALACIÓN

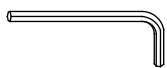
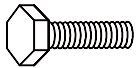
## 2 Aditamentos

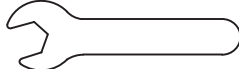
<b>AA</b>		x4	<b>EE</b>		x12
<b>II</b>		x1	<b>BB</b>		x8
<b>GG</b>		x8	<b>II</b>		x1

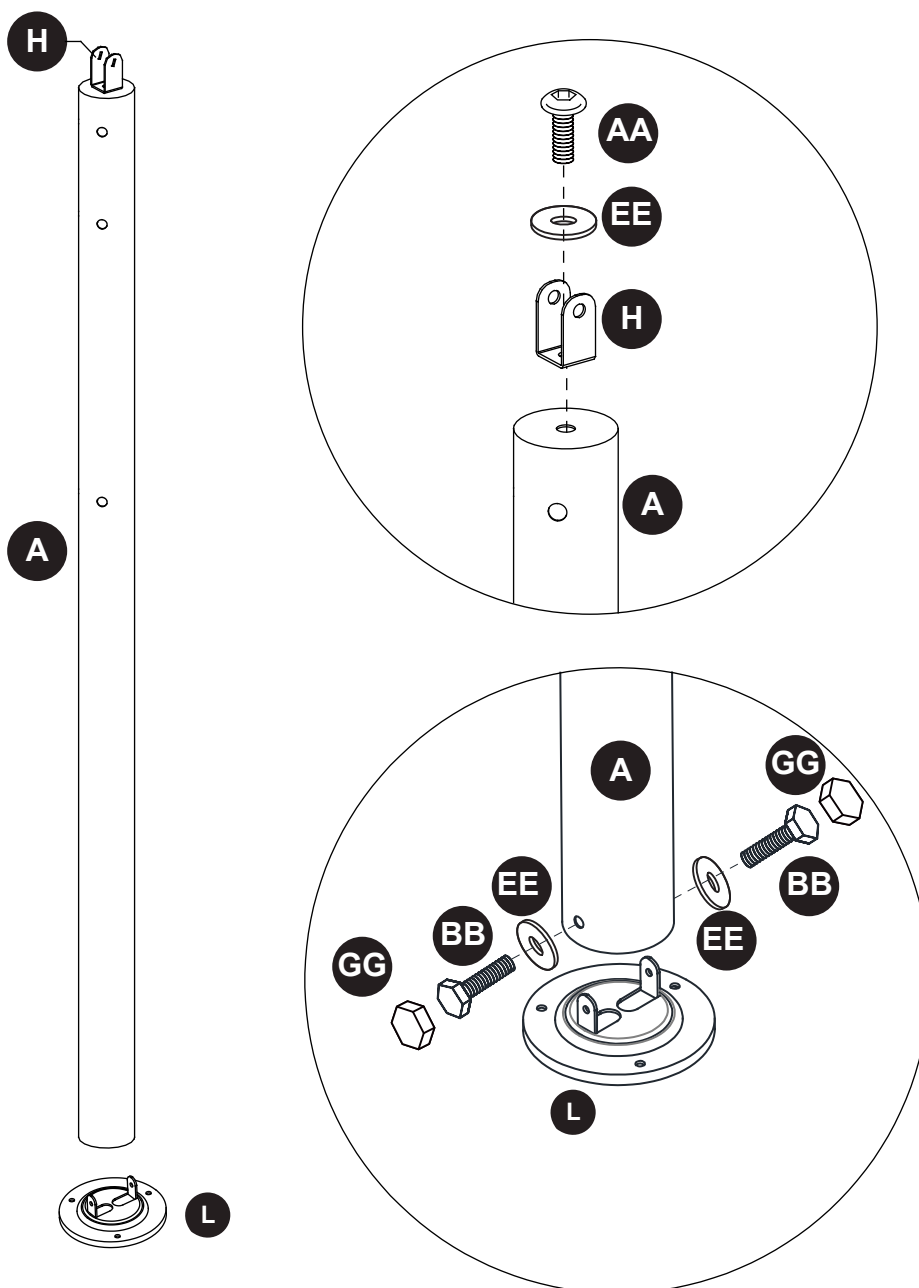





2.1 Junte el conector (H) con el poste (A) y fíjelo con el perno (AA) y la arandela plana (EE). No lo apriete con la llave Allen (II).

2.2 Fije la placa base (L) al poste (A) con el perno/la arandela/la tapa (BB/EE/GG).

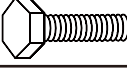
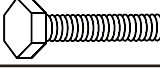
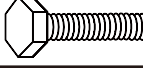
# INSTRUCCIONES DE INSTALACIÓN

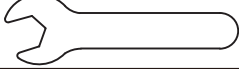
## 3 Aditamentos



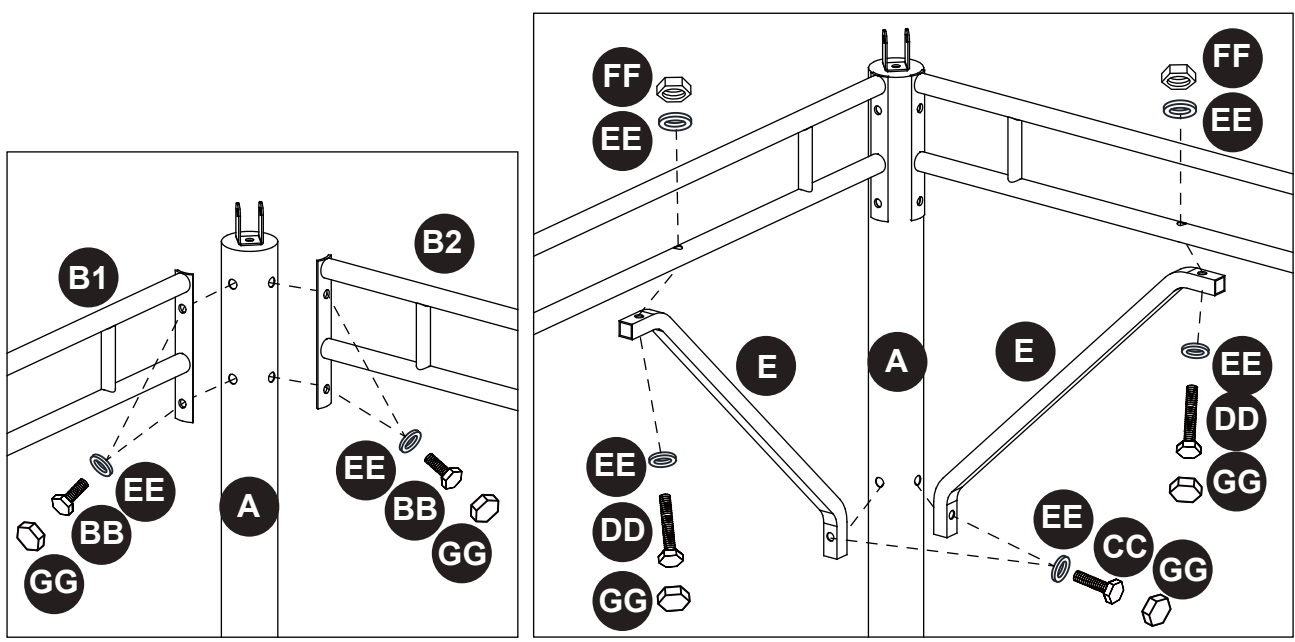
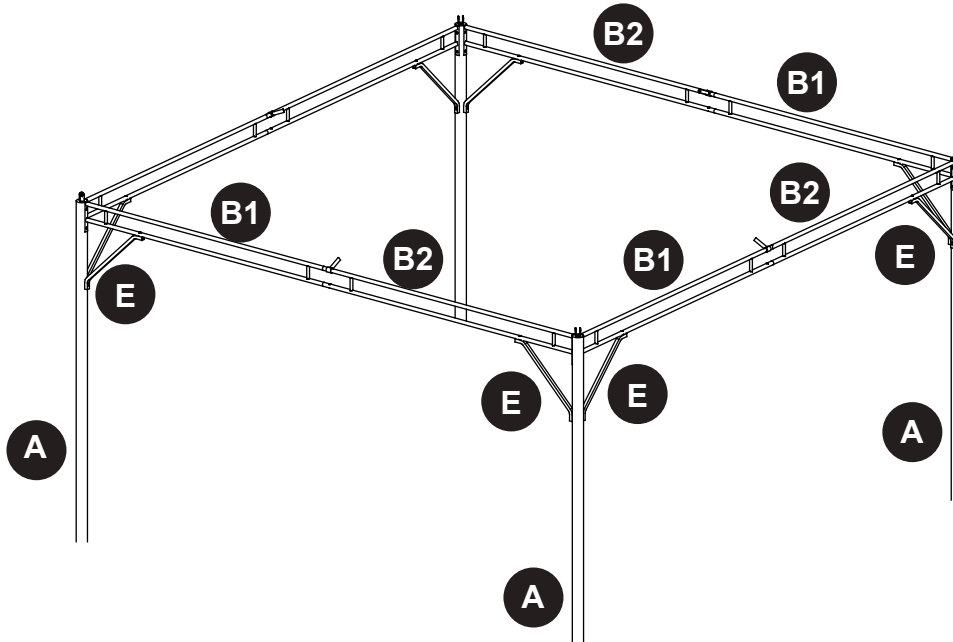

<b>BB</b>		x16	<b>DD</b>		x8
<b>CC</b>		x8	<b>GG</b>		x32
<b>EE</b>		x40	<b>JJ</b>		x2
<b>FF</b>		x8			

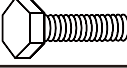
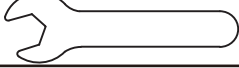

3. Junte los dinteles ensamblados (B1/B2) con el poste (A) y fijelos con el perno (BB), la arandela plana (EE). Luego, junte el soporte inclinado (E) con el poste (A) y los dinteles (B1/B2) y fijelo con el perno (CC/DD), la arandela plana (EE) y la tuerca (FF). Apriete con la llave inglesa (JJ). Coloque la cubierta para perno (GG) en el perno (BB/CC/DD).

# INSTRUCCIONES DE INSTALACIÓN

## 4 Aditamentos utilizados

<b>KK</b>		x4	<b>JJ</b>		x2
<b>EE</b>		x8	<b>GG</b>		x4
<b>FF</b>		x4			

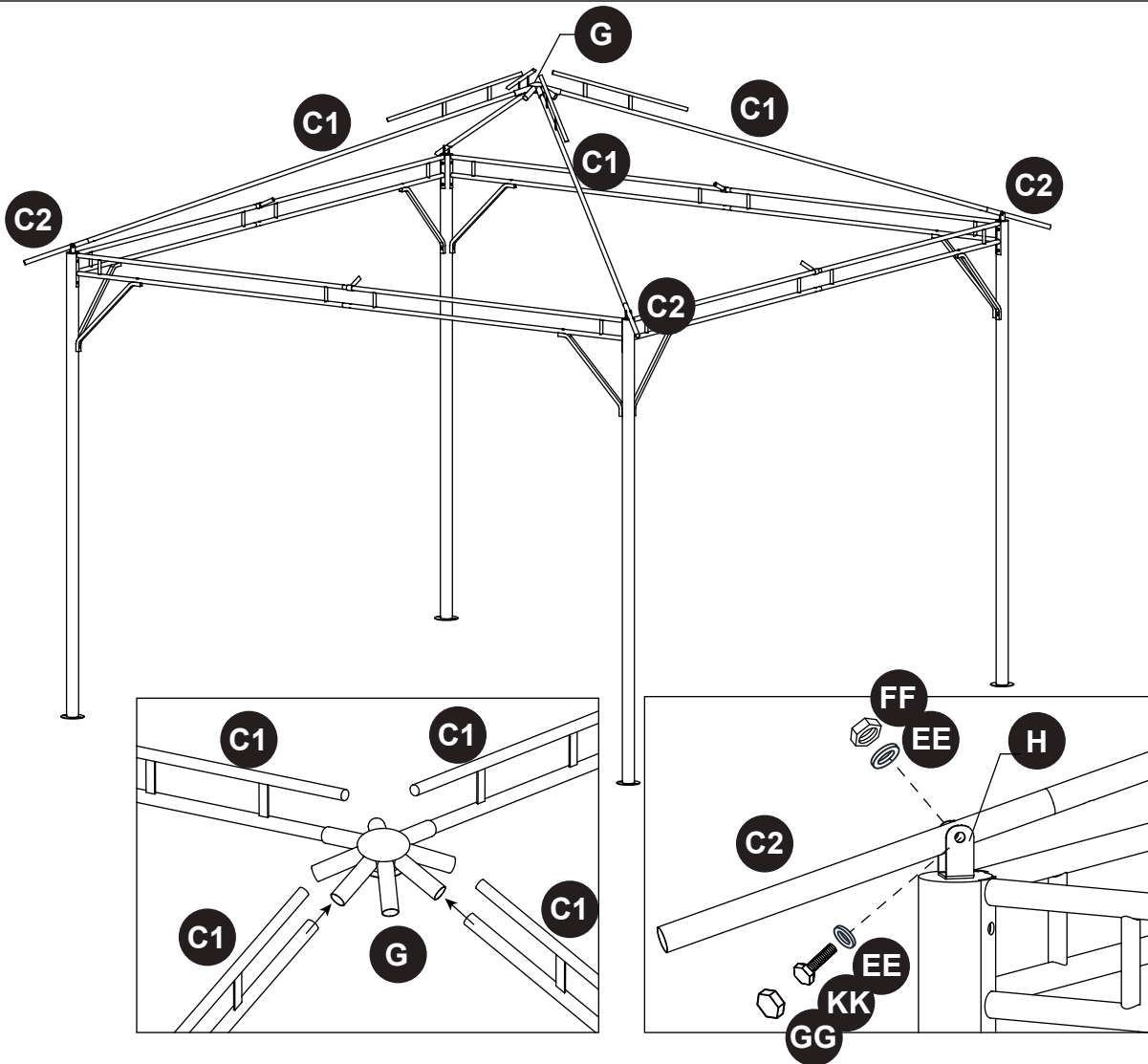
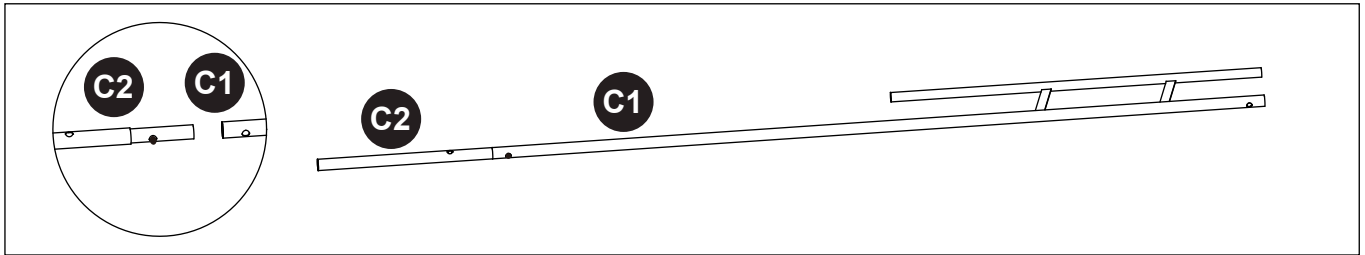

4. Inserte el soporte del techo (C2) en el soporte del techo (C1) y luego inserte el soporte del techo (C1) en el dispositivo central (G). A continuación, junte el soporte del techo (C2) con el conector (H) y fíjelo con el perno (KK), la arandela plana (EE) y la tuerca (FF). Apriete con la llave inglesa (JJ). Coloque la cubierta para perno (GG) en el perno (KK).

5

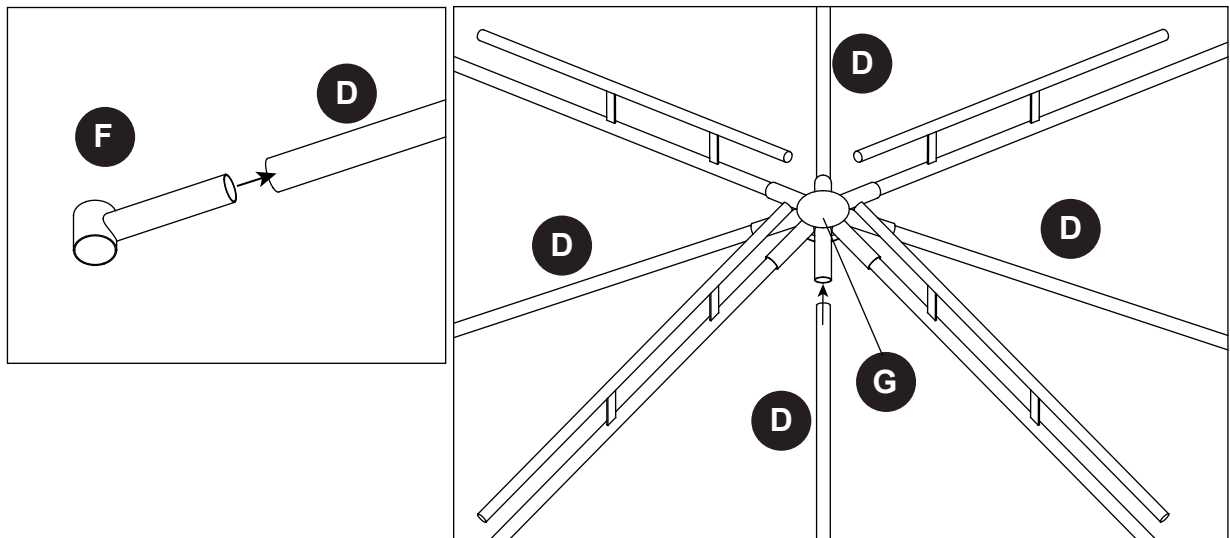
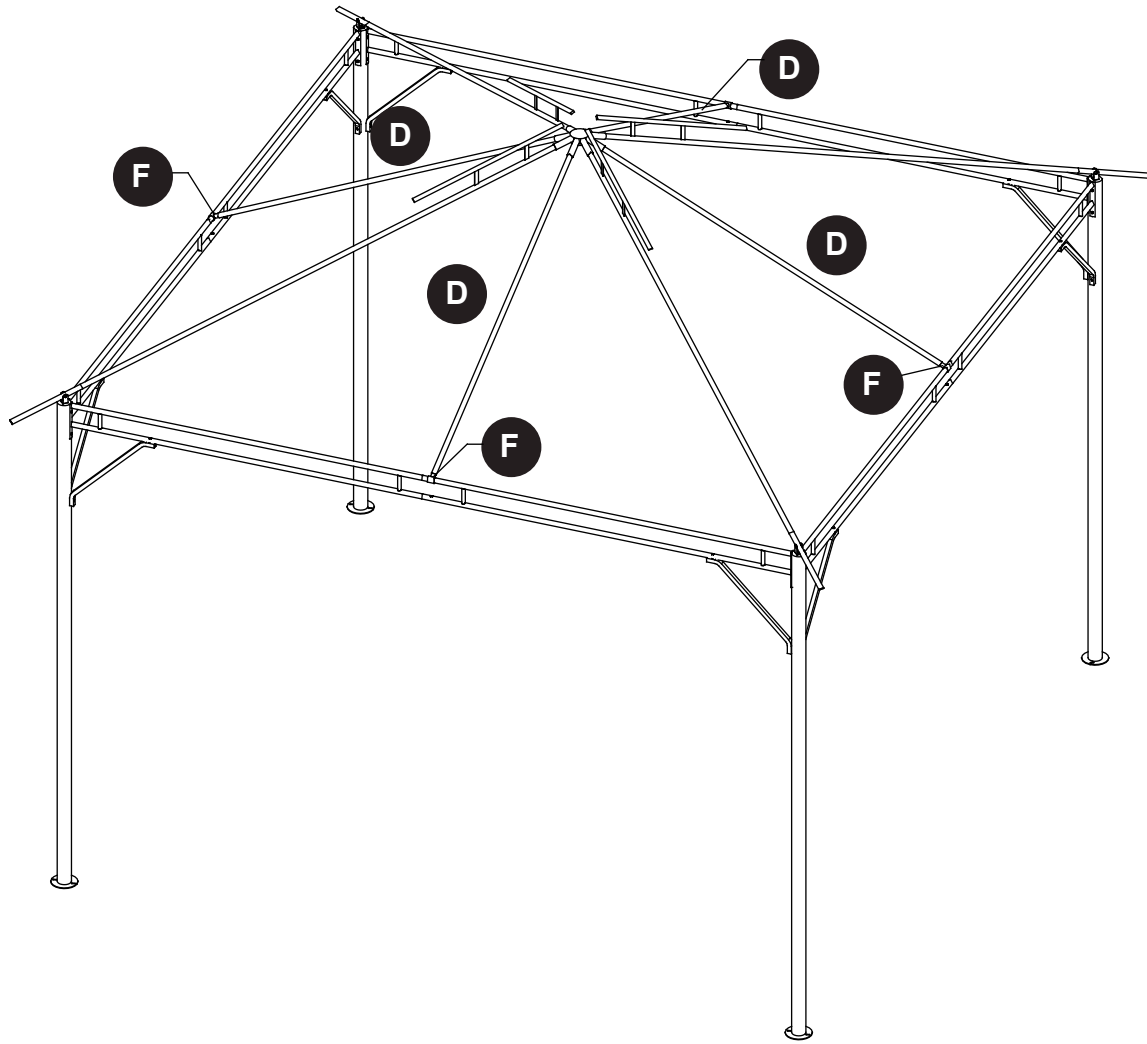

5. Inserte el conector (F) en el soporte del techo (D) y luego inserte este en el dispositivo central (G).

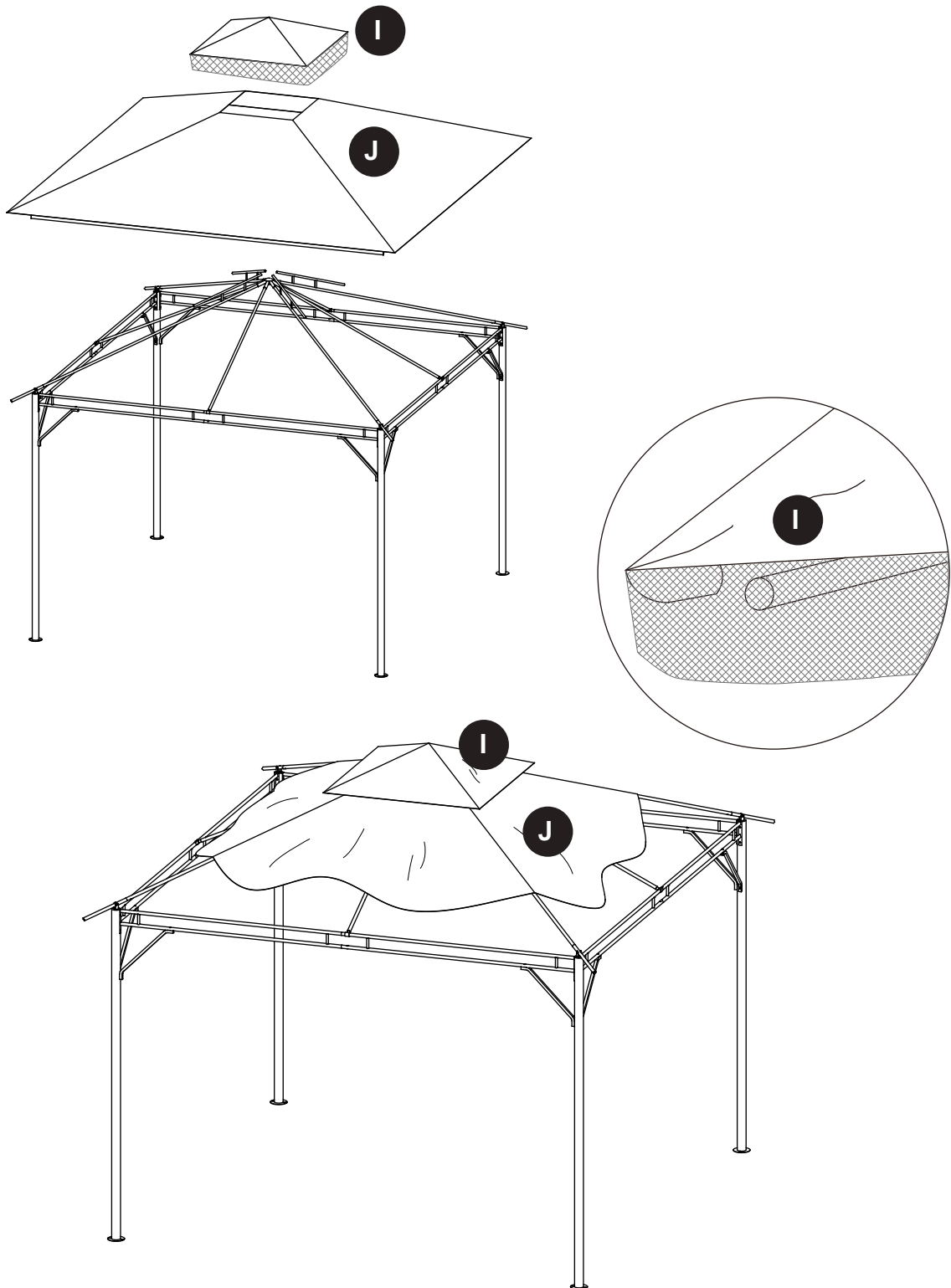

6. Coloque la cubierta grande (J) en la estructura del techo inferior. No extienda la cubierta grande en este paso. Coloque la cubierta pequeña (I) en la estructura superior del techo y luego fije las cuatro esquinas de esta a la estructura superior.

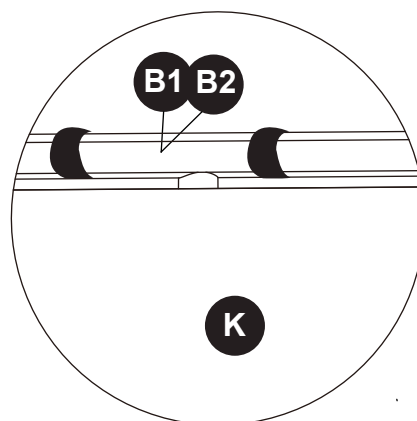
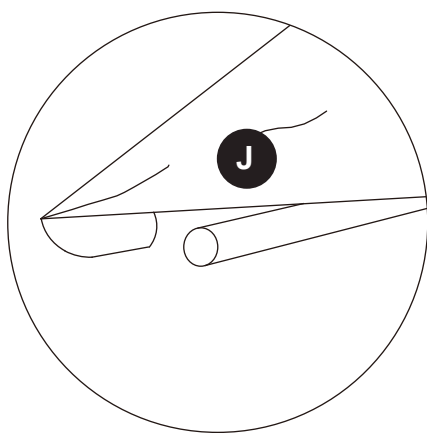
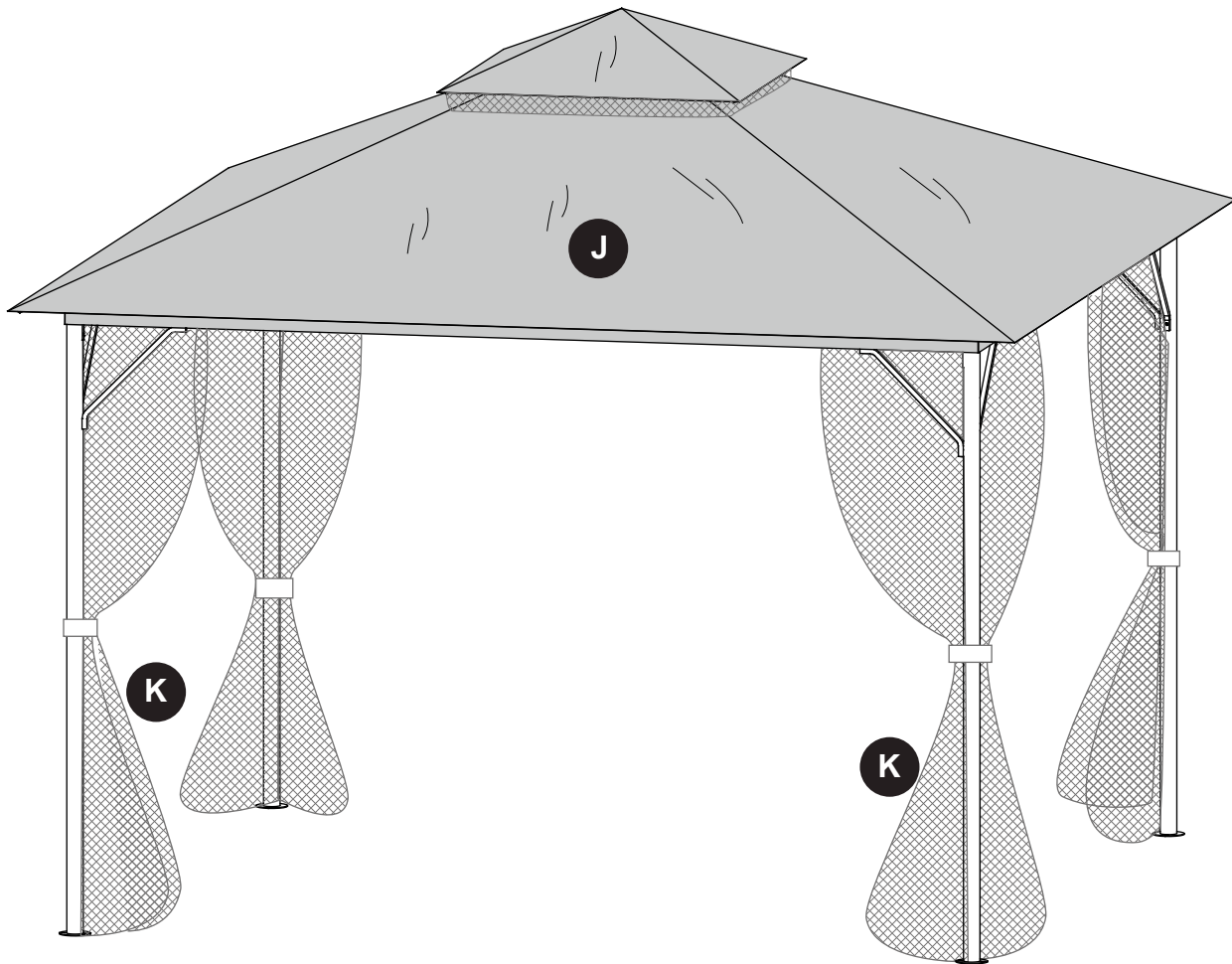

- 7.1 Extienda la cubierta grande (J) en la estructura del techo inferior. Fije las esquinas de la cubierta grande a los extremos de las estructuras inferiores.
- 7.2 Fije los mosquiteros (K) a los dinteles (B1/B2).

## INSTRUCCIONES DE INSTALACIÓN

8

Aditamentos utilizados

HH		x8
----	---	----

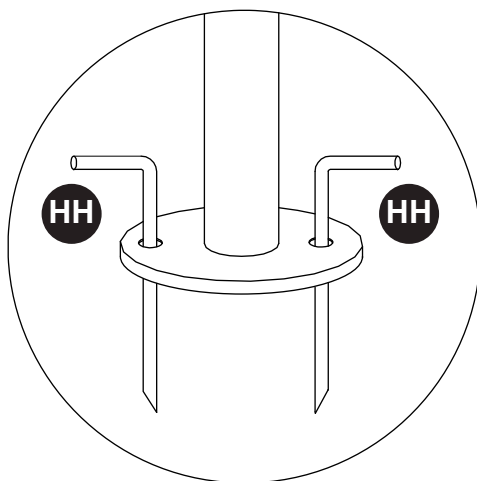
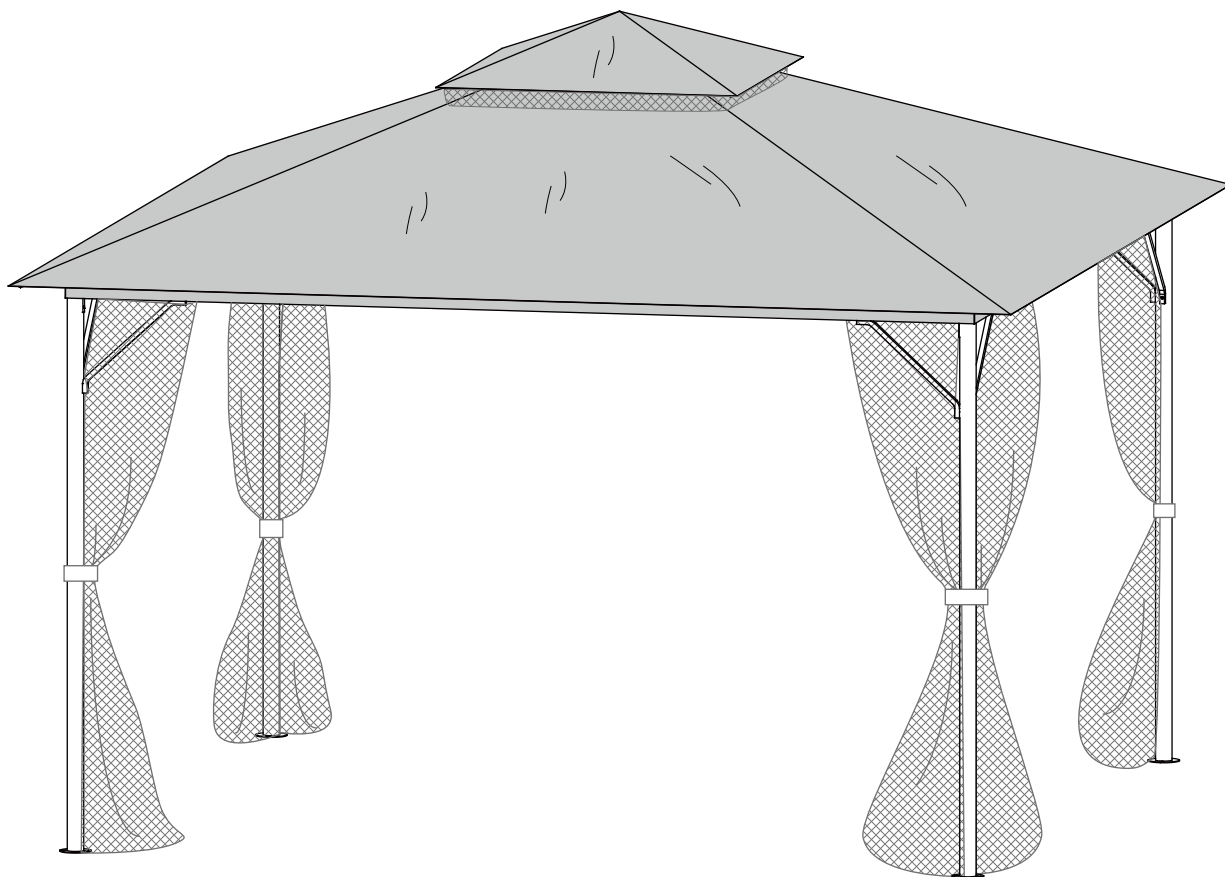

8. Asegure el gazebo al suelo por medio de las estacas (HH). Repita este paso para cada poste hasta que los cuatro postes estén clavados.

## CUIDADO Y MANTENIMIENTO

---

- Para limpiar, use una solución de detergente suave, enjuague con agua y deje secar al aire. No use acetona, productos abrasivos u otros detergentes especiales porque dañarían el acabado del producto.
- Debido a la naturaleza del acero, puede producirse una oxidación superficial si este recubrimiento protector se raya. Este es un proceso natural. Para minimizar esta condición, se recomienda que tenga cuidado cuando ensamble o manipule el producto, para evitar que la pintura se raye.

## GARANTÍA

---

### 1 AÑO DE GARANTÍA PARA LA ESTRUCTURA Y LA TELA.

#### • QUÉ CUBRE LA GARANTÍA

Para la compra original, ofrecemos una garantía de 1 año para la estructura y la tela a partir de la fecha de compra. La tela y la estructura se reemplazarán sin costo debido a defectos de fabricación.

#### • QUÉ NO CUBRE LA GARANTÍA

No realizamos reembolsos por los costos de transporte. Esta garantía no cubre daños provocados por el uso comercial, los desastres naturales, los incendios, el congelamiento ni el abuso del producto. Tampoco cubre la decoloración o el desteñido del acabado o las telas como resultado de la exposición a productos químicos o derrames.

Póngase en contacto con el equipo de Servicio al Cliente al **877-888-8225**.

## LISTA DE PIEZAS DE REPUESTO

---

Para obtener piezas de repuesto, llame a nuestro Departamento de Servicio al Cliente al **877-888-8225**, de lunes a domingo, de 8 a.m. a 8 p.m., hora estándar del Este. También puede ponerse en contacto con nosotros a través de. You could also contact us at **ascs@lowes.com**.

PIEZA	DESCRIPCIÓN	PIEZA #	CUBIERTO POR LA GARANTÍA
A	Poste	6034648-A	SÍ
B1	Dintel	6034648-B1	SÍ
B2	Dintel	6034648-B2	SÍ
C1	Soporte de techo	6034648-C1	SÍ
C2	Soporte de techo	6034648-C2	SÍ
D	Soporte de techo	6034648-D	SÍ
E	Soporte inclinado	6034648-E	SÍ
F	Conector	6034648-F	SÍ
G	Dispositivo central	6034648-G	SÍ
H	Conector	6034648-H	SÍ
I	Cubierta pequeña	6034648-I	SÍ
J	Cubierta grande	6034648-J	SÍ
K	Mosquiteros	6034648-K	SÍ
L	Placa base	6034648-L	SÍ
AA-KK	Paquete de aditamentos	6034648-AA-KK	SÍ