

**VIGO Ileana Single Hole Bathroom Faucet
VG01042**

PRODUCT FEATURES

- 1 or 3-hole installation
- Built from lead-free solid brass construction
- Eco-friendly 1.2 GPM flow rate
- Designed in NYC
- PerformanceSpout™ conserves water without sacrificing performance.
- FinishPlated™ ensures that the hardware finish is consistent throughout the entire sink faucet
- EternalSeal™ is an expertly tested ceramic cartridge that prevents leaks and dripping
- EZInstall™ makes installation quick and easy without the use of putty
- Power Meets Tranquility with an Eco-Friendly Flow
- Easy-to-Clean Nozzle Resists Mineral Buildup
- Features a quality assured Limited Lifetime Warranty
- Versatile Designs for Any Aesthetic
- All parts & hardware are included

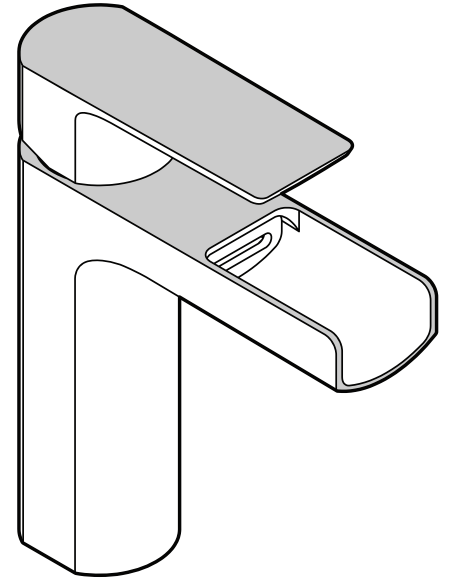

CODES / STANDARDS



- cUPC, NSF-61, AB1953 and WaterSense certified by IAPMO
- All VIGO Bathroom Faucets have a Limited Lifetime Warranty*





MATERIAL

- Housing material: Brass
- Valve material: Ceramic
- VIGO 7-layer coated finish resists corrosion and tarnish, maintaining a pristine look for years to come.

WATER CONSERVATION

Promoting a sustainable lifestyle, the 1.2 GPM faucet spout conserves water without sacrificing performance.

AVAILABLE FINISHES

Color**	Code	Description
	CH	Chrome
	BN	Brushed Nickel
	MB	Matte Black
	MG	Matte Brushed Gold
	GB	Graphite Black

* See website for detailed warranty information.

**Color swatches intended for reference only.

VIGO Ileana Single Hole Bathroom Faucet
VG01042

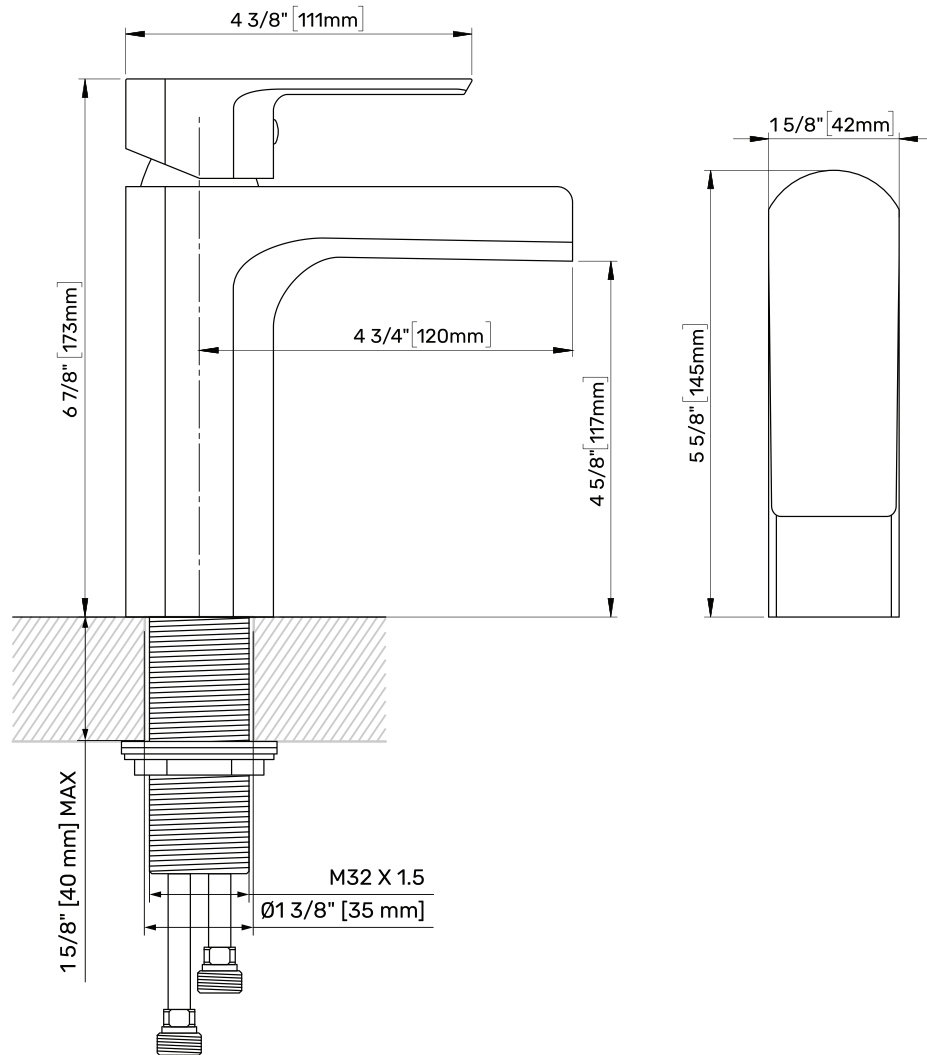

DIMENSIONS			
Faucet height	6 7/8" (173mm)	Diameter Opening	Standard 1 3/8" diameter opening is required
Spout reach	4 3/4" (120mm)	Water supply connection	Standard US plumbing 3/8" connections
Spout height	4 5/8" (117mm)	Installation compatibility	1 or 3-hole
Hole Diameter	Ø1 3/8" (35mm)		
Flow rate	1.2 gal/min		
Faucet body	Brass		

NOTE

Install this product according to the installation instructions.

VIGO reserves the right to make revisions without prior notice.

For the most updated specifications, please go to:

www.vigoindustries.com

or email us at:

support@vigoindustries.com

QUESTIONS?

For installation help, missing or replacement parts, please contact our product specialist for consultation.

☎ +1 866-591-7792 (Option 2) (9:30am - 5:30pm EST) ✉ techmail@vigoindustries.com

CONNECT WITH US





vigoindustries