

### Features

- Round-front bowl.
- Comfort Height®.
- AquaPiston® flushing system.
- Touchless Technology allows hands-free operation to actuate the flush.
- Less seat and supply.
- 1.28 (4.8 lpf)
- 2-1/8" (54 mm) glazed trapway.
- 11-1/2" (292 mm) x 9-1/4" (235 mm) water area.

### Material

- Vitreous china.

### Installation

- 12" (305 mm) rough-in.
- 27-1/4" (692 mm) x 17-5/8" (448 mm) x 30-1/2" (775 mm)

### Recommended Accessories

- K-4639 Round-Front Toilet Seat
- K-5589 Round-Front Toilet Seat
- K-76923 Round-Front Manual Cleansing Toilet Seat
- K-5420 Low-Profile Bolt Caps

### Components

Product includes:

- K-4347 Comfort Height® Round-front Bowl
- K-5693 Toilet Tank Round-Front Touchless
- Additional included component/s: Touchless Flush Kit.



ADA CSA B651 OBC

### Codes/Standards







ASME A112.19.2/CSA B45.1  
DOE - Energy Policy Act 1992  
EPA WaterSense®  
California Energy Commission (CEC)  
ADA  
ICC/ANSI A117.1  
CSA B651  
OBC

### KOHLER® One-Year Limited Warranty

See website for detailed warranty information.

### Available Color/Finishes

*Color tiles intended for reference only.*

| Color  | Code | Description  |
|--|------|--------------|
|  | 0    | White        |
|  | 96   | Biscuit      |
|  | 47   | Almond       |
|  | NY   | Dune         |
|  | 95   | Ice™ Grey    |
|  | G9   | Sandbar      |
|  | 7    | Black Black™ |

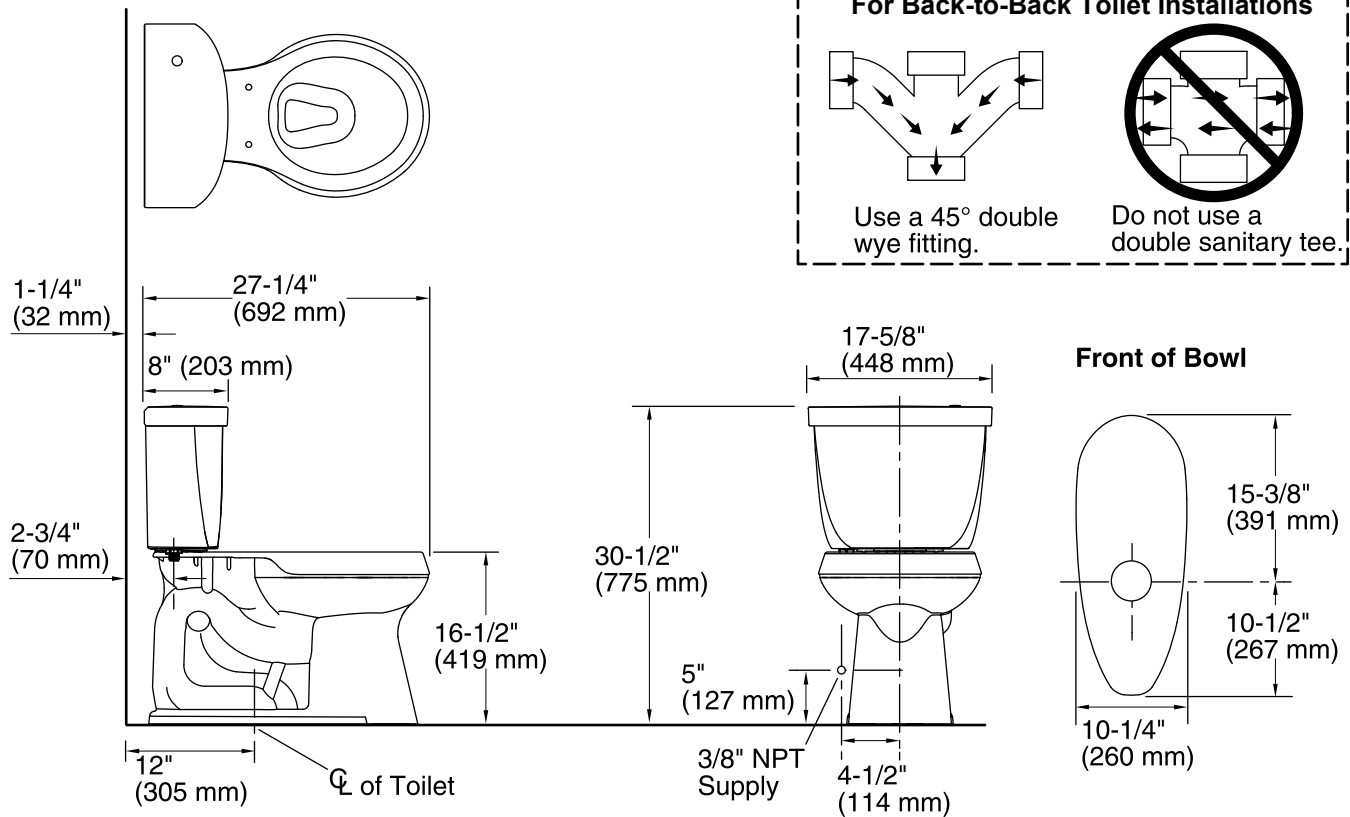

## Technical Information

All product dimensions are nominal.

|                       |                                    |
|-----------------------|------------------------------------|
| Toilet type:          | Two-piece                          |
| Bowl shape:           | Round front                        |
| Trap passageway:      | 2-1/8" (54 mm)                     |
| Water Consumption     |                                    |
| Full:                 | 1.28 gpf (4.8 lpf)                 |
| Water surface size:   | 11-1/2" x 9-1/4" (292 mm x 235 mm) |
| Rim to water surface: | 5-1/4" (133 mm)                    |
| Seat-mounting holes:  | 5-1/2" (140 mm)                    |

## Notes

Install this product according to the installation instructions.

For back-to-back toilet installations: Use only a 45° double wye fitting.

ADA, OBC, CSA B651 compliant when installed to the specific requirements of these regulations.

Plumbing Codes require elongated toilets and elongated, open-front toilet seats in public bathrooms.

Accessibility standards require controls to be located on the open side of the toilet.