



Manufactured by:  
Backyard Discovery  
3305 Airport Drive, Pittsburg, KS 66762  
800-856-4445

*Basepoint Business Centre: Rivermead Drive, Westlea, Swindon SN5 7EX Phone: 0800-118-2476  
J.P. Coenstraat 7, The Bridge, The Hague, 2595 WP, Netherlands Phone: 08005678990*

# RYLAN 4P CORNER INDOOR INFRARED SAUNA

**MODEL #: 2504752, 2504752-V**



Please visit [www.backyarddiscovery.com](http://www.backyarddiscovery.com)  
For the most up to date assembly manual, to register your product, or to order  
replacement parts Para obtener instrucciones en español, visite  
[www.backyarddiscovery.com](http://www.backyarddiscovery.com)

# OWNER'S MANUAL - BASIC SETUP DIMENSIONS & ASSEMBLY NOTES

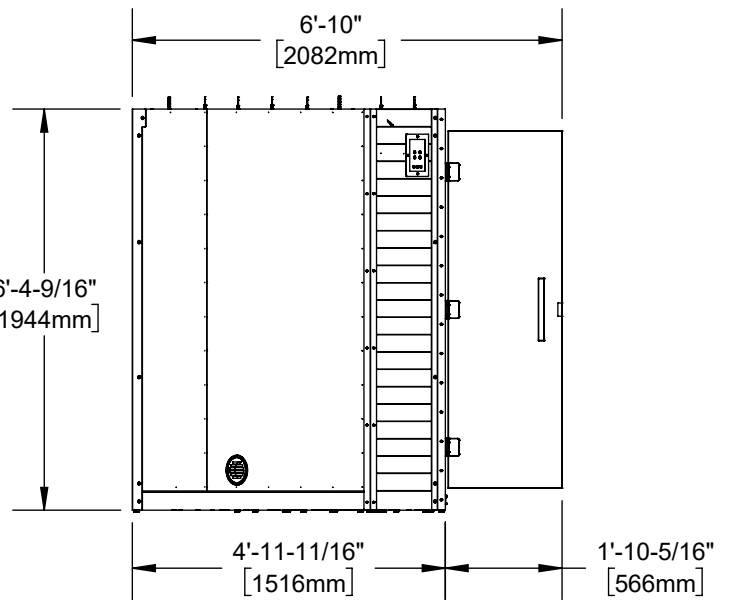
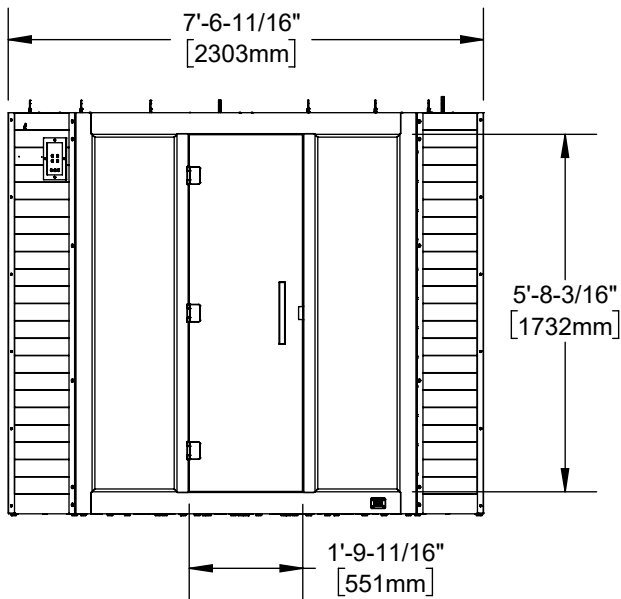
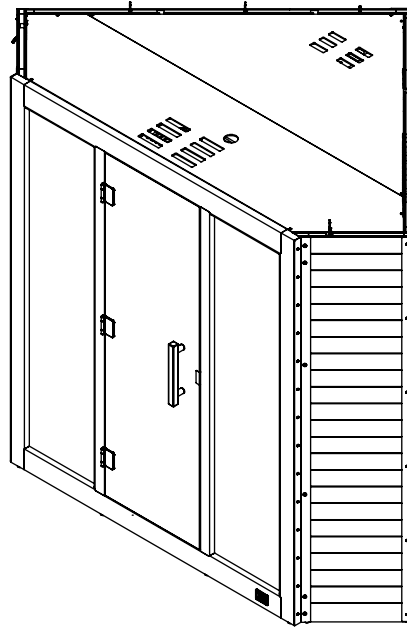
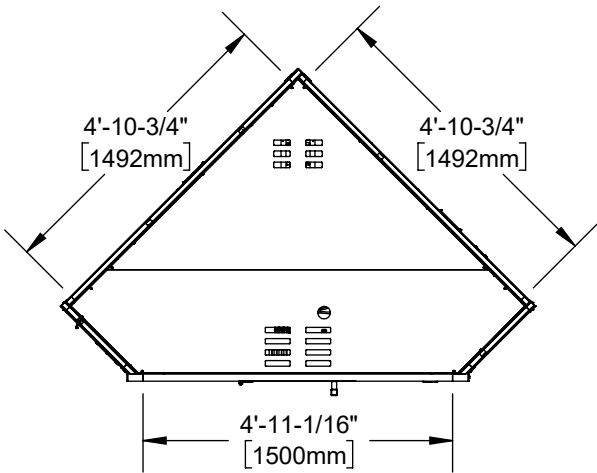

# OWNER'S MANUAL - GENERAL INFORMATION

FOR INDOOR USE ONLY  
240V AC / 20AMP DEDICATED CIRCUIT REQUIRED

---

**WARNING:** Before assembly, visually inspect all heaters for any signs of damage. Excessive vibrations during transport may harm the heating elements. **DO NOT START** the sauna if any damage is detected. Contact Backyard Discovery for troubleshooting and replacement parts.

Replacement Parts: When replacement parts are needed, ensure they meet the manufacturer's specified requirements. Unauthorized substitutes may result in fire, electrical shock, or other hazards. Please contact Customer Service directly for the repair parts.

---

Note: Your sauna has been completely assembled and tested prior to packaging.

**TWO adults are needed for assembly.**

Choose a good indoor location to install the sauna:

- Location should be dry, level, well ventilated, temperature controlled and away from any source of water.
  - Do not install the sauna near water sources such as bathtubs, showers, wet basements, or swimming pools where water may splash on the sauna.
  - Main power cord must be easily accessible.
  - Ensure the power supply cord does not create a trip hazard and is not pinched by surrounding objects.
  - Do not use wall receptacle adapters, surge protectors, or extension cords between the sauna cord and the wall outlet.
- 

Prolonged exposure is capable of inducing hyperthermia which occurs when the internal temperature of the body reaches a level several degrees above the normal body temperature of 98.6 °F. The symptoms of hyperthermia include an increase in the internal temperature of the body, dizziness, lethargy, drowsiness, and fainting. The effects of hyperthermia include:

- Failure to perceive heat;
- Failure to recognize the need to exit the room;
- Unawareness of impending hazard;
- Fetal damage in pregnant women;
- Physical inability to exit the room;
- Unconsciousness
- **WARNING** – The use of alcohol, drugs, or medication is capable of greatly increasing the risk of fatal hyperthermia.

## **GENERAL SAFETY WARNINGS:**

- Do not install shower heads, plumbing fixtures, or taps in the sauna.
- Do NOT install electrical outlets inside or on the outside the sauna structure.
- Do NOT add locks or latches to the sauna door to prevent accidental entrapment.
- Do NOT tamper with, block, or move vents or sensors on or behind the sauna.
- **WARNING:** Permits may be required. Check local building codes before installing.
- **CAUTION:** To prevent fire, do not place any combustible materials on or near the sauna heater.
- At the end of each day, check that the sauna is turned off.
- No additional electrical receptacles should be installed inside or outside the sauna structure.
- Do not install any locking or latching mechanisms on the door to prevent accidental entrapment.
- If manually resettable temperature-limiting controls are frequently triggered, contact customer service and a qualified service provider.
- Do not tamper with, reposition, or cover vents or sensors on top of or behind the sauna.

# OWNER'S MANUAL - GENERAL INFORMATION

## FCC Warning

This device complies with part 15 of the FCC Rules. Operation is subject to the following two conditions: (1) This device may not cause harmful interference, and (2) this device must accept any interference received, including interference that may cause undesired operation.

**Note:** This equipment has been tested and found to comply with the limits for a Class B digital device, pursuant to part 15 of the FCC Rules. These limits are designed to provide reasonable protection against harmful interference in a residential installation. This equipment generates, uses and can radiate radio frequency energy and, if not installed and used in accordance with the instructions, may cause harmful interference to radio communications. However, there is no guarantee that interference will not occur in a particular installation. If this equipment does cause harmful interference to radio or television reception, which can be determined by turning the equipment off and on, the user is encouraged to try to correct the interference by one or more of the following measures:

- Reorient or relocate the receiving antenna.
- Increase the separation between the equipment and receiver.
- Connect the equipment into an outlet on a circuit different from that to which the receiver is connected.
- Consult the dealer or an experienced radio/TV technician for help.

**Note:** The Grantee is not responsible for any changes or modifications not expressly approved by the party responsible for compliance. Such modifications could void the user's authority to operate the equipment.

The device has been evaluated to meet general RF exposure requirement.

To maintain compliance with FCC's RF exposure guidelines, the distance must be at least 20 cm between the radiator and your body, and fully supported by the operating and installation

---

This device contains licence-exempt transmitter(s)/receiver(s) that comply with Innovation, Science and Economic Development Canada's licence-exempt RSS(s). Operation is subject to the following two conditions:

- (1) This device may not cause interference.
- (2) This device must accept any interference, including interference that may cause undesired operation of the device.

The device has been evaluated to meet general RF exposure requirement. To maintain compliance with RSS-102

- Radio Frequency (RF) Exposure guidelines, this equipment should be installed and operated with a minimum distance of 20cm between the radiator and your body.

# OWNER'S MANUAL - PARTS IDENTIFICATION

WOOD COMPONENTS (NOT TO SCALE)

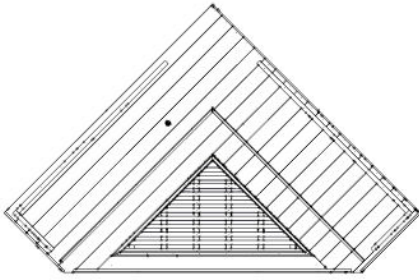

**P01 FLOOR PANEL - W2A04905**  
(x1) 5 1/16"x58 3/16"x64 1/16" (128x1478x1627)

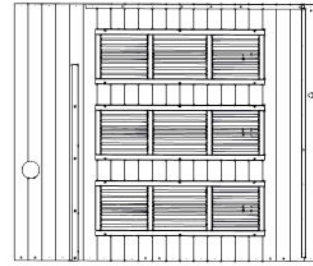

**P02 BACK WALL PANEL RIGHT - W2A04902**  
(x1) 2 11/16"x72 13/16"x61 3/8" (69x1850x1558)

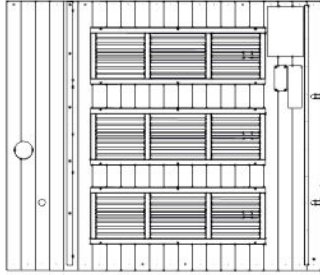

**P03 BACK WALL PANEL LEFT - W2A04901**  
(x1) 2 11/16"x62 11/16"x72 13/16" (69x1591x1850)

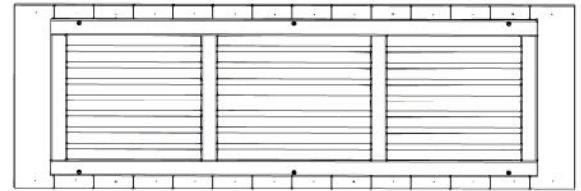

**P04 SEAT SUPPORT PANEL RIGHT - W2A04898**  
(x1) 2 11/16"x15 3/8"x46 3/4" (69x390x1187)

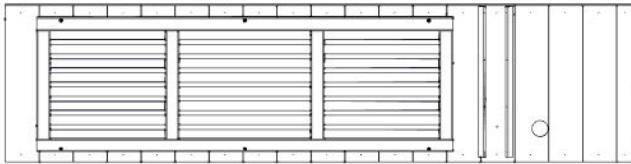

**P05 SEAT SUPPORT PANEL LEFT - W2A04897**  
(x1) 2 11/16"x15 3/8"x61 3/16" (69x390x1554)

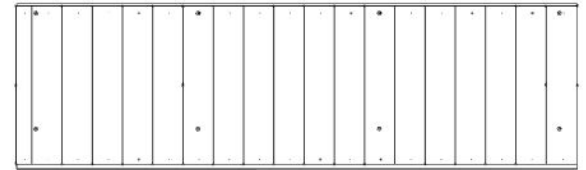

**P06 SEAT PANEL - W2A04900**  
(x1) 61 1/4"x18 3/16"x1 3/4" (44x461x1556)

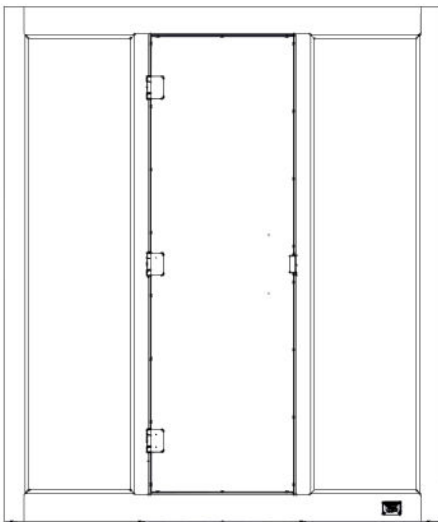

**P07 DOOR PANEL - W2A04904**  
(x1) 1 3/8"x65"x76 1/2" (36x1652x1944)

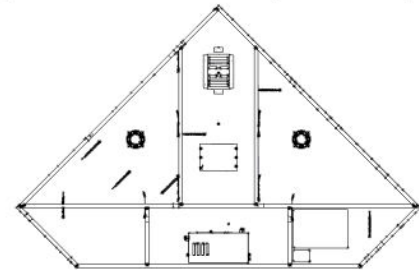

**P08 ROOF PANEL - W2A04903**  
(x1) 56 1/8"x86 3/8"x56 1/8" (70x2194x1425)

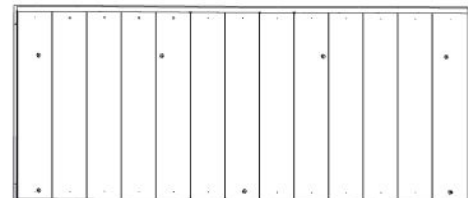

**P09 SEAT PANEL - W2A04899**  
(x1) 1 3/4"x18 3/16"x43 1/8" (44x461x1095)



**P10 RIGHT WALL PANEL - W2A04907**  
(x1) 2 3/8"x19 5/8"x72 13/16" (61x499x1850)

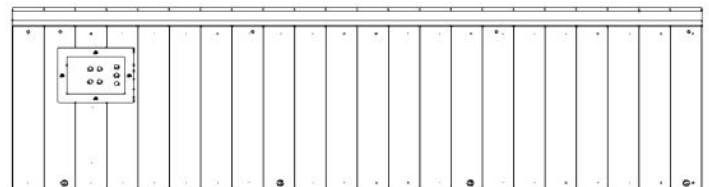

**P11 LEFT WALL PANEL - W2A04906**  
(x1) 2 9/16"x19 5/8"x72 13/16" (65x499x1850)

# OWNER'S MANUAL - PARTS IDENTIFICATION

WOOD COMPONENTS (NOT TO SCALE)



**OO01 HANDLE BAR - W4L21815**  
(x1) 1 3/16"x1 3/16"x11 15/16" (30x30x304)

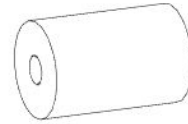

**HS01 HANDLE STANDOFF - W4L21813**  
(x2) 15/16"x1 5/8" (x24x42)



**H01 HANDLE ASSEMBLY - W2A04763**  
(x1) 1 3/16"x1 3/16"x11 15/16" (30x30x304)

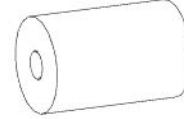

**HS02 HANDLE STANDOFF - W4L21814**  
(x2) 15/16"x1 5/8" (x24x42)

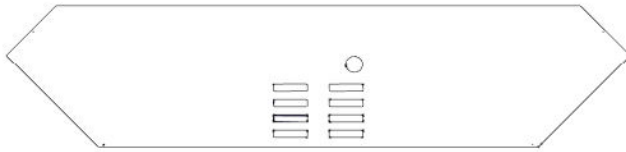

**R01 ROOF COVER - W4L22339**  
(x1) 3/16"x19 11/16"x86 1/2" (5x500x2198)

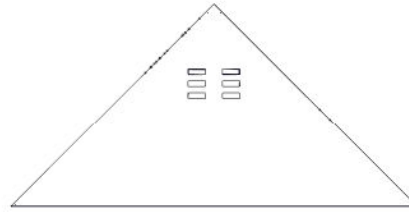

**R02 ROOF COVER - W4L22340**  
(x1) 3/16"x51 3/8"x72 11/16" (5x1305x1846)

# OWNER'S MANUAL - PARTS IDENTIFICATION

ACCESSORY COMPONENTS (NOT TO SCALE)



**5906 CORNER BRACKET - A4M05906**  
(x1) 3 5/8"x3 5/8"x76 9/16" (92x92x1944)



**6588 DOOR BRACKET - A4M06588**  
(x2) 1 1/8"x2 11/16"x76 9/16" (29x68x1944)

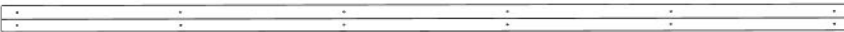

**A4M05358 CORNER GUARD**  
(x2)

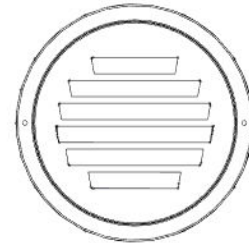

**A4M05585 VENT**  
(x2)

# OWNER'S MANUAL - PARTS IDENTIFICATION

## HARDWARE COMPONENTS

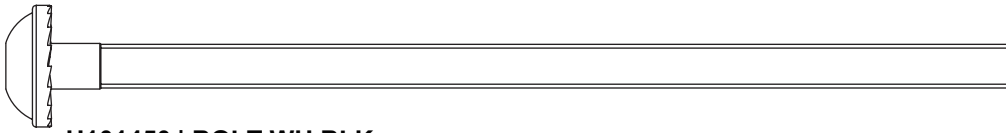

**H101450 | BOLT WH BLK**  
(x2) | 1/4x5

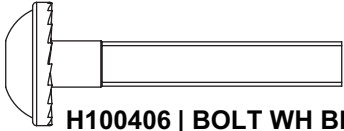

**H100406 | BOLT WH BLK**  
(x8) | 1/4x1-1 1/2

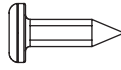

**H101409 | SCREW PPH BLK**  
(x8) | 4x1/2

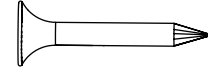

**H100385 | SCREW PFH**  
(x29) | 8 X 1 BLK

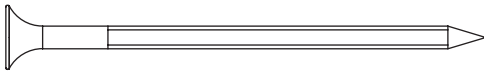

**H100201 | SCREW PFH BLK**  
(x15) | 8x2 1/2

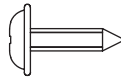

**H100408 | SCREW PFH BLK**  
(x28) | 8x1/2



**H100382 | SCREW PFH BLK**  
(x16) | 8x1 3/4

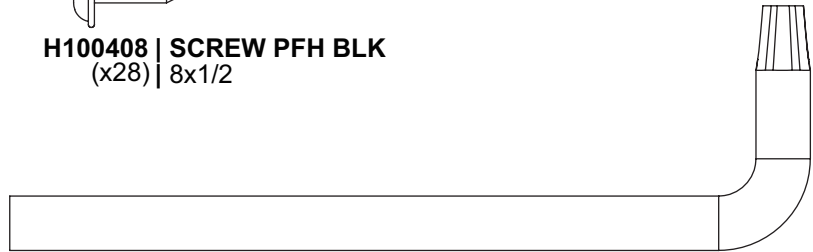

**H100114 | TORX WRENCH**  
(x1) | T-30

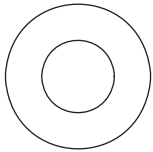

**H101403 | POLY WASHER**  
(x4) |

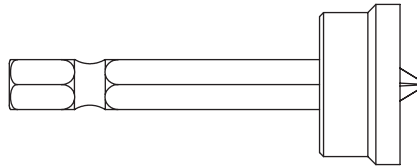

**H100764 | SCREW SETTER**  
(x1)

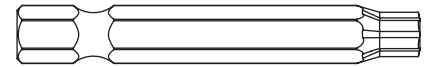

**H100147 | TORX BIT**  
(x1) | T-30

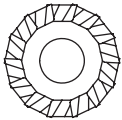

**H100405 | WASHER LOCK EXT BLK**  
(x10) | 6x15

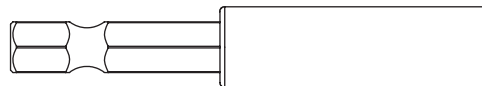

**H101100 | MAGNETIC DRIVER**  
(x1)

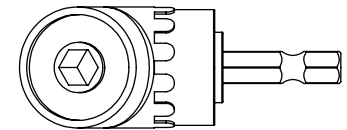

**H101114 | RIGHT ANGLE  
DRILL ADAPTER**  
(x1) |

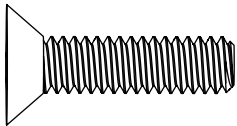

**H101462 | FLAT HEAD**  
(x20) | 1/4-20x2in

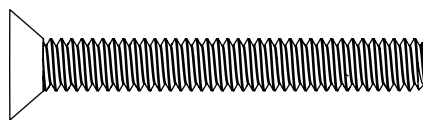

**H101463 | FLAT HEAD**  
(x4) | 1/4-20x2in

### WOOD PARTS:

- Organize wood parts by the three-digit, alpha-numeric number stamped on each board (ex. P01).
- If there are multiple boards with the same stamped number, stack those pieces together.
- Stamps can be found on the flat surface of the boards or on the end of the boards.
- Allow yourself plenty of room - the wood pieces can take up a significant amount of space.

**NOTE: CARTONS ARE NOT ORGANIZED BY PART OR STEP NUMBER.**



---

### HARDWARE PARTS:

- We recommend that you have a separate table to organize the hardware.
- Hardware bags are printed with a seven-digit, alpha-numeric part number.
- You can organize your hardware by part number or group by hardware type (e.g. bolts, nuts, etc.).
- During assembly you only need to reference the last four digits of the number.

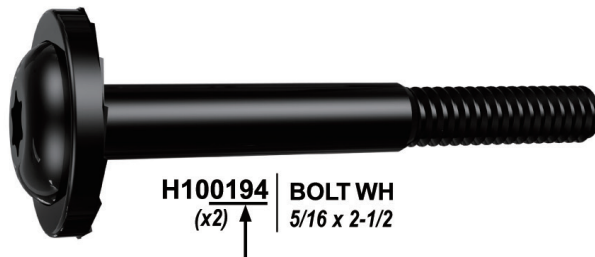

---

## PRE-ASSEMBLY STEP 1 - TOOLS REQUIRED



Cordless Drill or  
Electric Drill

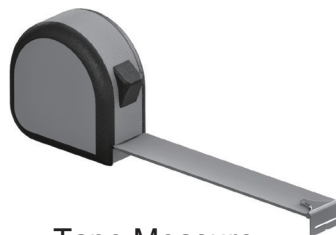

Tape Measure

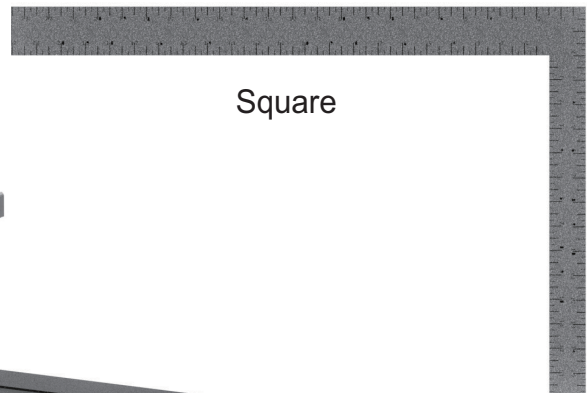

Square



Level 24"

# STEP 1 - SAUNA ASSEMBLY

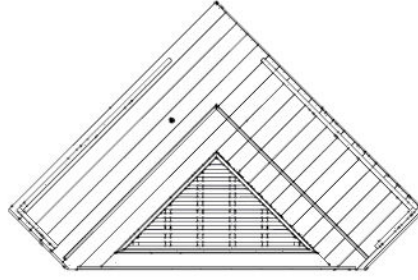

P01 FLOOR PANEL - W2A04905  
(x1) 5 1/16"x58 3/16"x64 1/16" (128x1478x1627)

- PLACE FLOOR PANEL IN DESIRED LOCATION OF SAUNA.

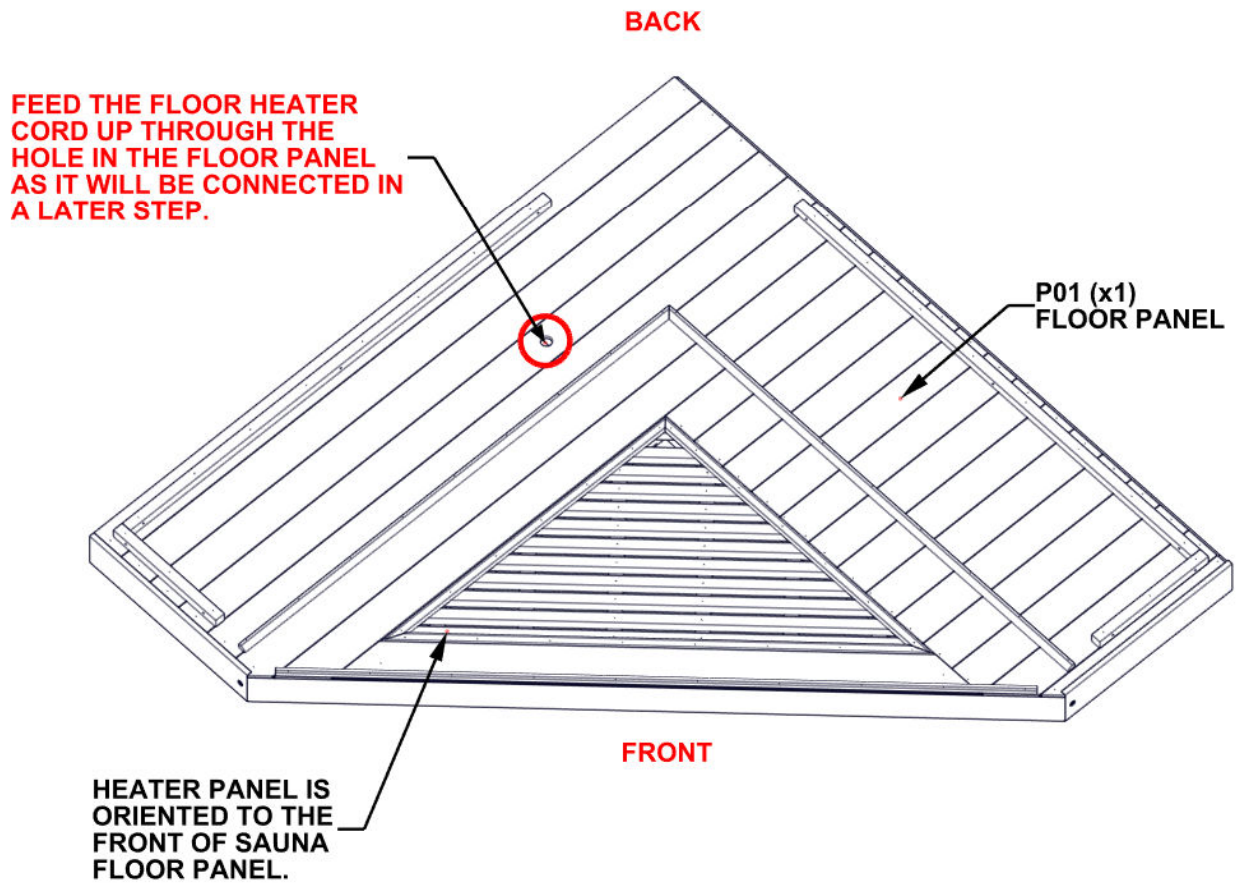

## STEP 2 - SAUNA ASSEMBLY

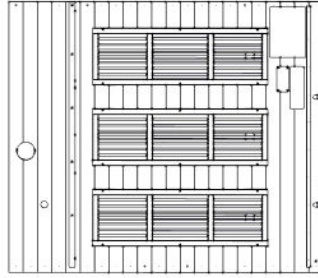

P03 BACK WALL PANEL LEFT - W2A04901  
(x1) 2 11/16"x62 11/16"x72 13/16" (69x1591x1850)

- STAND UP P03 AND ORIENT AS SHOWN.
- BACK AND SIDE OF P03 WILL BE FLUSH WITH BACK AND SIDE OF P01.
- ONE PERSON WILL HOLD UP AND SUPPORT P03 GOING TO THE NEXT STEP.

ENSURE HEATER CORDS  
ARE ACCESSIBLE AS THEY  
WILL BE CONNECTED IN A  
LATER STEP.

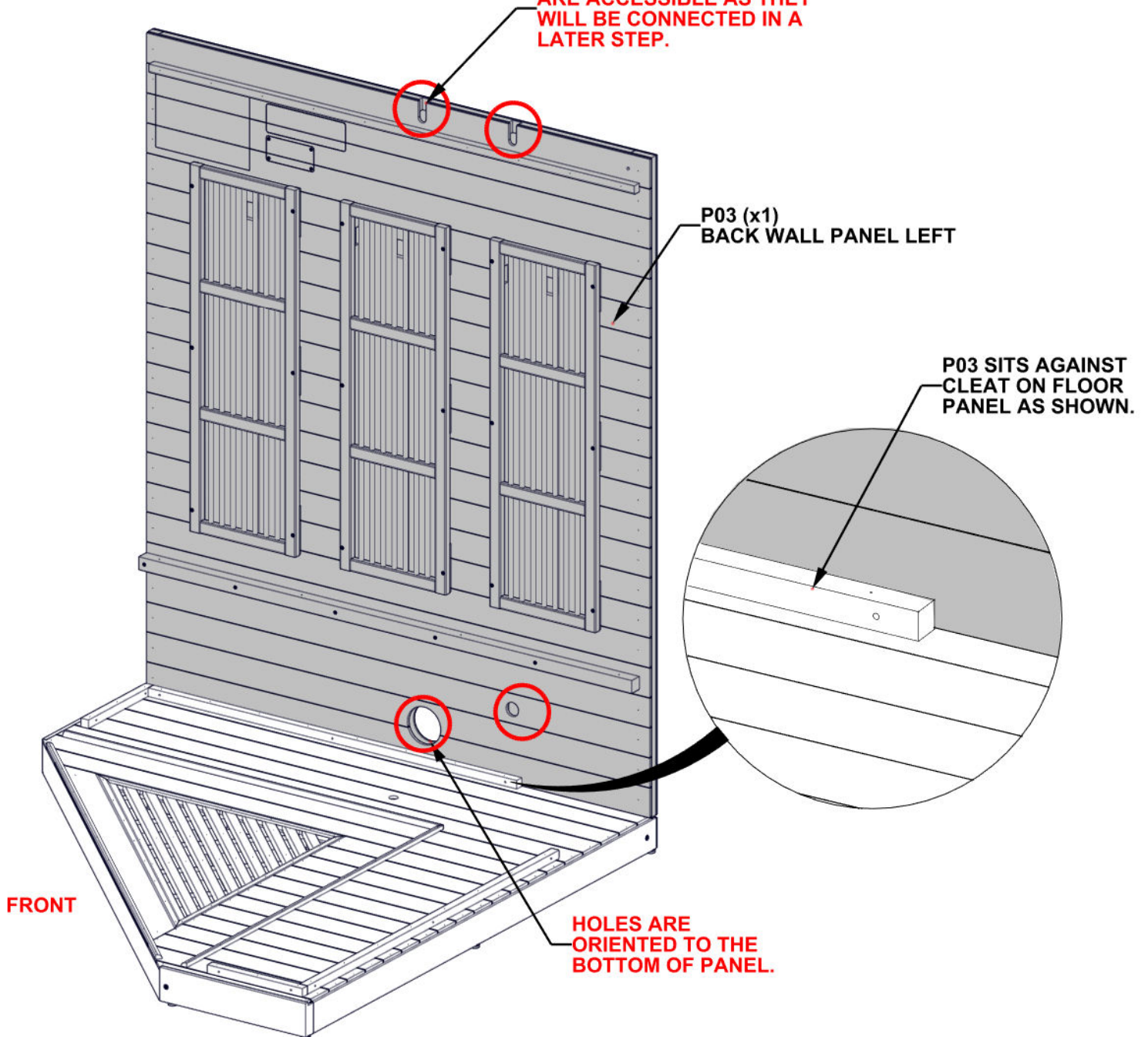

# STEP 3 - SAUNA ASSEMBLY

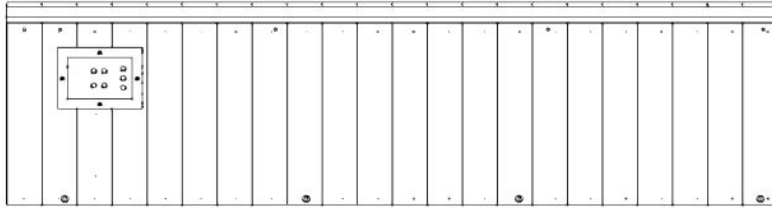

P11 LEFT WALL PANEL - W2A04906  
(x1) 2 9/16"x19 5/8"x72 13/16" (65x499x1850)

- STAND UP P11 AND ORIENT AS SHOWN.
- CONTROL PANEL SHOULD BE ORIENTED TO THE TOP.
- KEEP SUPPORTING P11 AND P03 AS PANELS ARE ATTACHED IN NEXT STEP.

**ENSURE HEATER CORDS ARE ACCESSIBLE AS THEY WILL BE CONNECTED IN A LATER STEP.**

CONTROL PANEL

P11 (x1)  
LEFT WALL PANEL

**P11 SITS AGAINST TRIM AND CLEAT ON FLOOR PANEL AS SHOWN.**

**FRONT OF P11 IS FLUSH WITH FRONT OF FLOOR PANEL.**

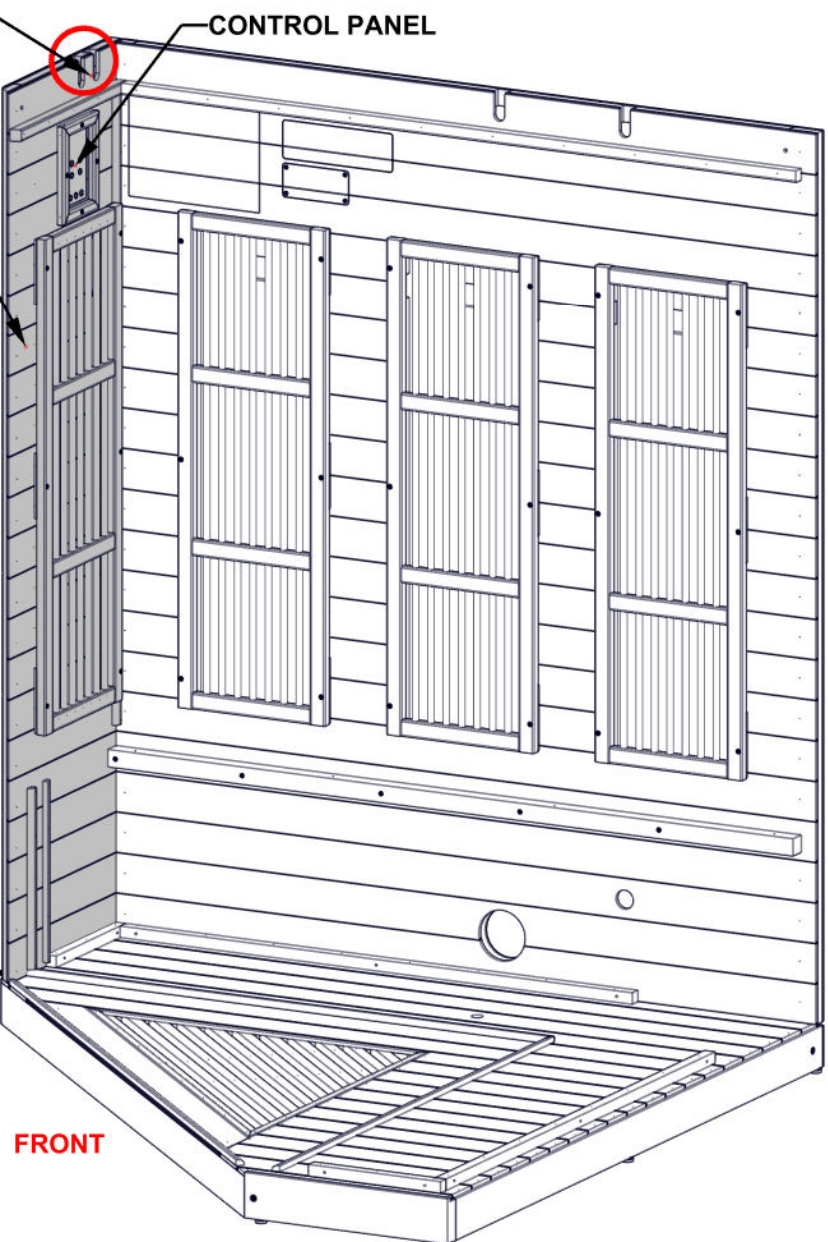

FRONT

# STEP 4 - SAUNA ASSEMBLY

- ALIGN THROUGH HOLES IN LEFT WALL PANEL WITH THREADED INSERTS IN BACK WALL PANEL.
- INSERT HARDWARE AS SHOWN.
- **HAND TIGHTEN ONLY.**

Qty	PartNo	Description
4	H100406	BOLT WH 1/4x1 1/2 BLK LT
4	H100405	WASHER LOCK EXT 6x15

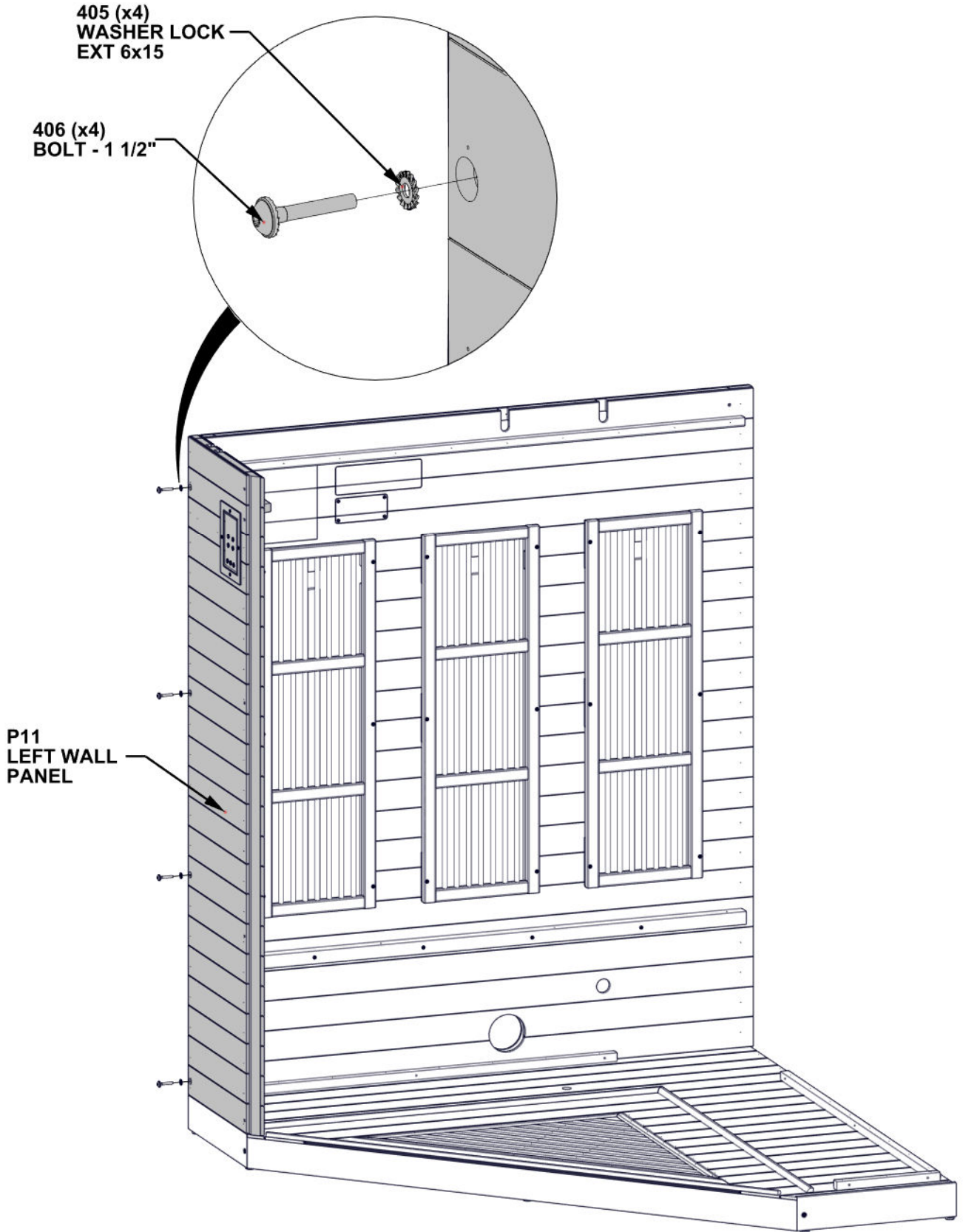

# STEP 5 - SAUNA ASSEMBLY

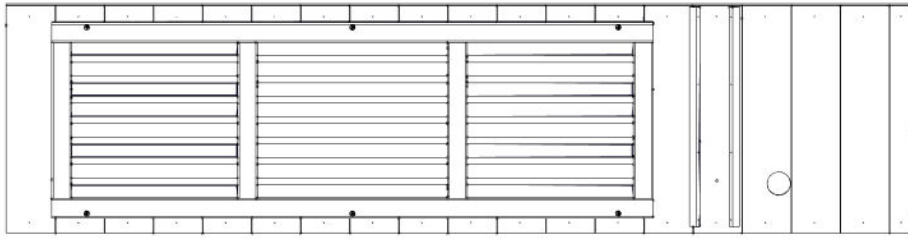

P05 SEAT SUPPORT PANEL LEFT - W2A04897  
(x1) 2 11/16"x15 3/8"x61 3/16" (69x390x1554)

- TO INSTALL P05, INSERT AT AN ANGLE AS SHOWN.
- ENSURE LEFT SIDE FITS BETWEEN THE TWO PIECES OF TRIM.
- ROTATE ASSEMBLY UNTIL THE PANEL RESTS AGAINST THE TRIM ON FLOOR PANEL.

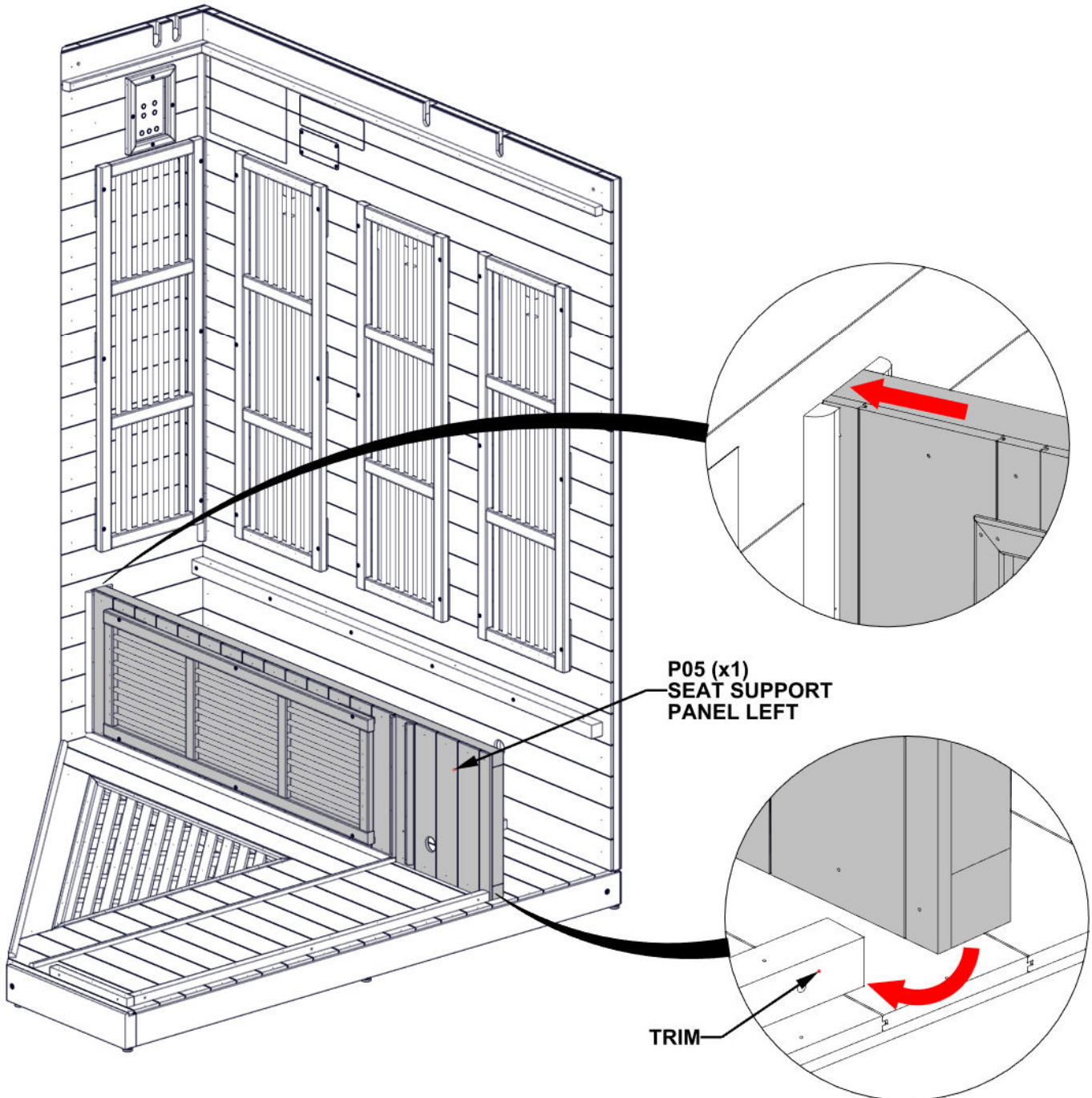

# STEP 6A - SAUNA ASSEMBLY

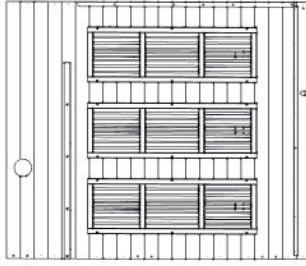

**P02 BACK WALL PANEL RIGHT - W2A04902**  
(x1) 2 11/16"x72 13/16"x61 3/8" (69x1850x1558)

- STAND UP P02 AND ORIENT AS SHOWN.
- BACK OF P02 WILL BE FLUSH WITH BACK OF P01 AND P03.
- ONE PERSON WILL HOLD UP AND SUPPORT P02 GOING TO THE NEXT STEP.

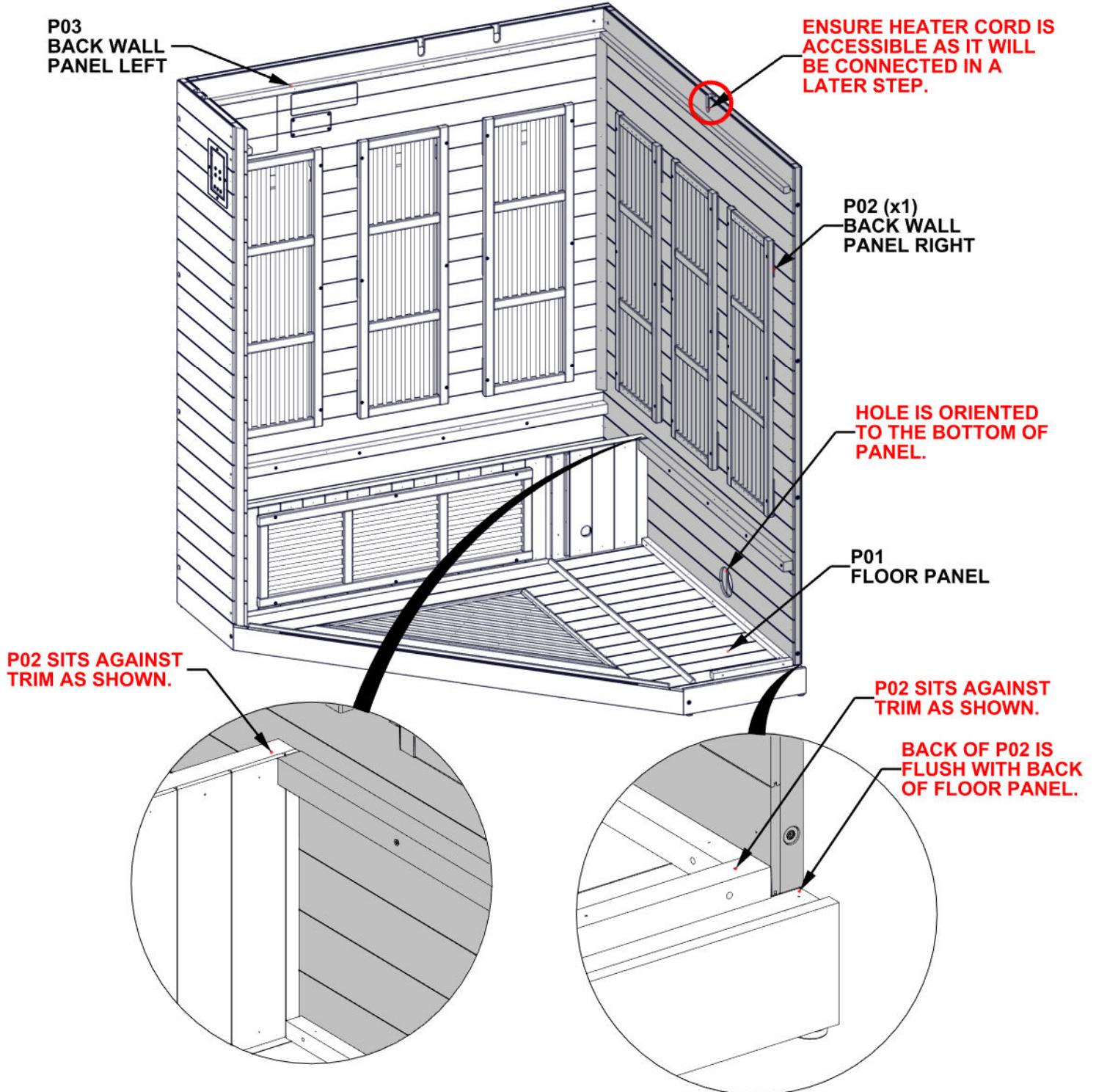

# STEP 6B - SAUNA ASSEMBLY

Qty	PartNo	Description
10	H101462	FLAT HEAD SCREW .25-20 x 1in



5906 CORNER BRACKET - A4M05906  
(x1) 3 5/8"x3 5/8"x76 9/16" (92x92x1944)

- ALIGN THROUGH HOLES IN CORNER BRACKET WITH THREADED INSERTS IN BACK WALL PANELS.
- INSERT HARDWARE AS SHOWN.
- **HAND TIGHTEN ONLY.**

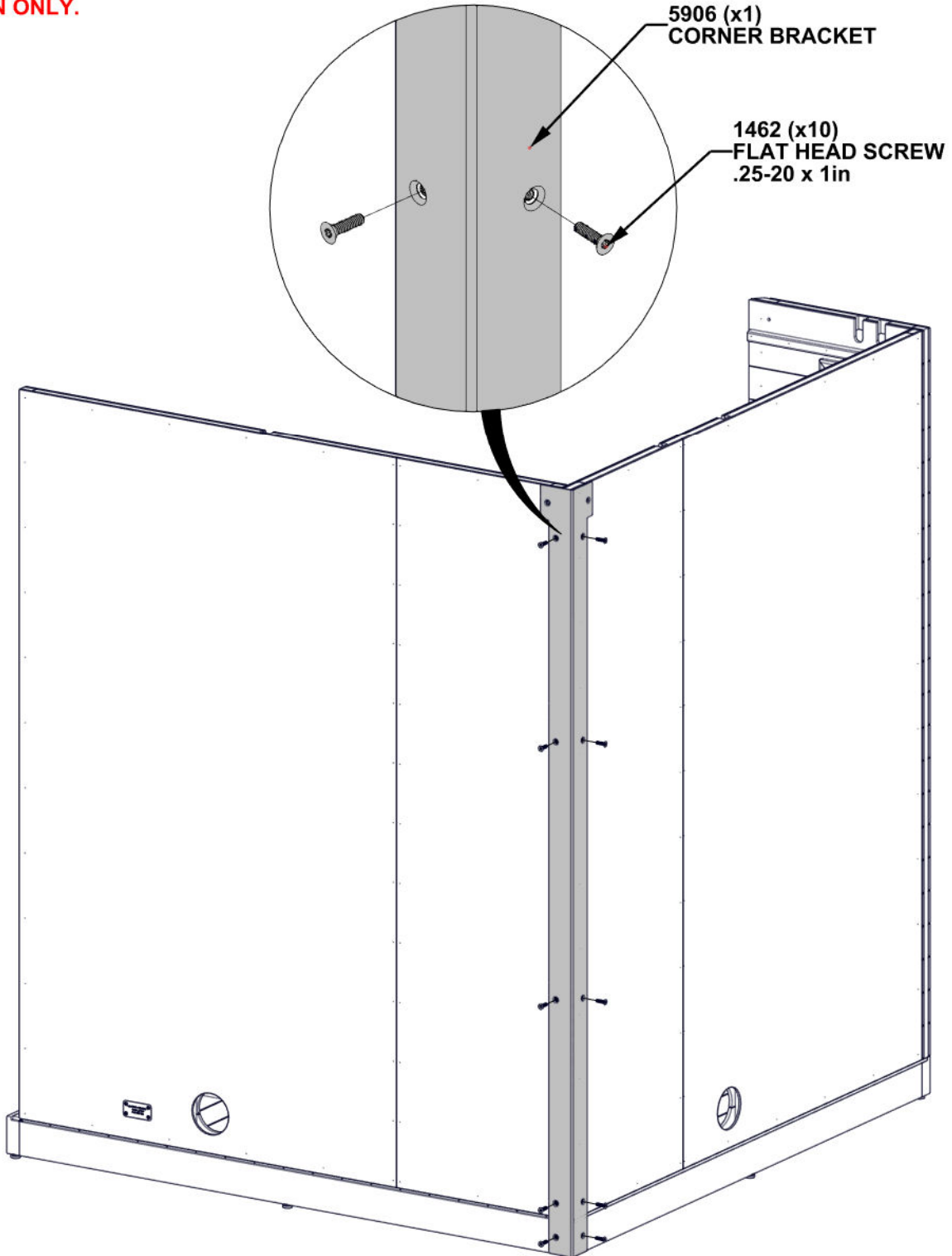

# STEP 7 - SAUNA ASSEMBLY

Qty	PartNo	Description
1	H100385	SCREW PFH 8x1 BLK

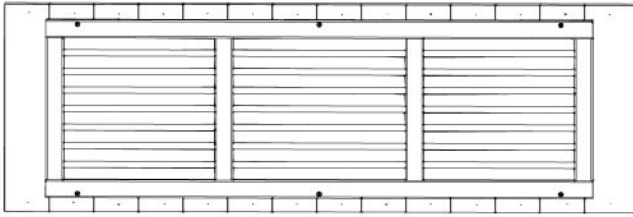

**P04 SEAT SUPPORT PANEL RIGHT - W2A04898**  
(x1) 2 11/16"x15 3/8"x46 3/4" (69x390x1187)

- TO INSTALL P04, INSERT AT AN ANGLE AS SHOWN.
- ENSURE LEFT SIDE FITS BETWEEN THE TWO PIECES OF TRIM.
- ROTATE ASSEMBLY UNTIL THE PANEL RESTS AGAINST THE TRIM ON FLOOR PANEL.

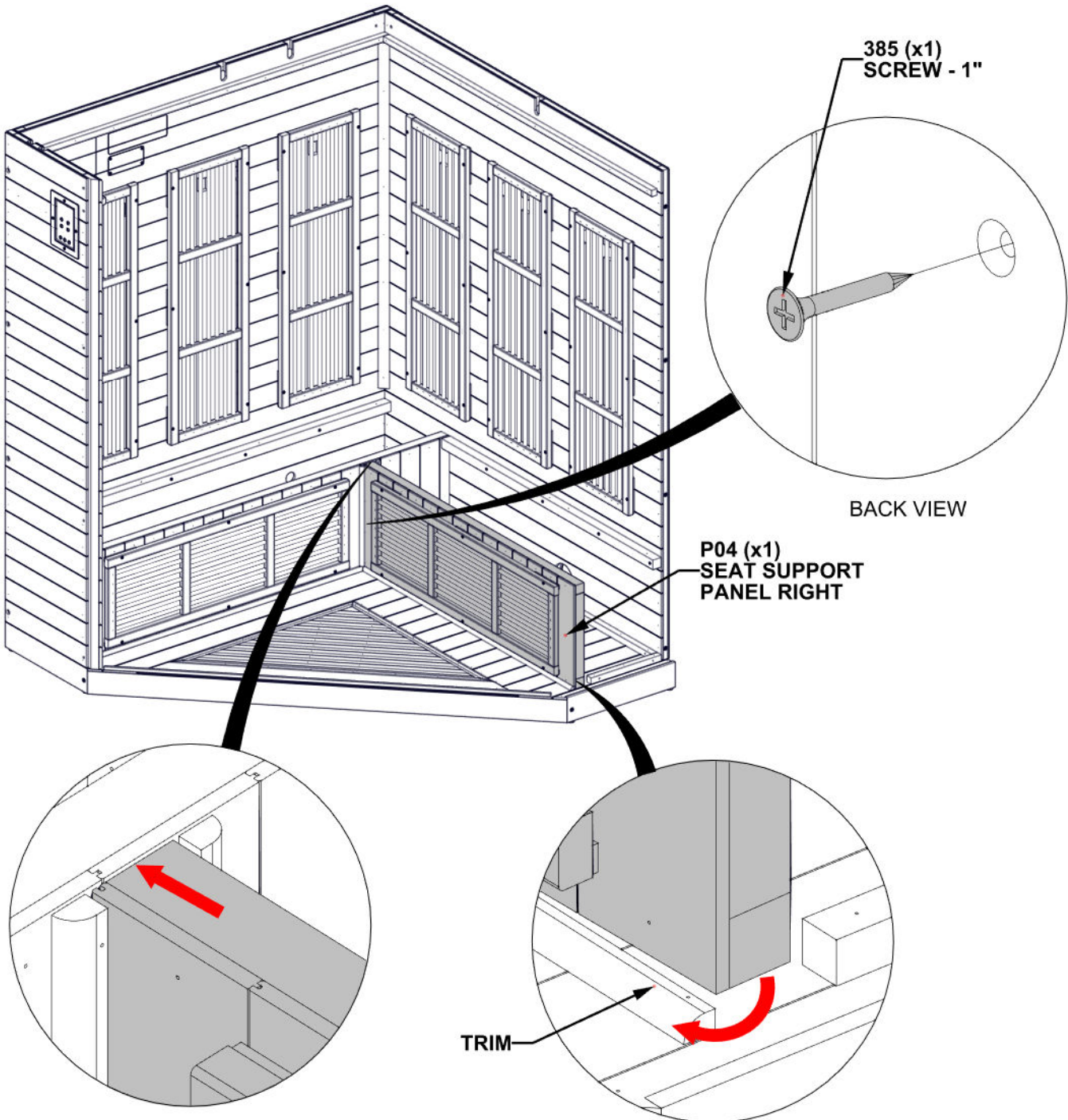

# STEP 8 - SAUNA ASSEMBLY

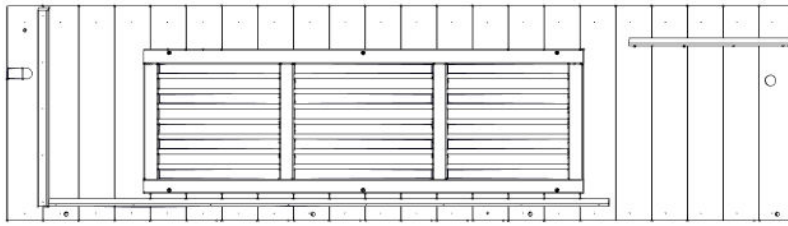

P10 RIGHT WALL PANEL - W2A04907  
(x1) 2 3/8"x19 5/8"x72 13/16" (61x499x1850)

- STAND UP P10 AND ORIENT AS SHOWN.
- KEEP P10 SUPPORTED UNTIL ATTACHED IN NEXT STEP.

**ENSURE HEATER CORD IS ACCESSIBLE AS IT WILL BE CONNECTED IN A LATER STEP.**

P10 (x1)  
RIGHT WALL PANEL

TRIM IS ORIENTED TO THE BOTTOM AS SHOWN.

**P10 SITS AGAINST TRIM AS SHOWN.**

**FRONT**

**FRONT OF P10 IS FLUSH WITH FRONT OF FLOOR PANEL.**

# STEP 9 - SAUNA ASSEMBLY

- ALIGN THROUGH HOLES IN RIGHT WALL PANEL WITH THREADED INSERTS IN BACK WALL PANEL.
- INSERT HARDWARE AS SHOWN.
- **HAND TIGHTEN ONLY.**

Qty	PartNo	Description
4	H100406	BOLT WH 1/4x1 1/2 BLK LT
4	H100405	WASHER LOCK EXT 6x15

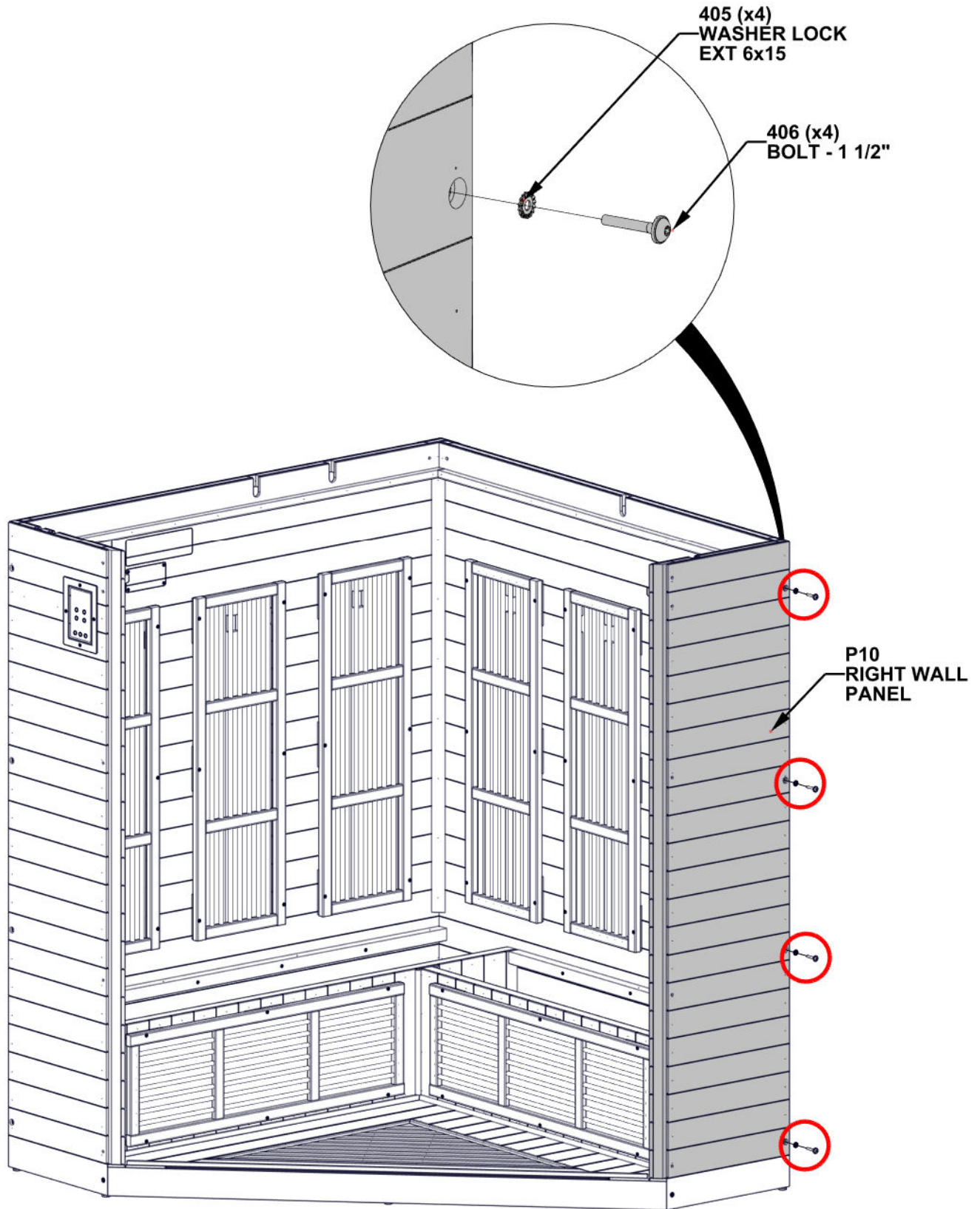

# STEP 10 - SAUNA ASSEMBLY

Qty	PartNo	Description
10	H100382	SCREW PFH 8x1 3/4 BLK

- ENSURE WALL PANELS ARE PRESSED FIRMLY AGAINST TRIM AND CLEATS ON THE INSIDE.
- ENSURE OUTSIDE OF EACH WALL PANEL IS FLUSH WITH OUTSIDE OF FLOOR PANEL.
- ATTACH WITH SCREWS AS SHOWN.

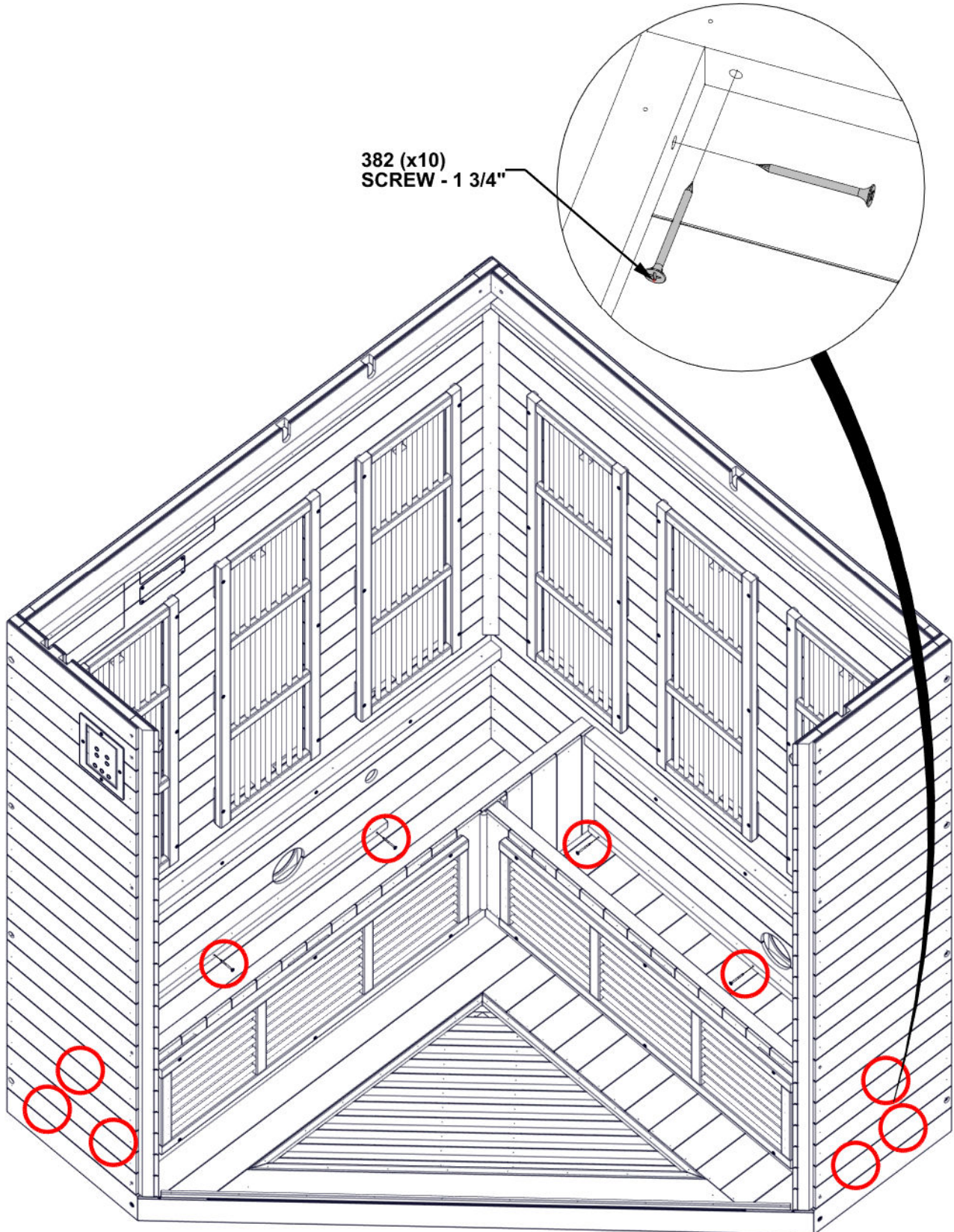

# STEP 11 - SAUNA ASSEMBLY

CONNECT POWER CORDS FROM SEAT SUPPORT PANEL TO POWER CORDS IN BACK WALL PANEL AND FLOOR PANEL AS SHOWN.

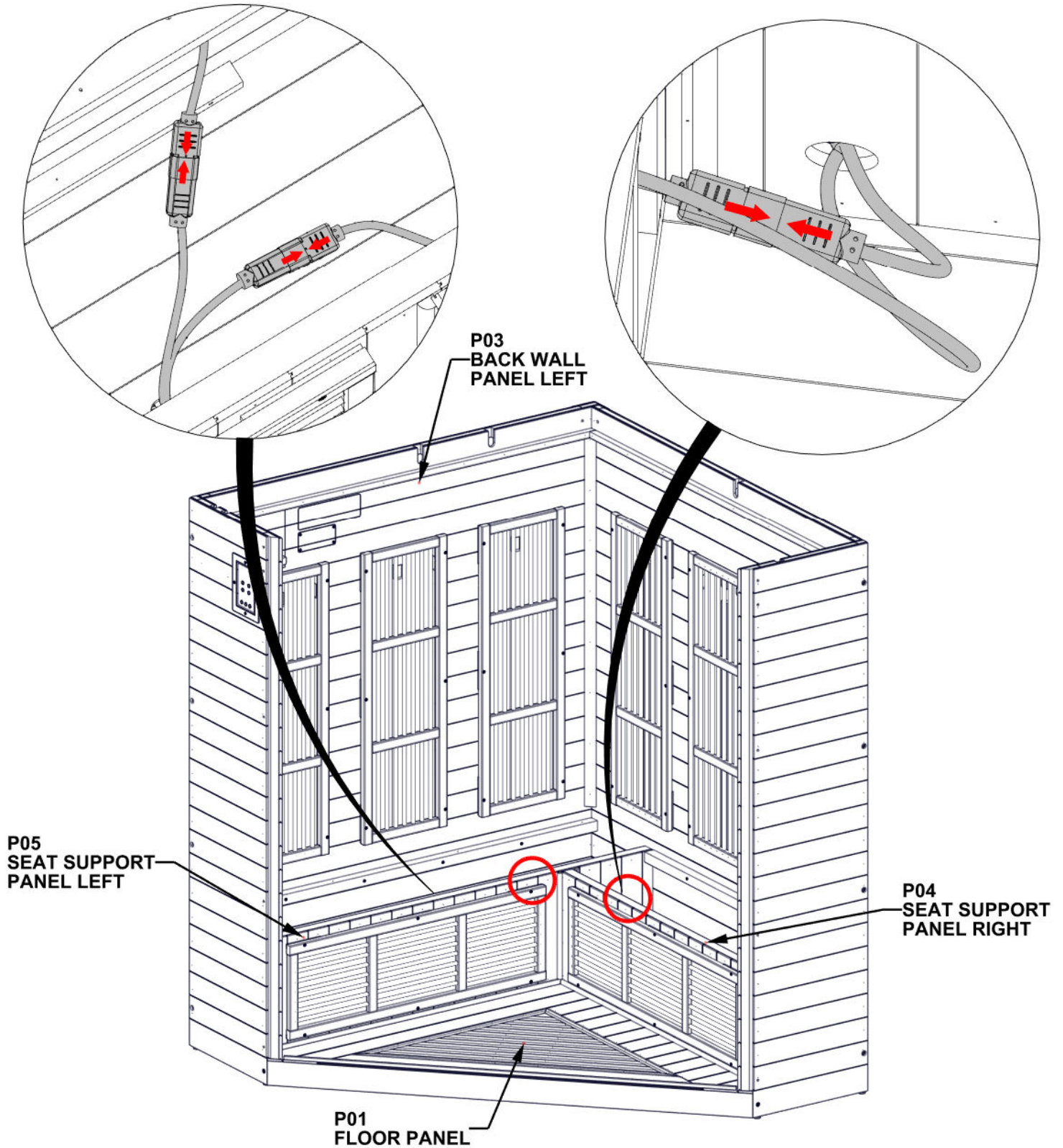

# STEP 12A - SAUNA ASSEMBLY

Qty	PartNo	Description
8	H100201	SCREW PFH 8x2 1/2 BLK

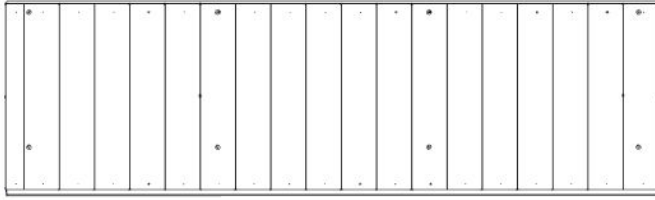

**P06 SEAT PANEL - W2A04900**  
(x1) 61 1/4"x18 3/16"x1 3/4" (44x461x1556)

- SLIDE P06 INTO PLACE AS SHOWN.
- ENSURE BACK SIDE OF P06 IS AGAINST BACK WALL BEFORE ATTACHING.
- ENSURE P05 IS STILL IN THE CORRECT POSITON AND WAS NOT MOVED WHEN SLIDING IN SEAT PANEL.
- ATTACH WITH SCREWS AS SHOWN.

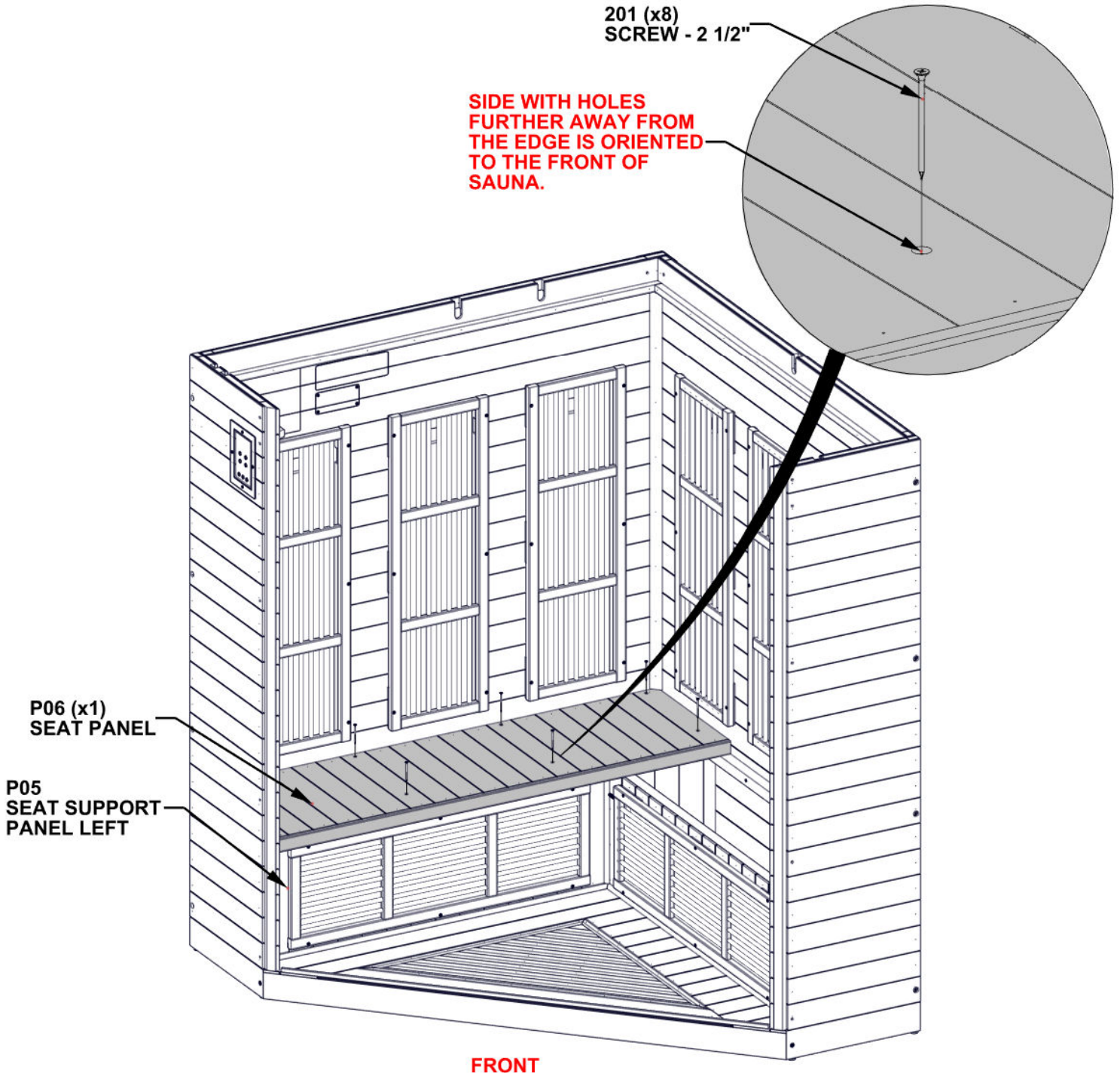

# STEP 12B - SAUNA ASSEMBLY

Qty	PartNo	Description
7	H100201	SCREW PFH 8x2 1/2 BLK

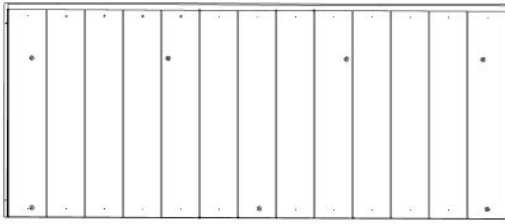

**P09 SEAT PANEL - W2A04899**  
 (x1) 1 3/4"x18 3/16"x43 1/8" (44x461x1095)

- SLIDE P09 INTO PLACE AS SHOWN.
- ENSURE BACK SIDE OF P09 IS AGAINST BACK WALL BEFORE ATTACHING.
- ENSURE P04 IS STILL IN THE CORRECT POSITON AND WAS NOT MOVED WHEN SLIDING IN SEAT PANEL.
- ATTACH WITH SCREWS AS SHOWN.

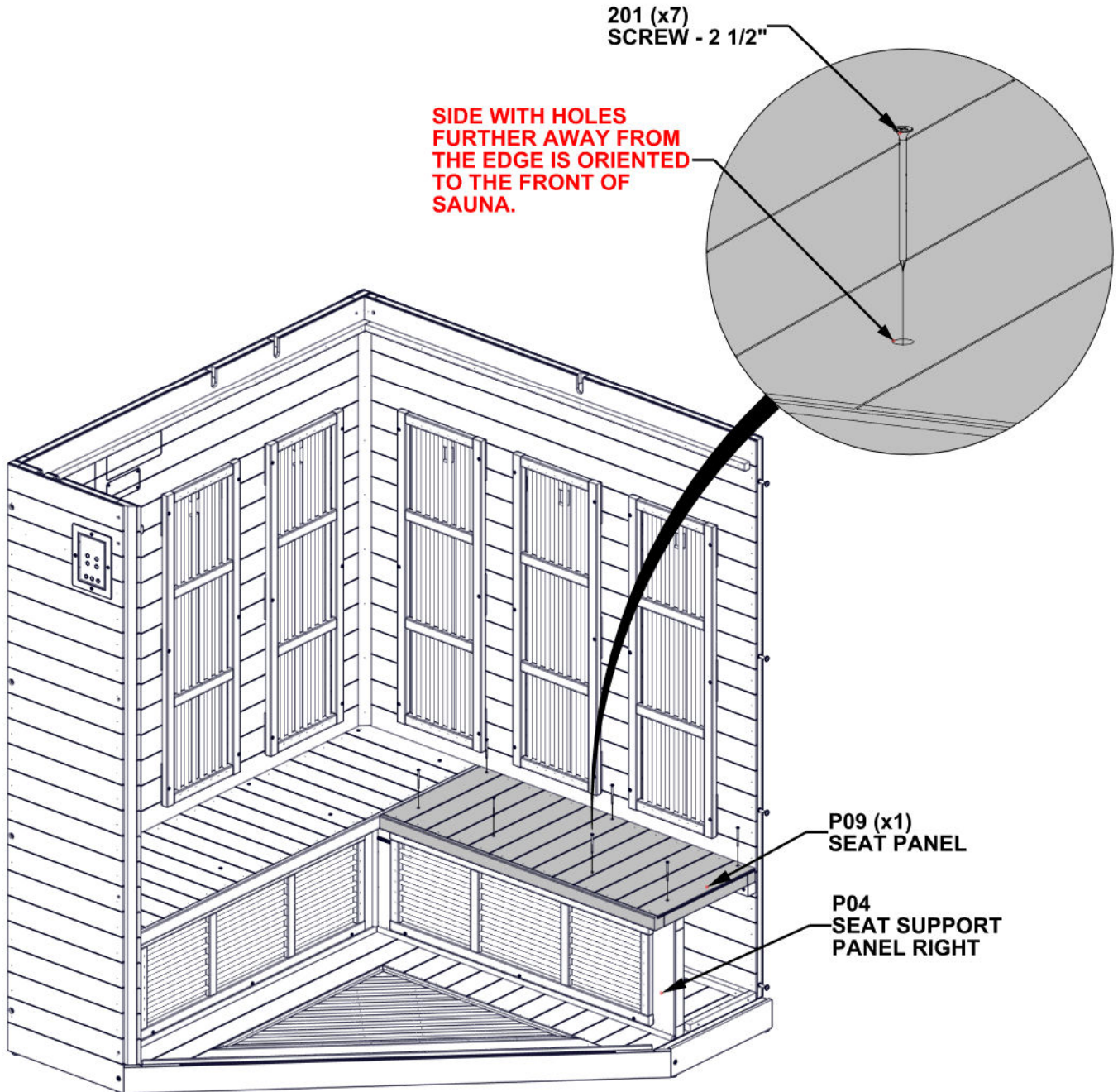

**FRONT**

SIDE WALL HIDDEN TO SHOW  
 DETAIL: DO NOT REMOVE  
 WALL PANEL.

# STEP 13 - SAUNA ASSEMBLY

Qty	PartNo	Description
10	H101462	FLAT HEAD SCREW .25-20 x 1in
28	H100385	SCREW PFH 8x1 BLK

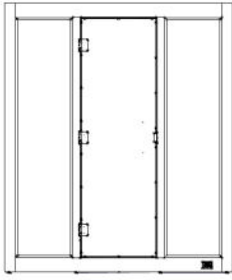

P07 DOOR PANEL - W2A04904  
(x1) 1 3/8"x65"x76 1/2" (36x1652x1944)



6588 DOOR BRACKET - A4M06588  
(x2) 1 1/8"x2 11/16"x76 9/16" (29x68x1944)

- ORIENT P07 AS SHOWN.
- ENSURE SIDES OF P07 ARE FLUSH WITH RIGHT AND LEFT WALL PANELS.
- ALIGN THROUGH HOLES IN DOOR BRACKETS WITH HOLES IN SIDE WALL PANELS AND FRONT PANEL.
- INSERT HARDWARE AS SHOWN.
- FULLY TIGHTEN ALL CORNER BOLTS AFTER FRONT SCREWS ARE ATTACHED.
- CAUTION: DOOR PANEL INSTALLATION REQUIRES TWO PEOPLE.
- CAUTION: SUPPORT GLASS DOOR AT ALL TIMES DURING INSTALL TO PREVENT ACCIDENTAL OPENING AND BREAKAGE.

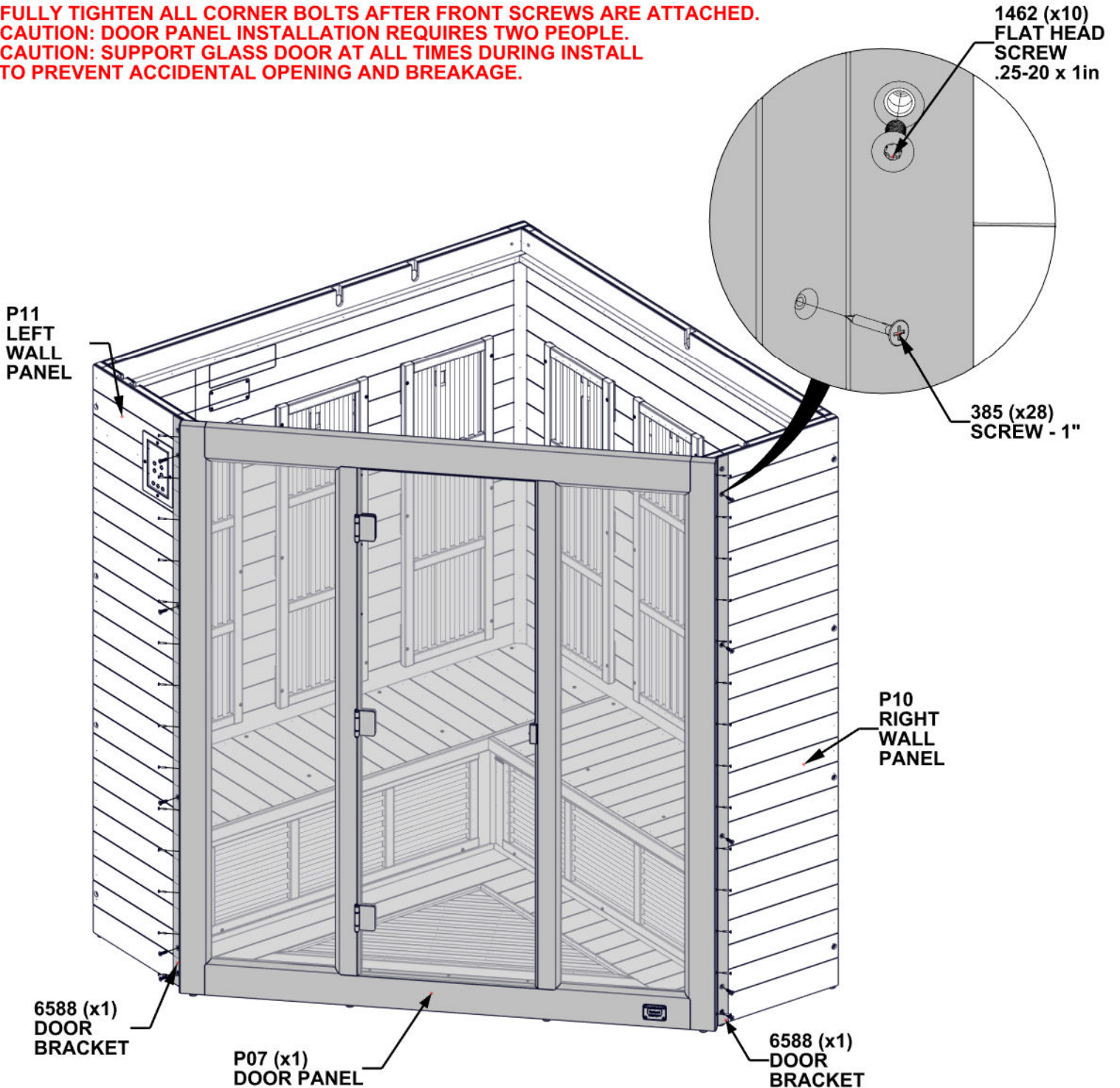

# STEP 14 - SAUNA ASSEMBLY

Qty	PartNo	Description
2	H101450	BOLT WH 1/4x1 1/2 BLK LT
2	H100405	WASHER LOCK EXT 6x15
4	H101403	POLY WASHER



OO01 HANDLE BAR - W4L21815  
(x1) 1 3/16"x1 3/16"x11 15/16" (30x30x304)

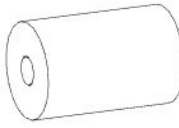

HS01 HANDLE STANDOFF - W4L21813  
(x2) 15/16"x1 5/8" (x24x42)

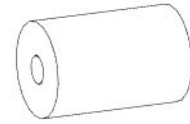

HS02 HANDLE STANDOFF - W4L21814  
(x2) 15/16"x1 5/8" (x24x42)



H01 HANDLE ASSEMBLY - W2A04763  
(x1) 1 3/16"x1 3/16"x11 15/16" (30x30x304)

- ATTACH HANDLES AS SHOWN.  
- DO NOT OVERTIGHTEN.

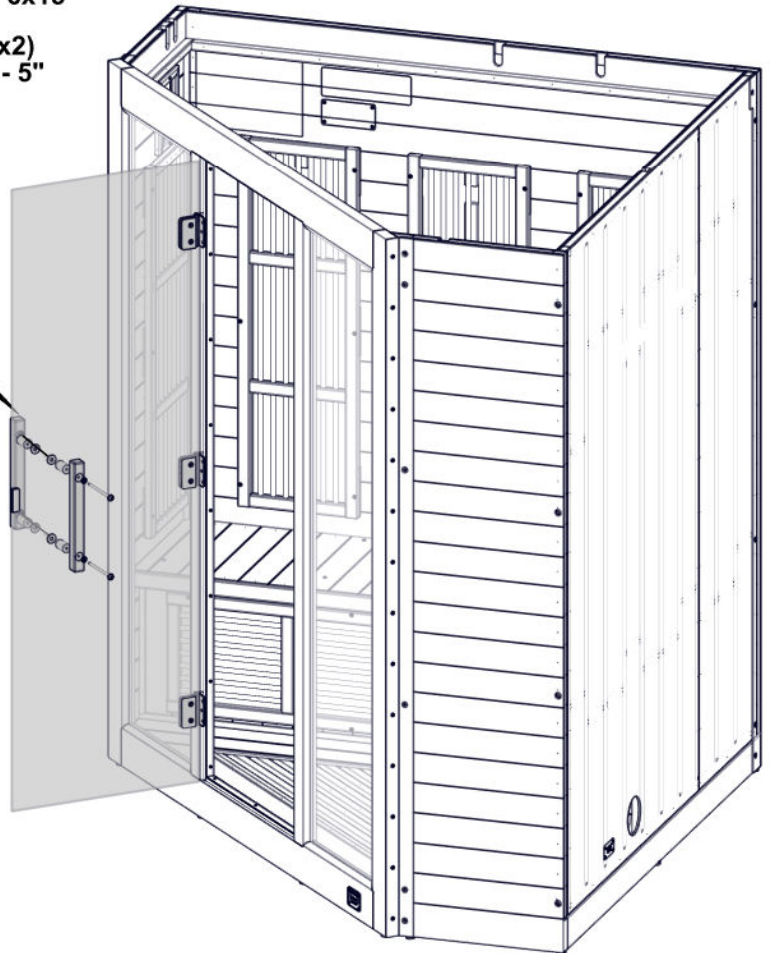
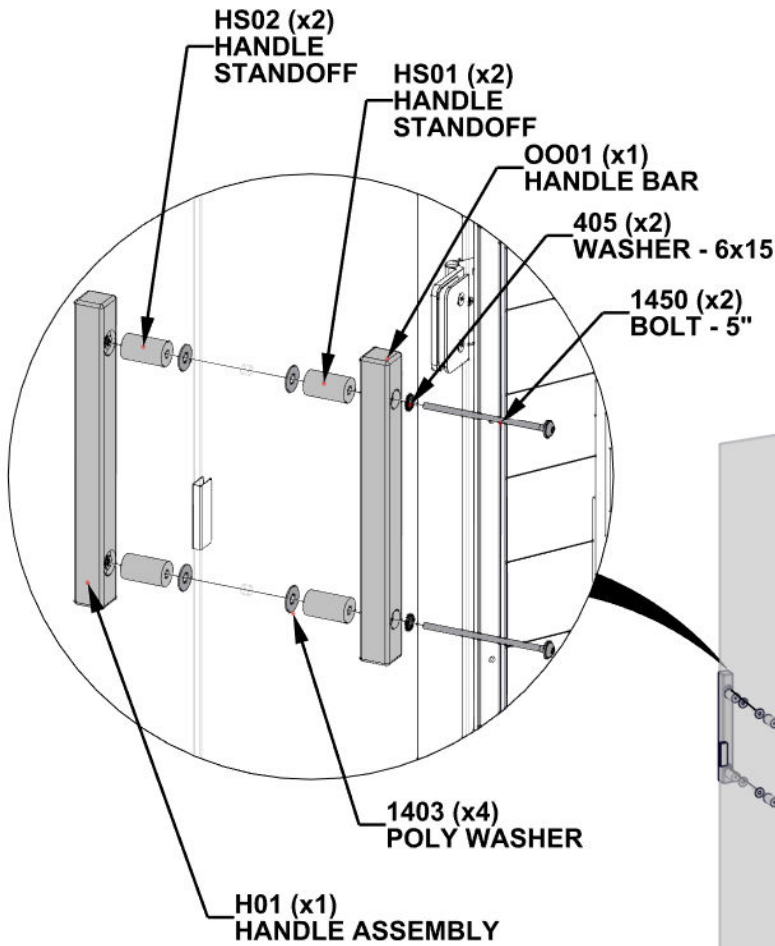

ENSURE HANDLE ASSEMBLY AND HANDLE STANDOFFS WITH DARKER STAIN GO ON THE OUTSIDE OF GLASS DOOR.

# STEP 15A - SAUNA ASSEMBLY

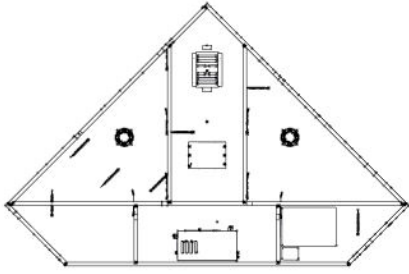

Qty	PartNo	Description
4	H101463	FLAT HEAD 1/4-20x2in

P08 ROOF PANEL - W2A04903  
(x1) 56 1/8"x86 3/8"x56 1/8" (70x2194x1425)

- LOWER ROOF PANEL INTO PLACE ORIENTED AS SHOWN UNTIL IT RESTS ON TRIM INSIDE SAUNA.
- INSERT SCREWS AT CORNERS TO ATTACH ROOF PANEL AS SHOWN.

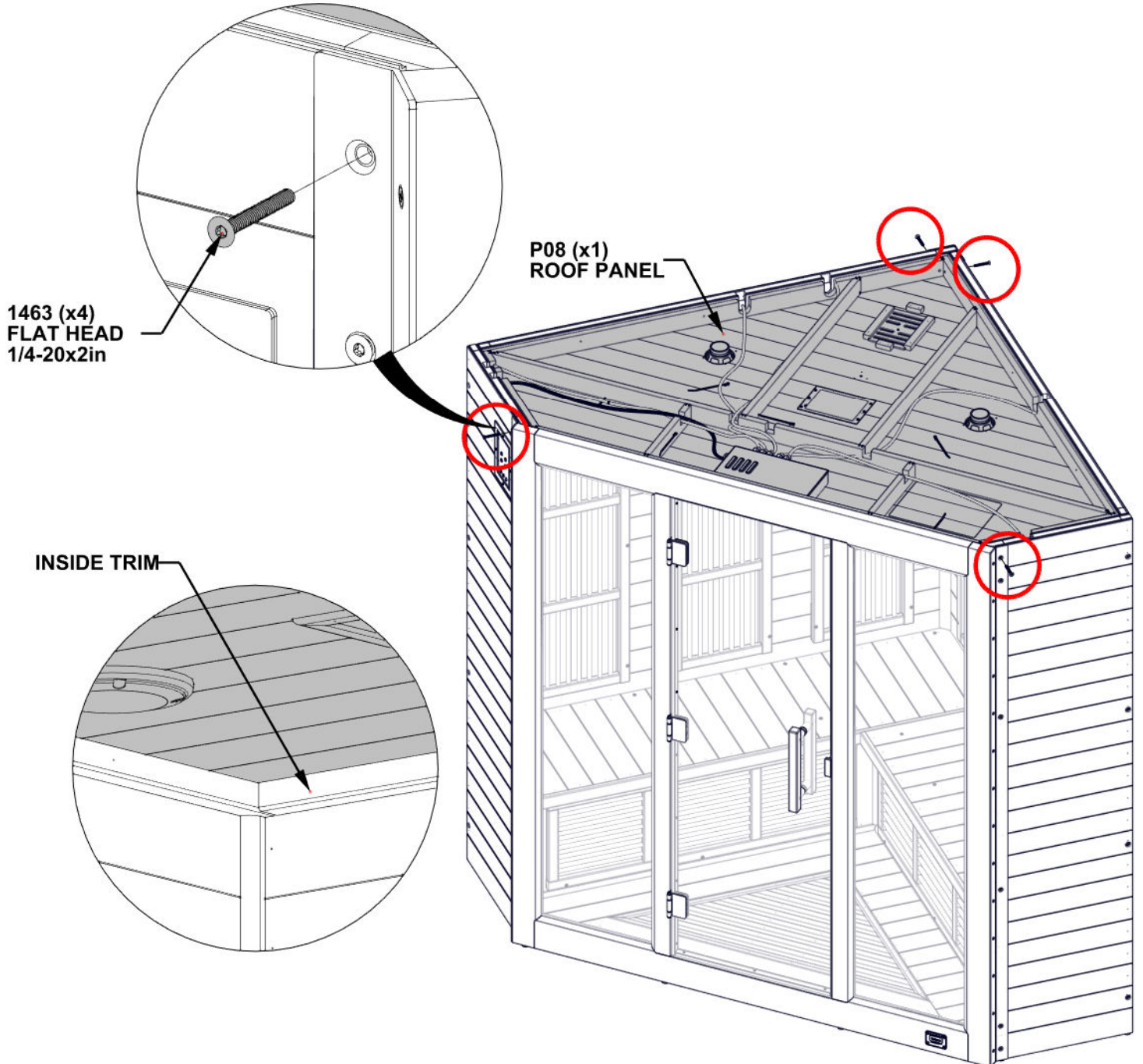

# STEP 15B - SAUNA ASSEMBLY

Qty	PartNo	Description
6	H100382	SCREW PFH 8x1 3/4 BLK

- INSERT SCREWS AT TOP TO ATTACH ROOF PANEL AS SHOWN.

**CAREFULLY TO ENSURE CABLES ARE NOT PINCHED BETWEEN WALL PANELS AND ROOF PANEL.**

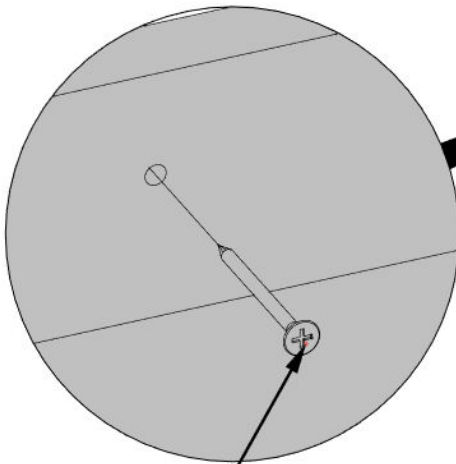
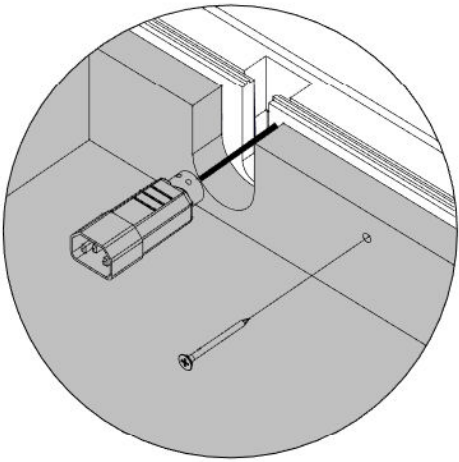

382 (x6)  
SCREW - 1 3/4"

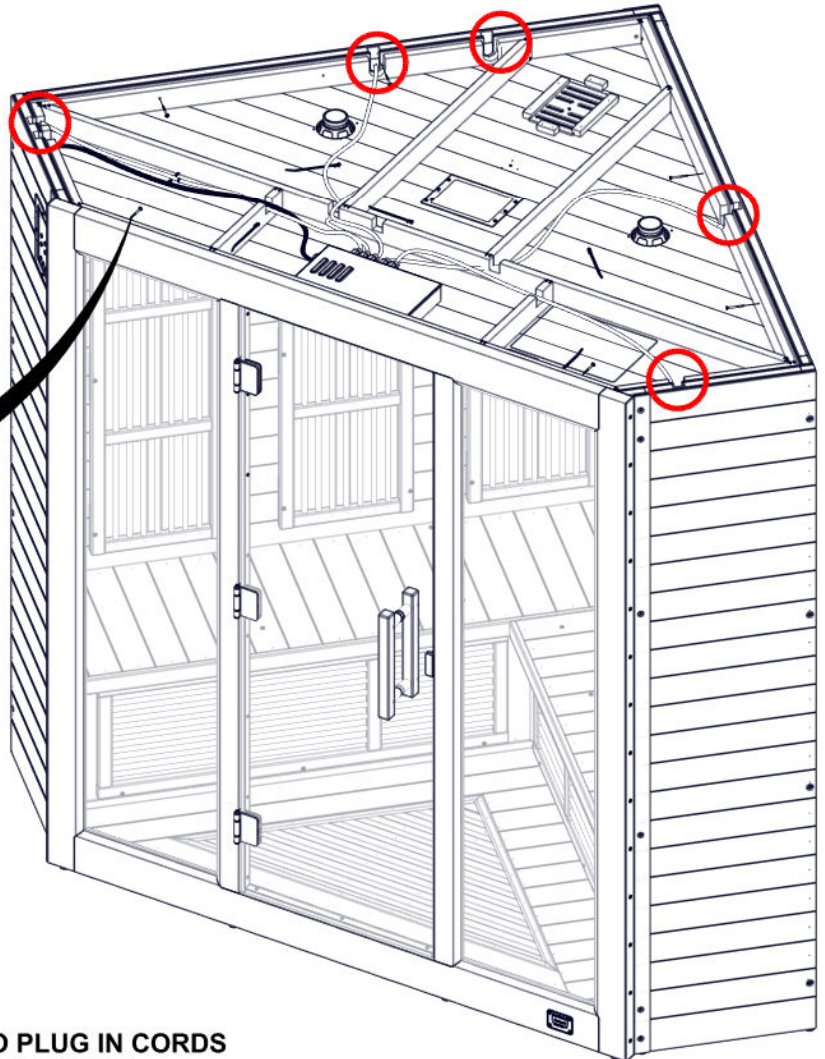

**WAIT TO PLUG IN CORDS UNTIL NEXT STEP.**

# STEP 16 - SAUNA ASSEMBLY

- CONNECT POWER CORDS FROM SIDE AND BACK WALLS TO THE CONTROLLER AS SHOWN.
- ENSURE POWER CORDS ARE RUN THROUGH NOTCHES IN THE ROOF PANEL.
- **IMPORTANT: IF THE TEMP SENSOR IS NOT INSTALLED CORRECTLY, THE SAUNA WILL NOT HEAT UP PROPERLY.**

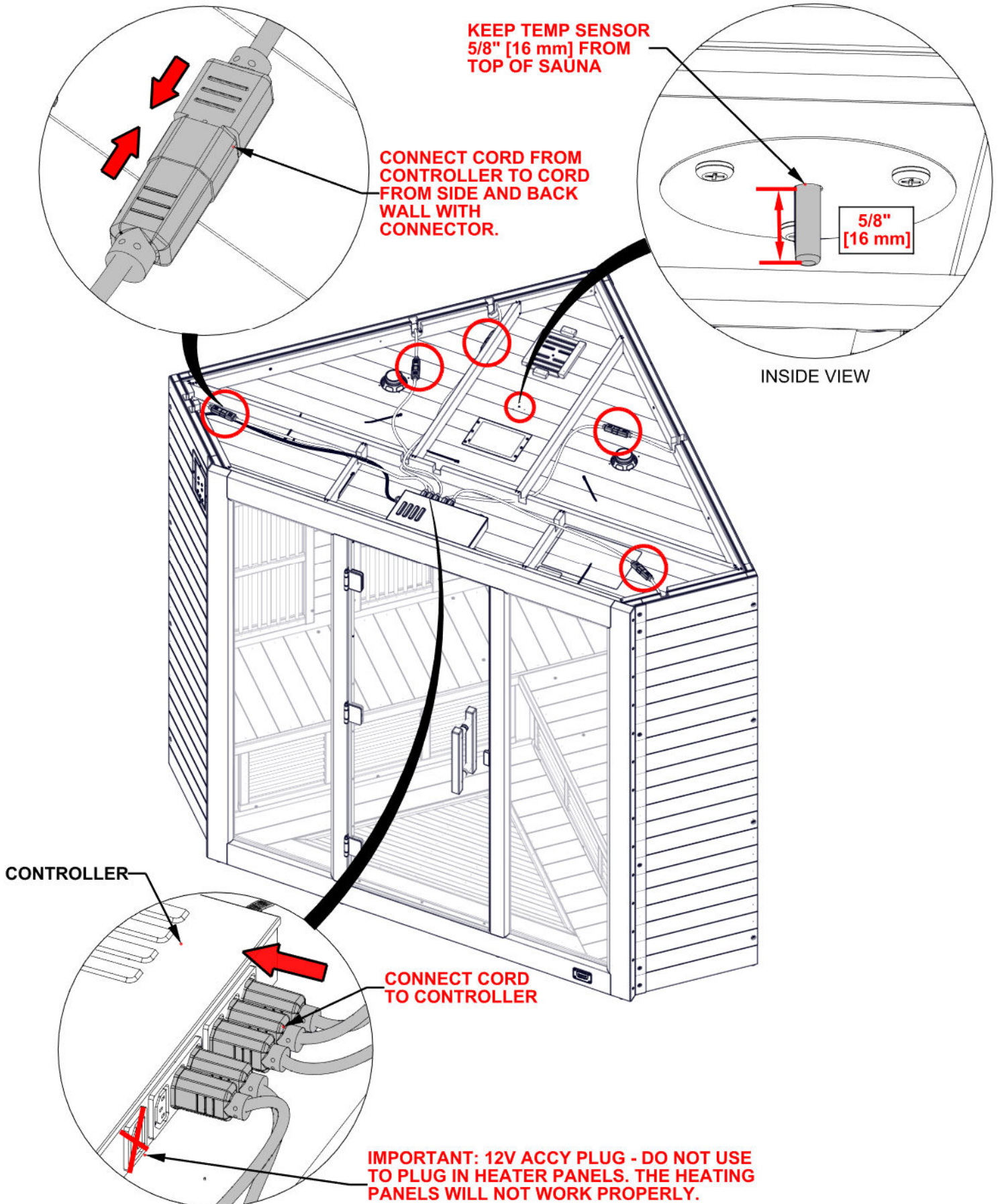

# STEP 17 - SAUNA ASSEMBLY

Qty	PartNo	Description
24	H100408	SCREW PWH 8x1/2 BLK



A4M05358 CORNER GUARD  
(x2)

- HOLD CORNER GUARD FLUSH WITH TOP OF BACK AND SIDE WALL PANELS AND ATTACH.

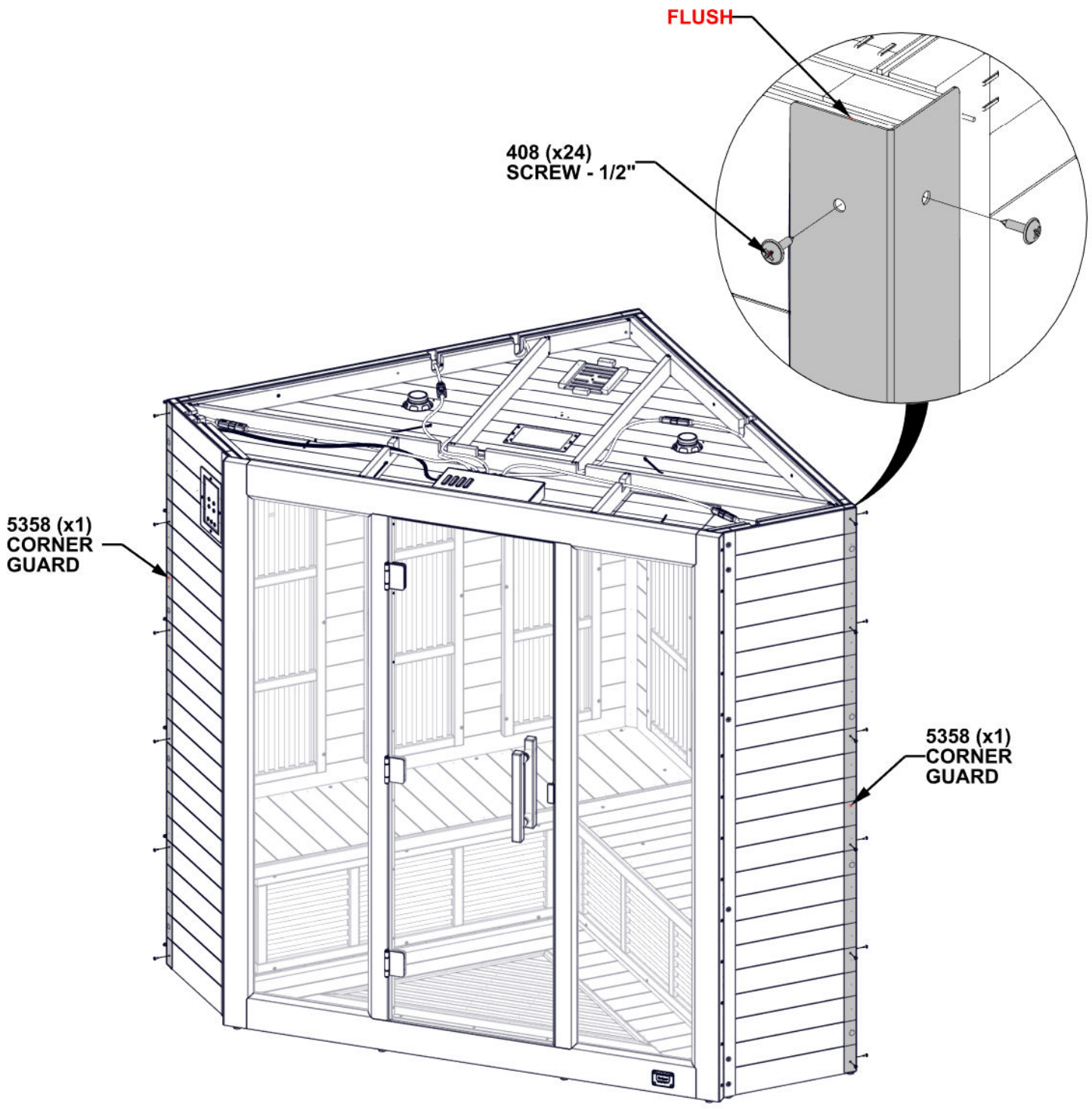

# STEP 18 - SAUNA ASSEMBLY

Qty	PartNo	Description
4	H100408	SCREW PWH 8x1/2 BLK

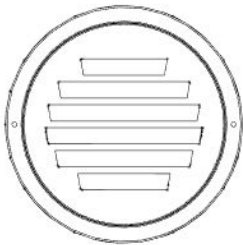

A4M05585 VENT  
(x2)

- INSERT VENTS INTO HOLES IN BACK OF SAUNA.
- ATTACH WITH SCREWS AS SHOWN.

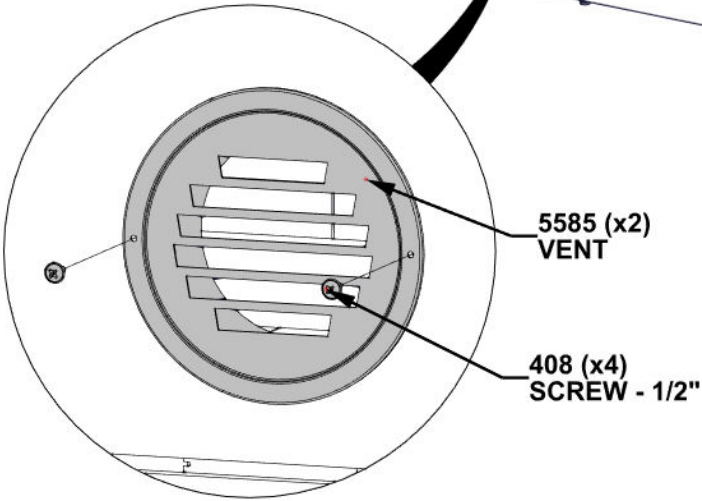
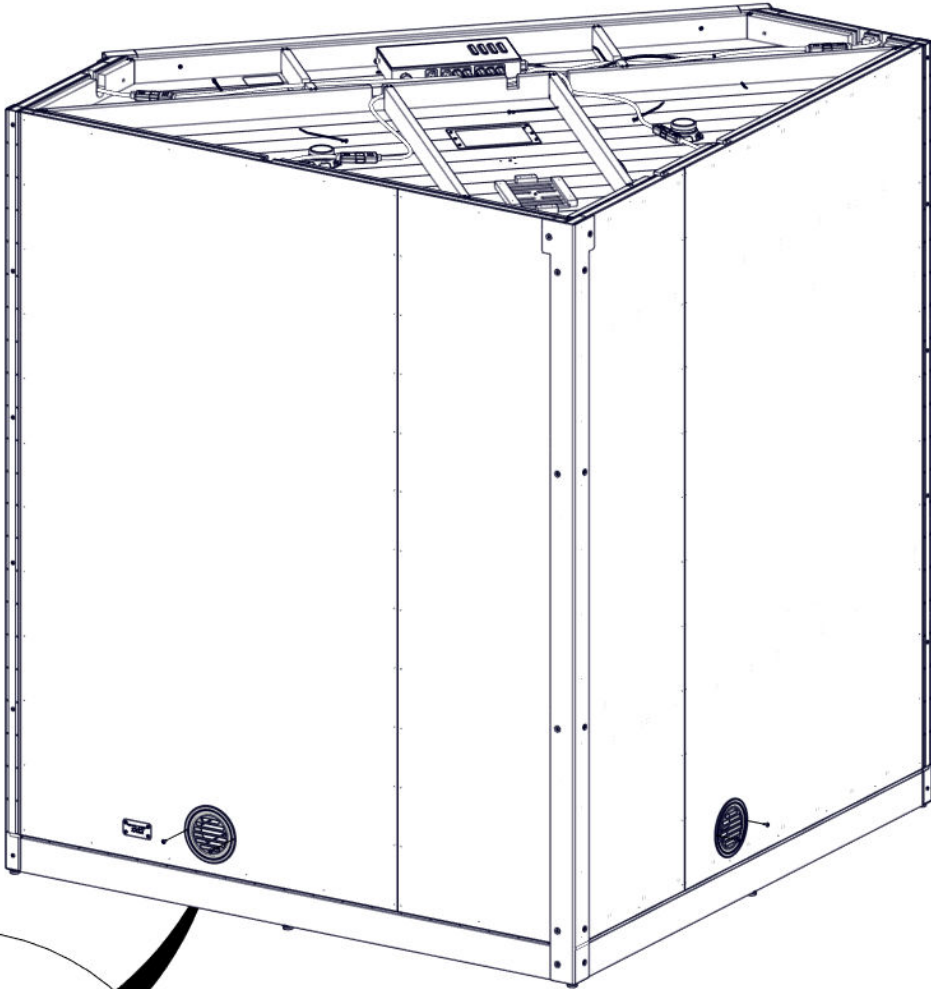

# STEP 19 - SAUNA ASSEMBLY

Qty	PartNo	Description
8	H101409	SCREW PPH 4x1/2 BLK

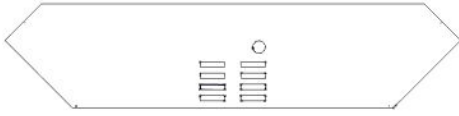

R01 ROOF COVER - W4L22339  
(x1) 3/16"x19 11/16"x86 1/2" (5x500x2198)

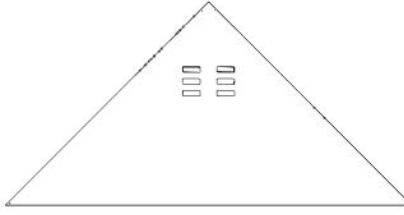

R02 ROOF COVER - W4L22340  
(x1) 3/16"x51 3/8"x72 11/16" (5x1305x1846)

- INSERT ROOF COVERS ORIENTED AS SHOWN.
- RUN POWER CORD THROUGH HOLE IN R01 AS SHOWN.
- ATTACH WITH SCREWS USING PILOT HOLES IN ROOF COVERS.

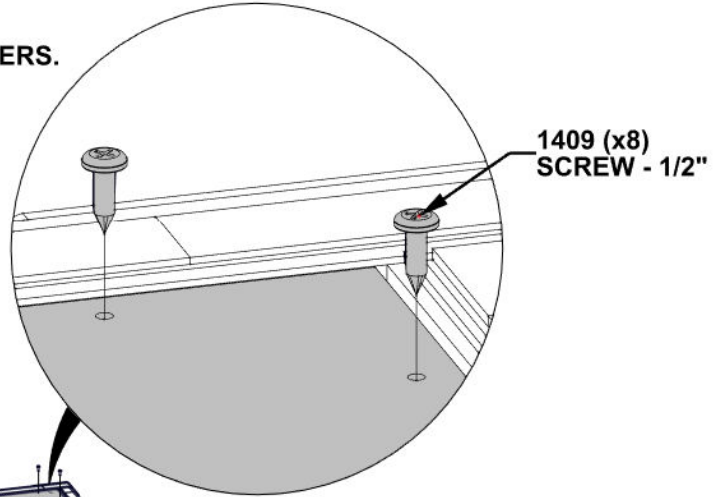

1409 (x8)  
SCREW - 1/2"

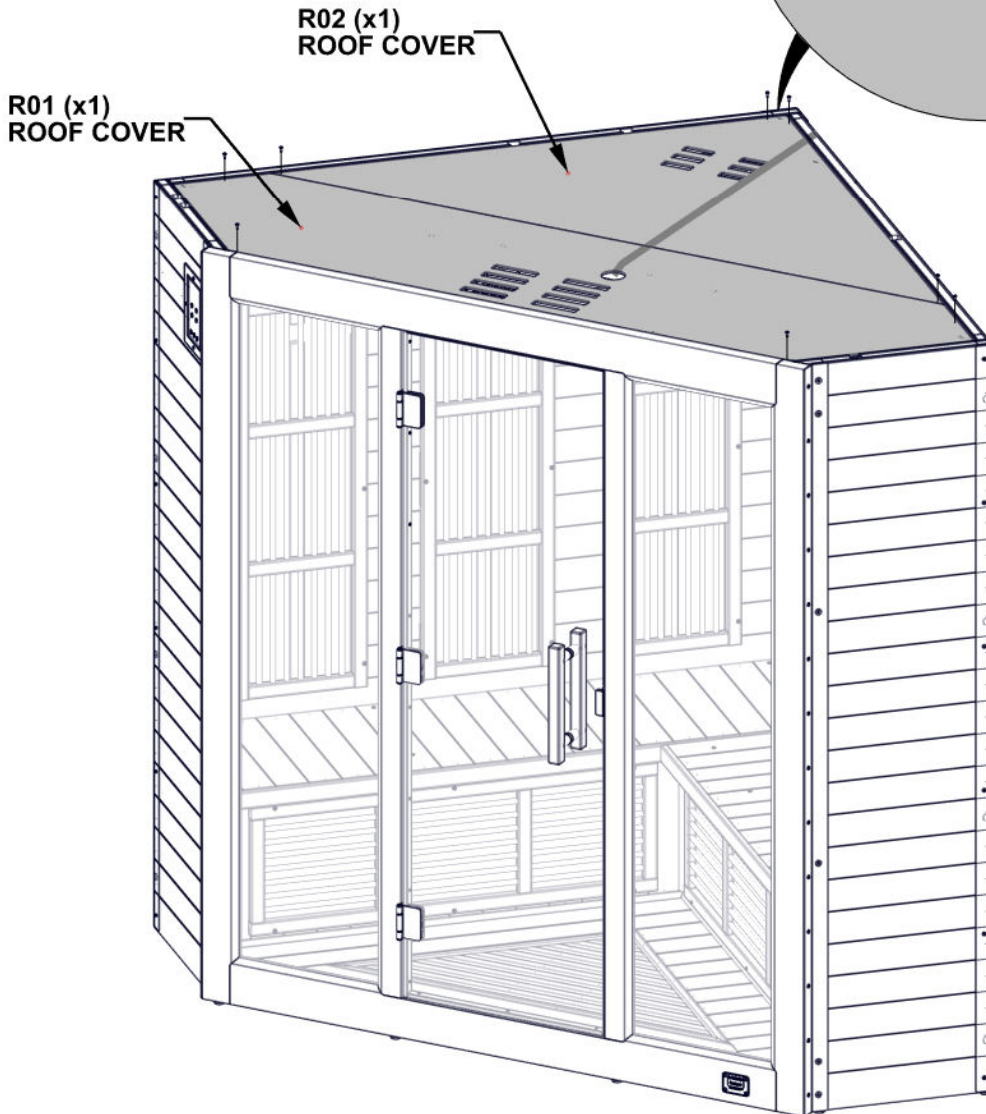

SEE OWNER'S MANUAL FOR OPERATING INSTRUCTIONS.