



## Air Gap Body with Cover K-9110

### Features

- Solid-brass cap offers years of reliable performance.
- Durable plastic body.
- KOHLER finishes resist corrosion and tarnishing.
- Includes valve body and cover.



### Codes/Standards











None Applicable

### KOHLER® Faucet Lifetime Limited Warranty

See website for detailed warranty information.

### Available Colors/Finishes

*Color tiles intended for reference only.*

Color	Code	Description
	CP	Polished Chrome
	SN	Vibrant® Polished Nickel
	PB	Vibrant® Polished Brass
	G	Brushed Chrome
	BN	Vibrant® Brushed Nickel
	VS	Vibrant® Stainless
	BV	Vibrant® Brushed Bronze
	2BZ	Oil-Rubbed Bronze
	BL	Matte Black
	VNT	Vintage Nickel

1-800-4KOHLER (1-800-456-4537)

Kohler Co. reserves the right to make revisions without notice to product specifications.

For the most current Specification Sheet, go to [www.kohler.com](http://www.kohler.com).

1-31-2019 17:41 - US/CA/MX

THE BOLD LOOK  
OF **KOHLER**®

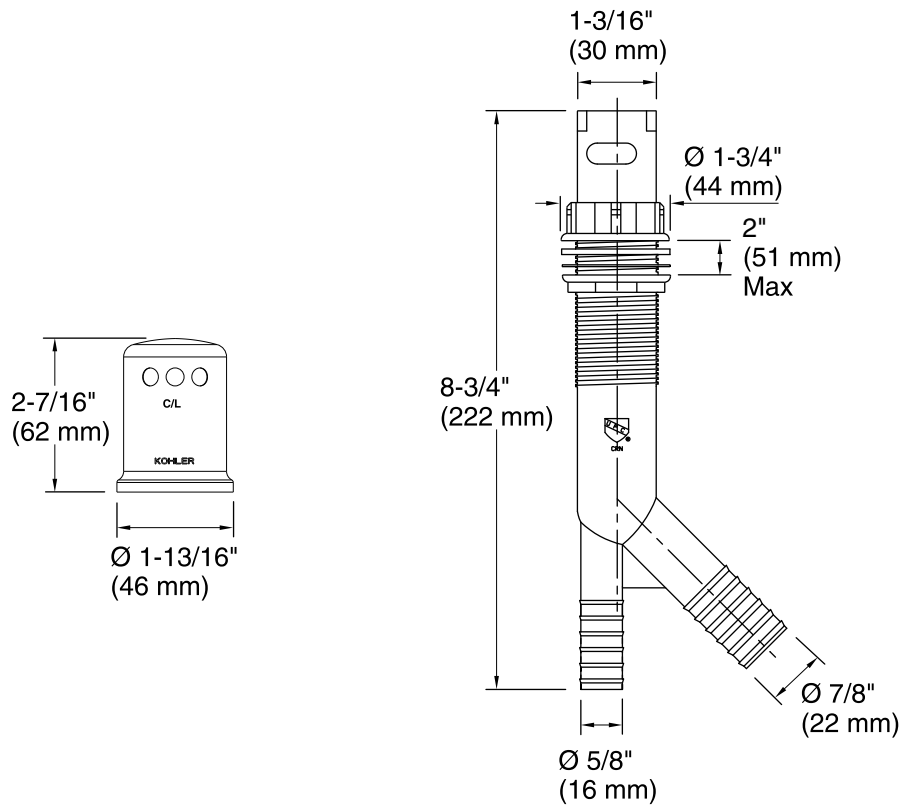

### Technical Information

All product dimensions are nominal.

### Notes

Install this product according to the installation guide.