







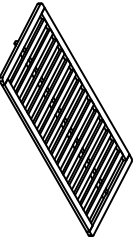
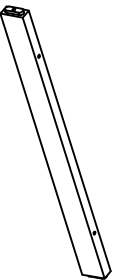

Part List and Hardware List

PIECE	DESCRIPTION	PICTURE	QUANTITY
1	Right Leg		1x
2	Left Leg		1x
3	Back Frame		1x
4	Seat Frame		1x
5	Tie Rod		1x
6	Back Cushion		2x
7	Seat Cushion		2x
Ⓐ	Screw 1	 M7x70 mm	2x
Ⓑ	Screw 2	 M6x60 mm	3x
Ⓒ	Screw 3	 M6x50 mm	7x
Ⓓ	Foot Cap		4x
Ⓔ	Allen Key	 M4	1x

JY

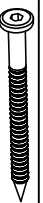
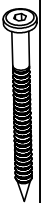
JONATHAN Y

MODEL# SFB1001

Product Dimension: 31" D x 54" W x 27" H

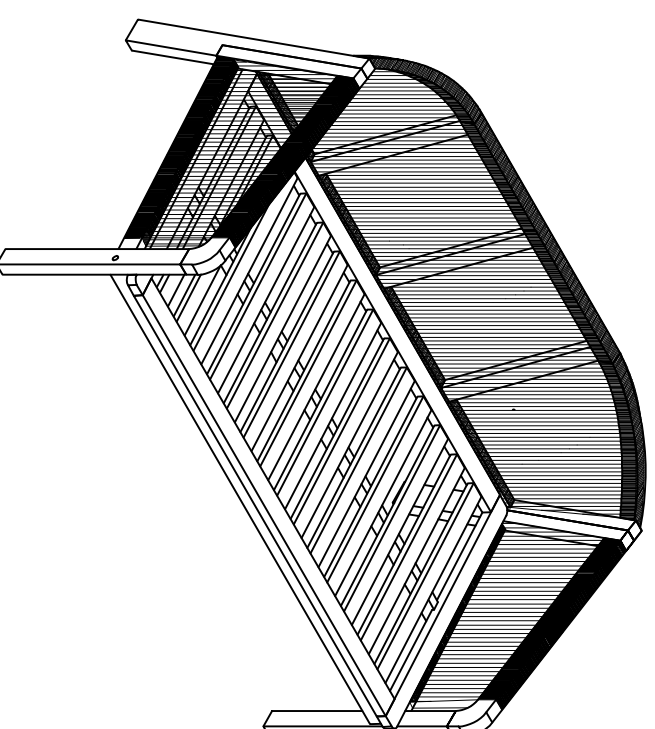

If there are any questions relating to defects, missing parts, assembly issues or replacements, please send a detailed email to cs@jonathany.com.

1

C	 M6x50 mm	4X
---	---	----

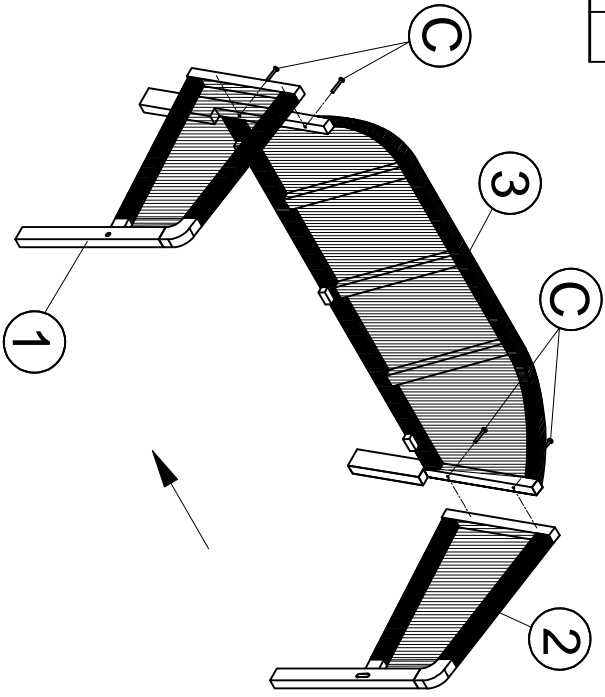

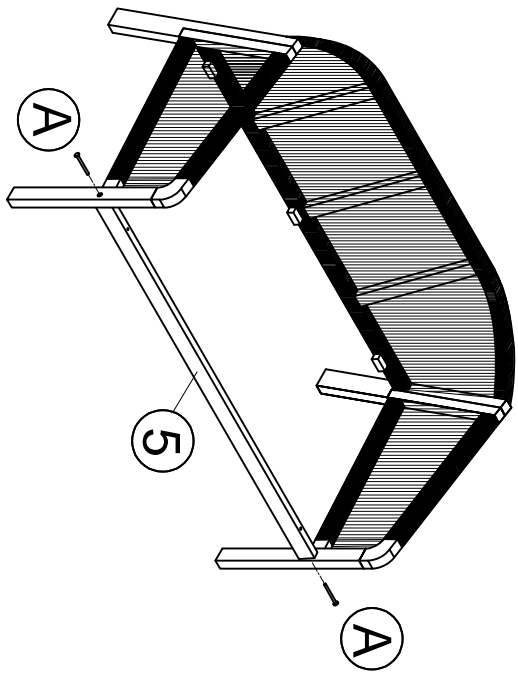

2

A	 M7x70 mm	2X
---	--	----

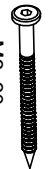
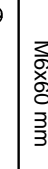

3

B	 M6x60 mm	3X
C	 M6x50 mm	3X
D		4X

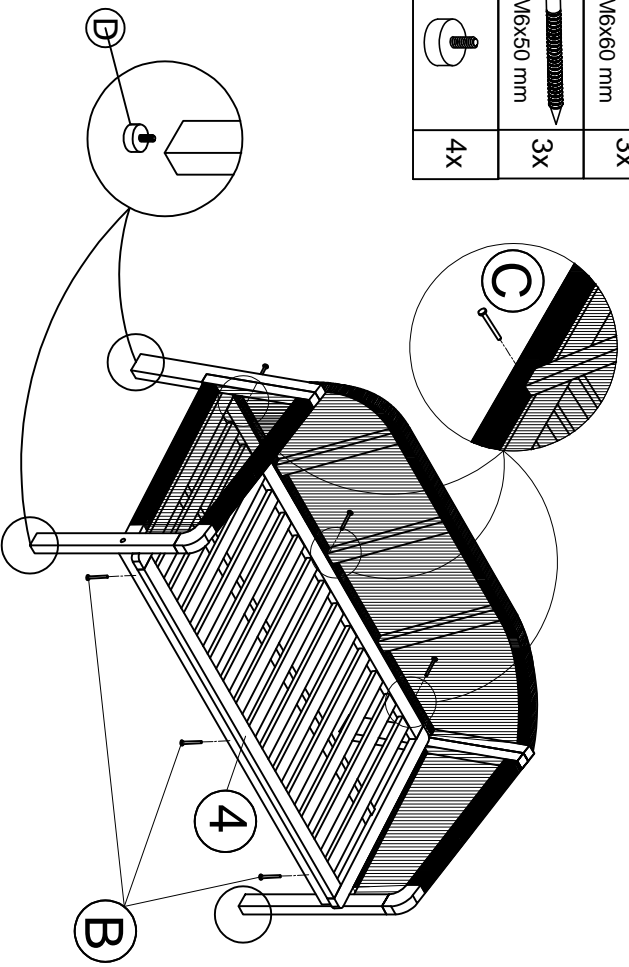

4

