

**USER'S MANUAL**  
**Octagon Metal Gazebo**  
**OP70383**



















THIS INSTRUCTION BOOKLET CONTAINS **IMPORTANT** SAFETY INFORMATION. PLEASE READ AND KEEP FOR FUTURE REFERENCE.

---







- ⊙ Please read all instructions carefully.
- ⊙ Retain instructions for future reference.
- ⊙ Separate and count all parts and hardware.
- ⊙ Read through each step carefully and follow the proper order.
- ⊙ We recommend that, where possible, all items are assembled near to the area in which they will be placed in use, to avoid moving the product unnecessarily once assembled.
- ⊙ Always place the product on a flat, steady and stable surface.
- ⊙ Keep all small parts and packaging materials for this product away from babies and children as they potentially pose a serious choking hazard.

Thank you for purchasing this quality product. Be sure to check all packing material carefully for small parts that may have come loose inside the carton during shipment.

### PARTS LIST

	Description	Sketch	QTY
A1	Top connector 1		1 PC
A2	Top connector 2		1 PC
B1	Finial		1 PC
B2	Hook		1 PC
C1	Connector 1		4 PCS
C2	Connector 2		4 PCS
D1	Side post 1		4 PCS
D2	Side post 2		4 PCS
E	Corner connector		8 PCS
F	Screen 1		4 PCS
G	Screen 2		2 PCS
H	Screen 3		2 PCS
I	Post 1		4 PCS
J	Post 2		4 PCS
K	Fence		4 PCS
L	Small Canpy		1 PC
M	Large Canopy		1 PC
N	Mosquito netting		1 PC

### HARDWARE LIST

	Description	Sketch	QTY
AA	Bolt (M6x15)		32 PCS
BB	Washer		48 PCS
CC	Bolt (M6x35)		16 PCS
DD	Anchor		16 PCS
EE	Wrench		1 PC
FF	Ring		60 PCS

## STEP 1

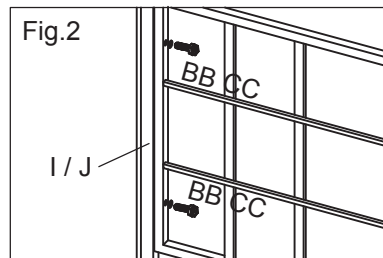
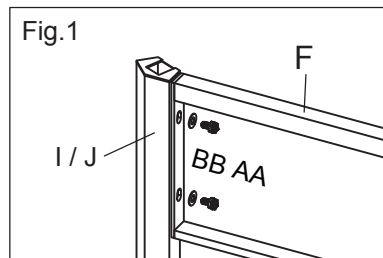
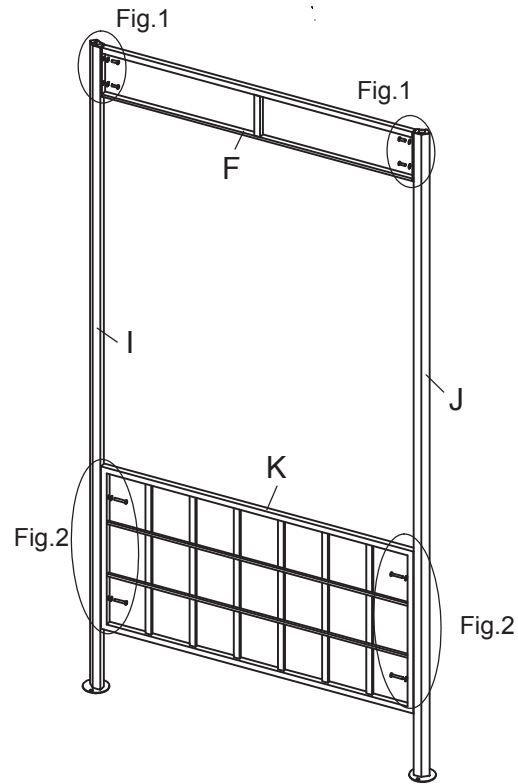

Fig.1: Using bolt (AA) and flat washer (BB) to assemble the screen 1 (F) to the post 1 (I) or post 2 (J)

Fig.2: Using bolt (CC) and flat washer (BB) to connect the fence (K) to the post 1 (I) or post 2 (J).

## STEP 2

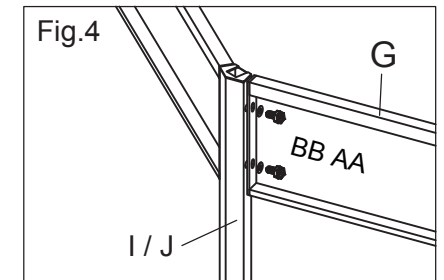
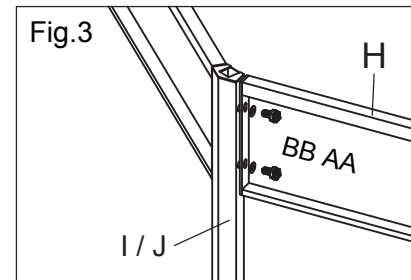
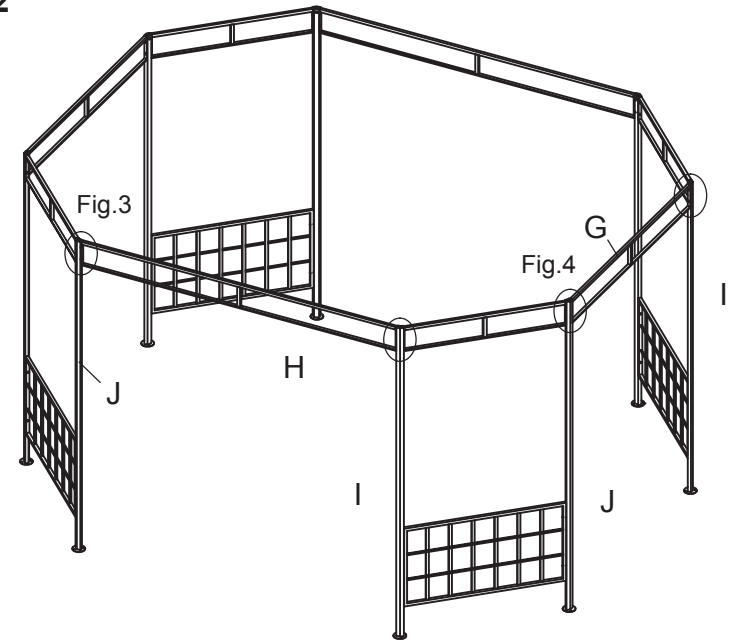

Fig.3: Using bolt (AA) and flat washer (BB) to connect the screen 3 (H) to the post 1 (I) or post 2 (J).

Fig.4: Using bolt (AA) and flat washer (BB) to connect screen 2 (G) to the post 1 (I) or post 2 (J). Secure all bolts by using wrench (EE).

### STEP 3

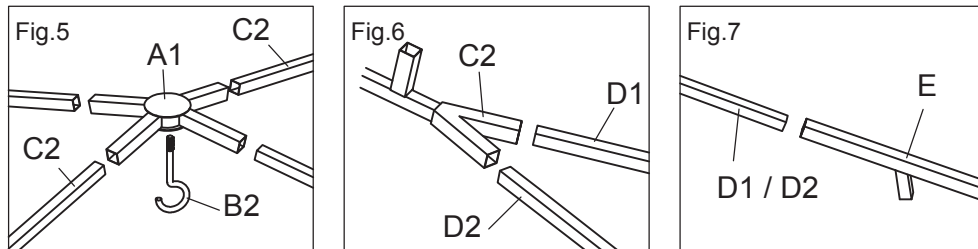
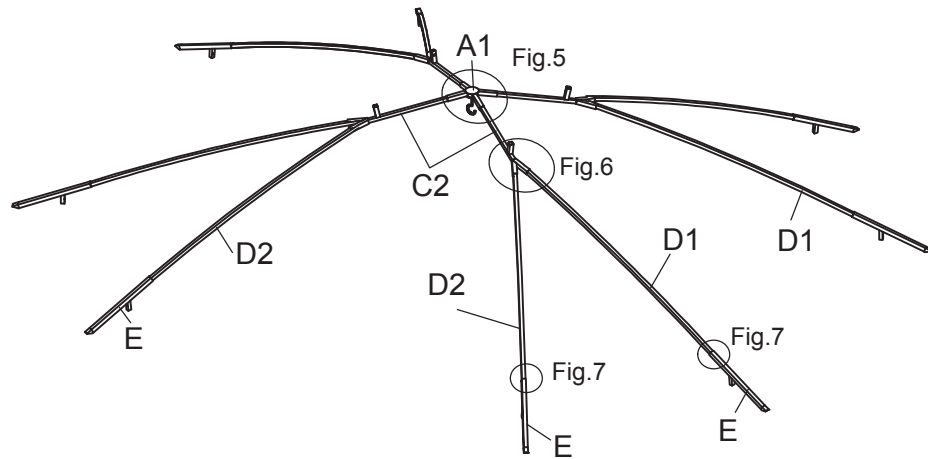

Fig.5: Insert connector 2 (C2) to top connector 1 (A1) and attach hook (B2) to top connector 1 (A1).

Fig.6: Insert side post 1 (D1) and side post 2 (D2) into connector 2 (C2).

Fig.7: Insert assembly side post 2 (D2) and side post 1 (D1) into corner connector (E).

### STEP 4

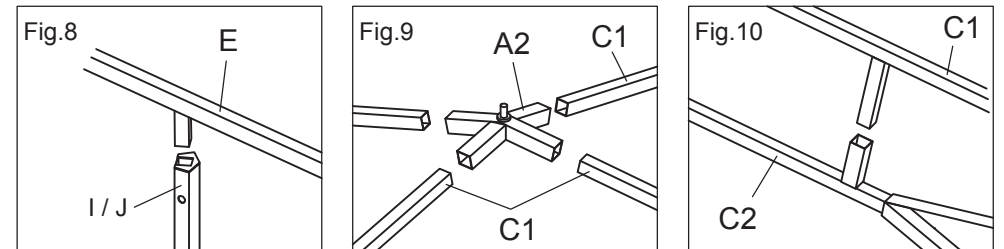
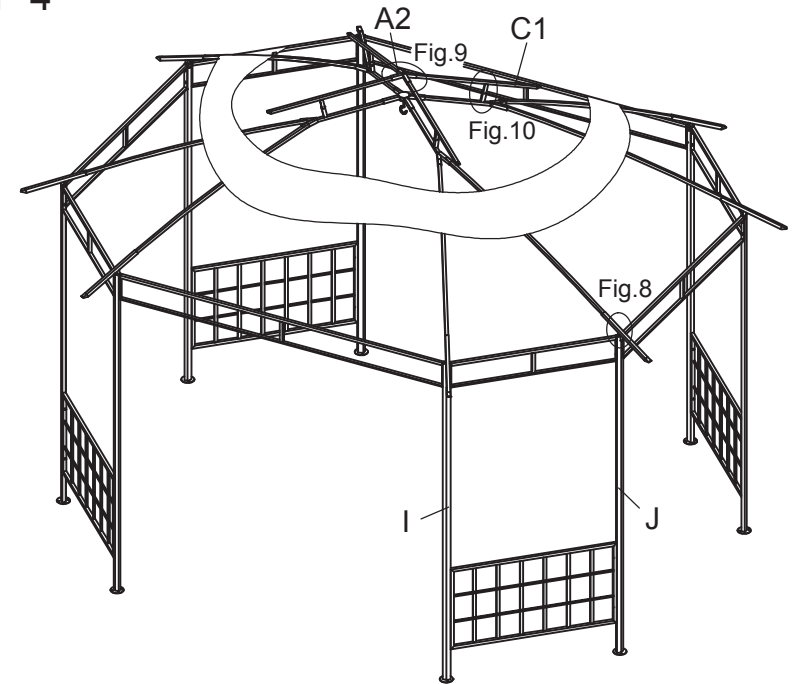

Fig.8: Insert corner connector (E) to the other end of post 1 (I) & post 2 (J). Cover large canopy (M) to the big top. (Note: The bigger corner of top connector 2 (A2) should point to the screen 3 (H)).

Fig.9: Insert connector 1 (C1) into top connector 2 (A2), cover small canopy (L) to the small top. Then attach finial (B1) to top connector 2 (A2).

Fig.10: Insert the connect tube of connector 1 (C1) onto connector 2 (C2) and then spread out large canopy (M).

# STEP 5

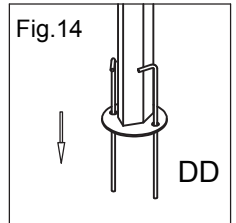
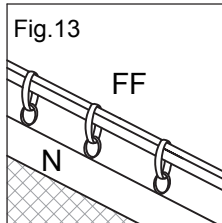
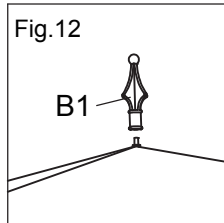
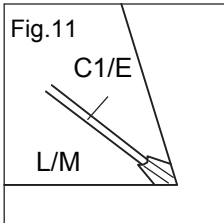
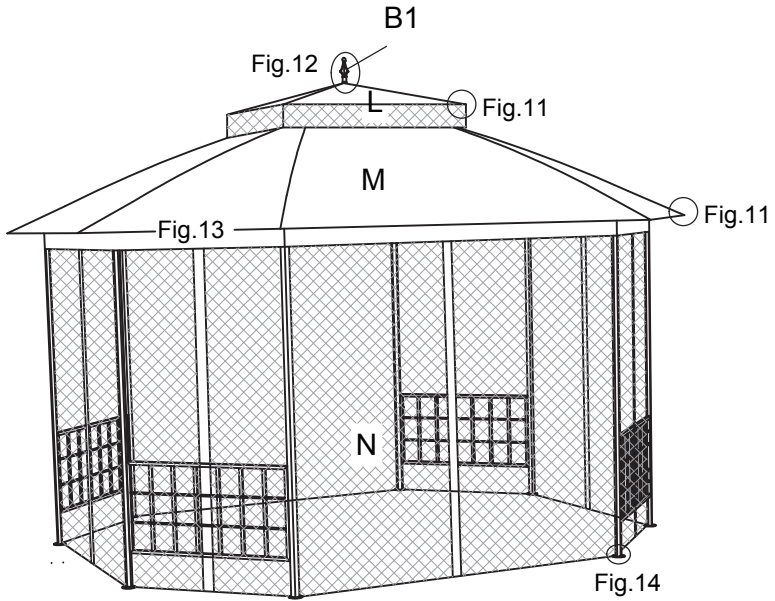

Fig.13: Hanging the mosquito netting (N) to screen 3/1/2 (H/ F/ G) by ring (FF).

Fig.14: Fix the gazebo by stake (DD).