

CARE AND MAINTENANCE

Store outdoor furniture indoors or cover well when not in use.

Remove wooden furniture from standing water. Dust regularly with small brush or vacuum

Spills should be taken care of immediately before they harden or stain with a slightly dampened sponge.

NOTICE

- * Please make sure that you have all parts indicated before you begin assembly of this item
- * This item should be assembled on a soft surface to prevent scratching the finish during assembly
- * This item may require periodic tightening

 **SAFAVIEH**
O U T D O O R







Weight Capacity : 600 lbs

Warning : Do not stand on bench

Warning : Do not over torque bolts / screws



Part List and Hardware List

PIECE	DESCRIPTION	PICTURE	QUANTITY
A	Leg Frame		2X
B	Seat Frame		1X
C	Back frame		1X
D	Screw -1	 M6X80	2X
E	Screw -1	 M6X60	8X
H	Allen key	 LG5	1X

Model# PAT7007

Product Dimensions:46.85" W x 26.38" D x 32.48" H



PREPARATION

Before beginning assembly of product, make sure all parts are present. Compare parts with package contents list and hardware contents list. If any part is missing or damaged, do not attempt to assemble the product.

Estimated Assembly Time: 10 minutes.

Tools Required for Assembly (included): Allen Key

1

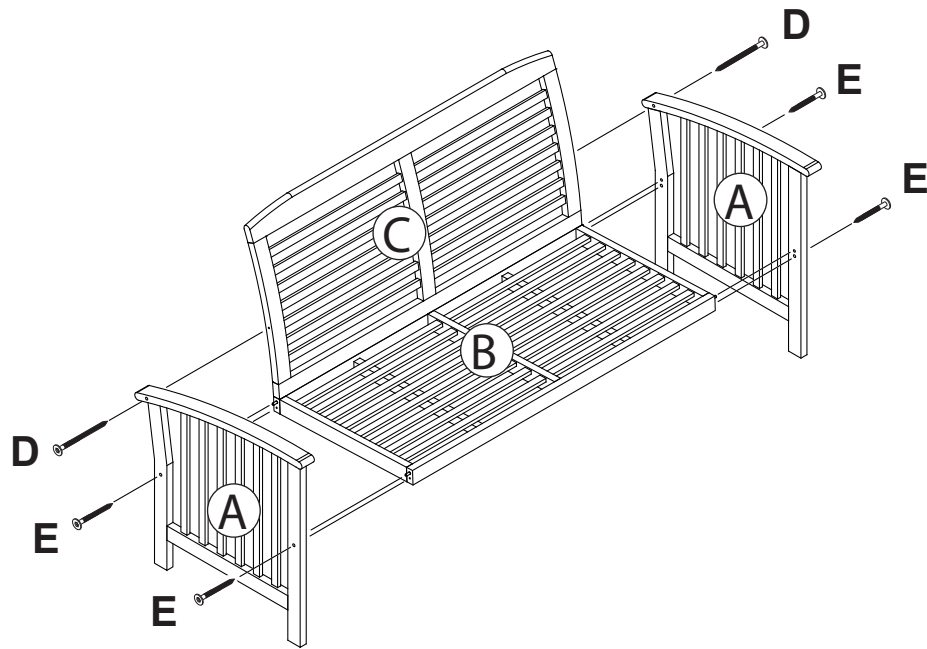

Step 1

Attach leg frame (A) to back frame (C), use screws-1 (D), tighten with allen key(H1). Use screw -1 (E) to connect leg frame (A) with seat frame (B), tighten with allen key (H1).

2

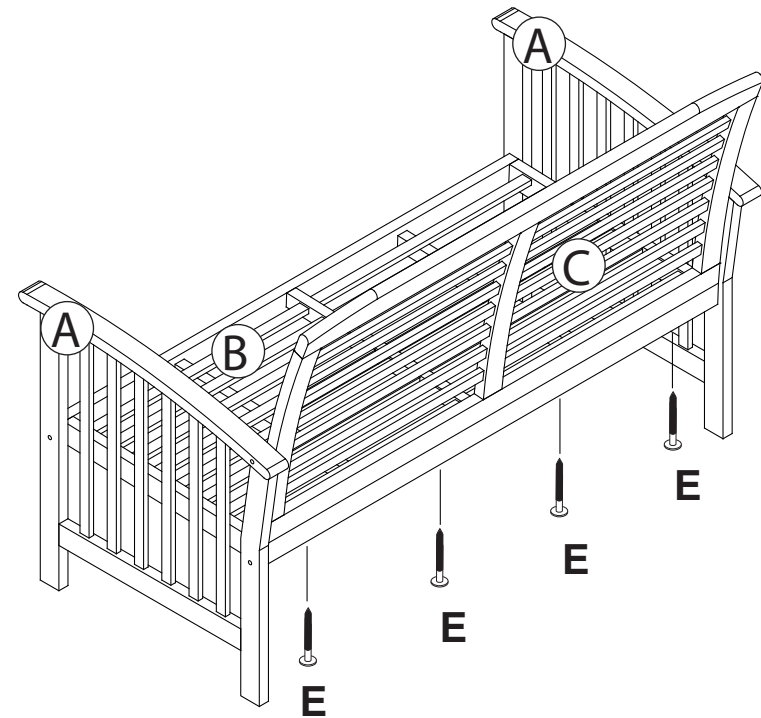

Step 2

Tighten screw- 1 (E) with allen key (H1) to attach seat frame (B) and back frame (C)

CARE AND MAINTENANCE

Store outdoor furniture indoors or cover well when not in use.
Remove wooden furniture from standing water. Dust regularly with small brush or vacuum
Spills should be taken care of immediately before they harden or stain with a slightly dampened sponge.

NOTICE

- * Please make sure that you have all parts indicated before you begin assembly of this item
- * This item should be assembled on a soft surface to prevent scratching the finish during assembly
- * This item may require periodic tightening



SAFAVIEH

OUTDOOR







Weight Capacity : 275 lbs

Warning : Do not stand on chair

Warning : Do not over torque bolts / screws



Part List and Hardware List

PIECE	DESCRIPTION	PICTURE	QUANTITY
A	Leg Frame		2X
B	Seat Frame		1X
C	Back frame		1X
D	Screw -1	 M6X80	2X
E	Screw -1	 M6X60	6X
H	Allen key	 LG5	1X

Model# PAT7007

Product Dimensions: 23.23" W x 26.38" D x 32.48" H



PREPARATION

Before beginning assembly of product, make sure all parts are present. Compare parts with package contents list and hardware contents list. If any part is missing or damaged, do not attempt to assemble the product.

Estimated Assembly Time: 10 minutes.

Tools Required for Assembly (included): Allen Key

1

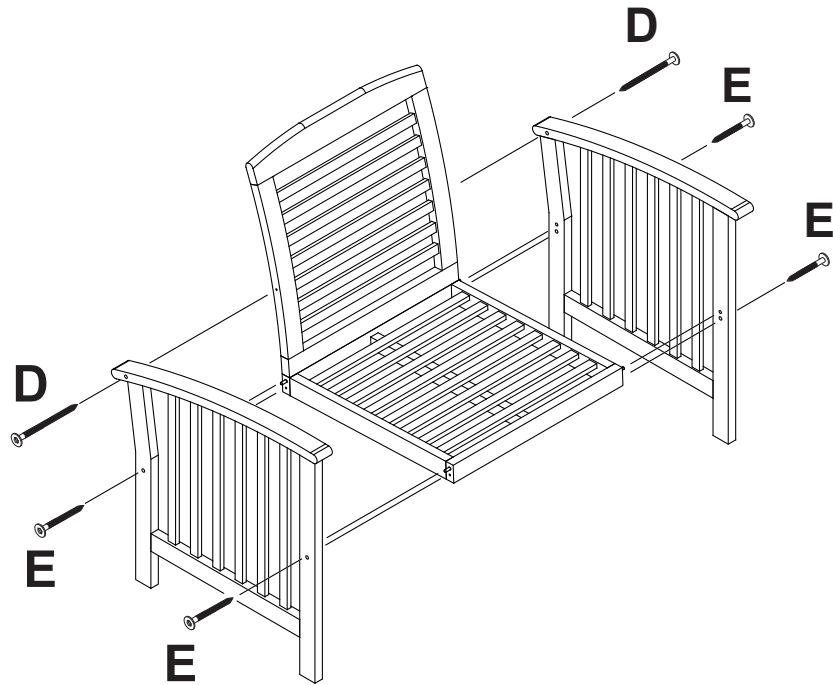

Step 1

Attach leg frame (A) to back frame (C), use screws-1 (D), tighten with allen key(H1). Use screw -1 (E) to connect leg frame (A) with seat frame (B), tighten with allen key (H1).

2

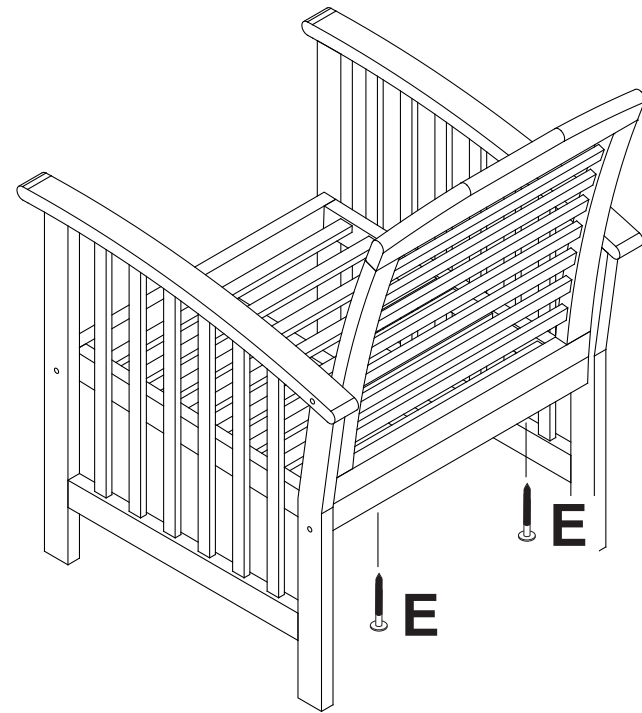

Step 2

Tighten screw- 1 (E) with allen key (H1) to attach back frame(C)

CARE AND MAINTENANCE

Store outdoor furniture indoors or cover well when not in use.
Remove wooden furniture from standing water. Dust regularly with small brush or vacuum
Spills should be taken care of immediately before they harden or stain with a slightly dampened sponge.

NOTICE

- * Please make sure that you have all parts indicated before you begin assembly of this item
- * This item should be assembled on a soft surface to prevent scratching the finish during assembly
- * This item may require periodic tightening

 **SAFAVIEH**
O U T D O O R





Weight Capacity : 40 Ibs

Warning : Do not stand on table

Warning : Do not over torque bolts / screws

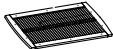

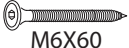
Part List and Hardware List

PIECE	DESCRIPTION	PICTURE	QUANTITY
A	Leg frame		2X
B	Top table		1X
C	Cross bar		2X
D	Cross bar		1X
E	Screw	 M6X60	12X
H	Allen key	 LG5	1X

Model# PAT7007

Product Dimensions:40.15" W x 19.68" D x 16.93" H

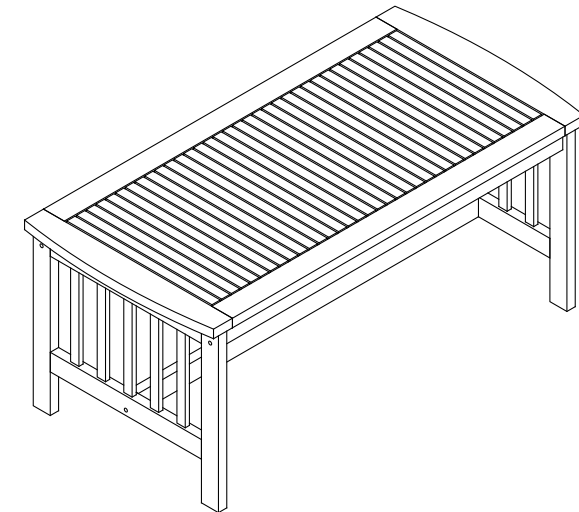

PREPARATION

Before beginning assembly of product, make sure all parts are present. Compare parts with package contents list and hardware contents list. If any part is missing or damaged, do not attempt to assemble the product.

Estimated Assembly Time: 10 minutes.

Tools Required for Assembly (included): Allen Key

1

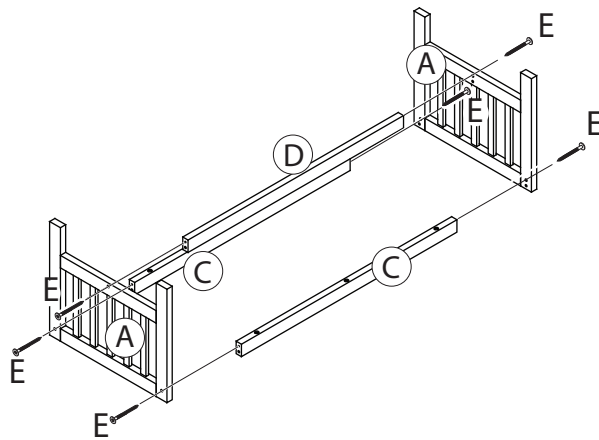

Step 1

Attach Leg frame (A) to (C),(D),use allen key (H) to tighten screws (E).

2

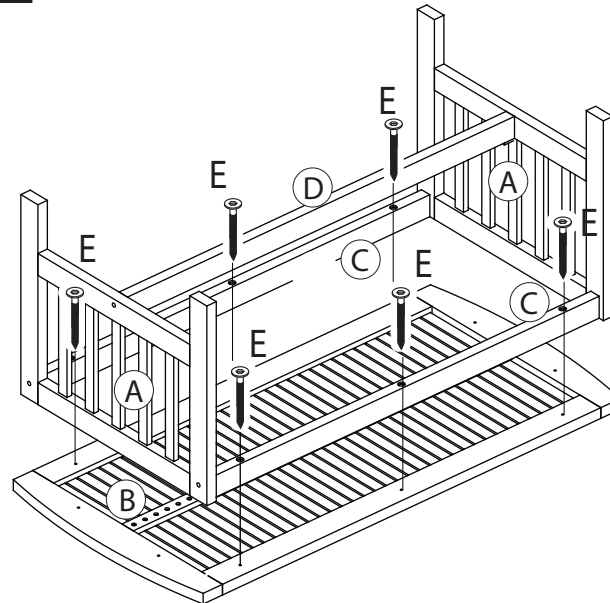

Step 2

Attach (A),(C),(D) to (B), use allen key (H) to tighten screws(E).

3

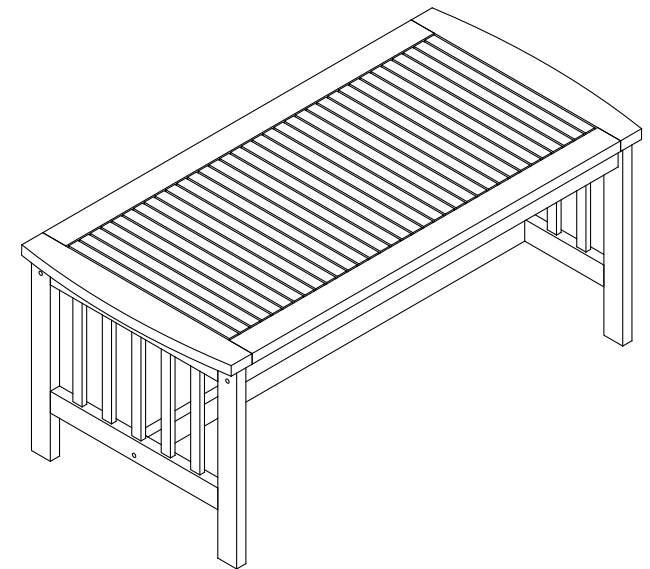

Step 3

Complete.