

Features

- A single handle controls both on/off activation and temperature setting
- 5-5/16" (135 mm) spout reach
- 0.5 gpm (1.9 lpm) maximum flow rate at 60 psi (4.14 bar)
- KOHLER® ceramic disc valves exceed industry longevity standards for a lifetime of durable performance
- Clicker drain with tailpiece
- Part of the Occasion bathroom faucet and accessory collection

Material

- Premium metal construction for durability and reliability
- KOHLER finishes resist corrosion and tarnishing

Installation

- Single hole
- Preattached flexible supply lines simplify installation

Recommended Products/Accessories

K-23726 Drain treatment



ADA **CSA B651** **OBC**

Codes/Standards









ASME A112.18.1/CSA B125.1
 NSF/ANSI/CAN 61
 NSF/ANSI/CAN 372
 DOE - Energy Policy Act 1992
 California Energy Commission (CEC)
 ADA
 ICC/ANSI A117.1
 CSA B651
 OBC

KOHLER® Faucet Lifetime Limited Warranty

See website for detailed warranty information.

Available Colors/Finishes

Color tiles intended for reference only.

Color	Code	Description
	CP	Polished Chrome
	SN	Vibrant® Polished Nickel
	AF	Vibrant® French Gold
	BN	Vibrant® Brushed Nickel
	BV	Vibrant® Brushed Bronze
	BL	Matte Black
	2MB	Vibrant® Brushed Moderne Brass
	BMB	Matte Black with Moderne Brass
	TT	Vibrant Titanium

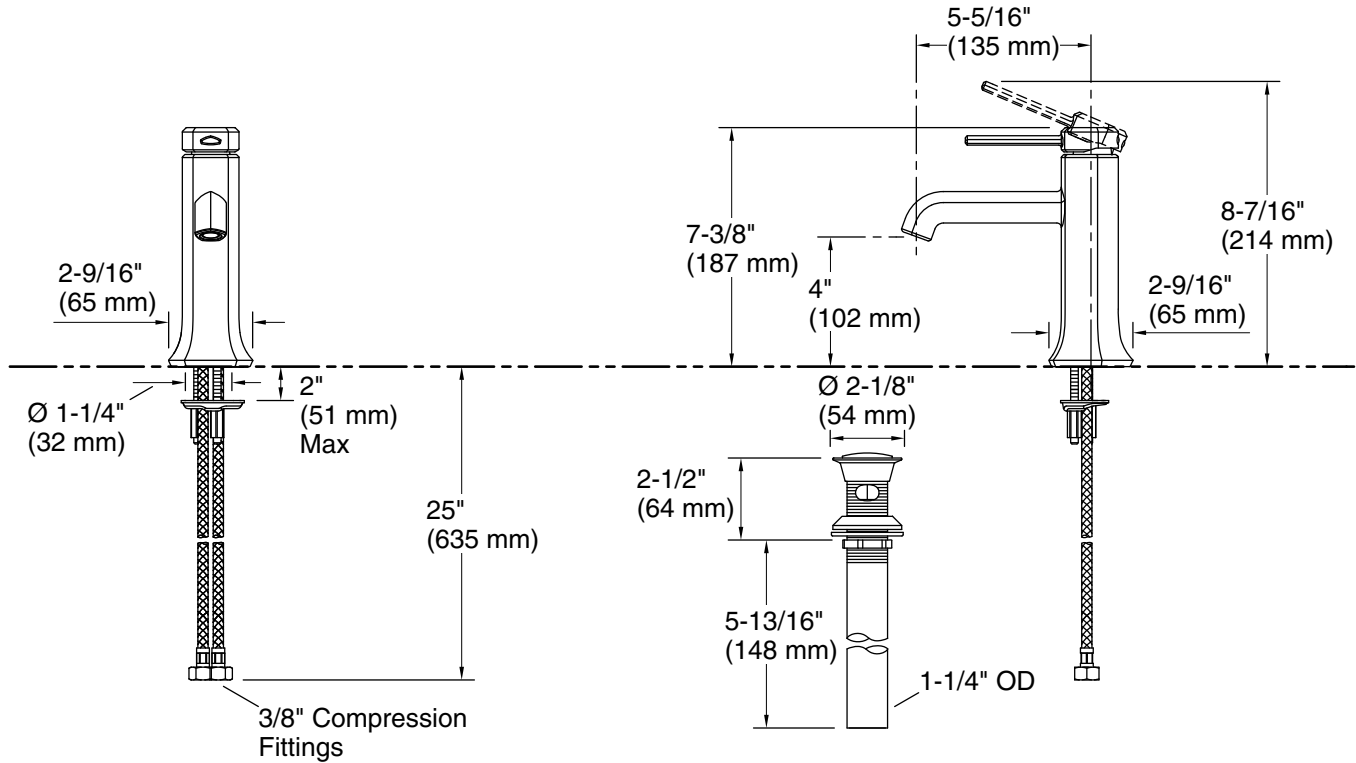

Technical Information

All product dimensions are nominal.

Faucet flow rate: 0.5 gal/min (1.9 l/min)

Drain included: Yes

Drain with overflow: Yes

Drain tailpiece included: Yes

Spout:

Spout reach: 5-5/16" (135 mm)

Notes

ADA, OBC, CSA B651 compliant when installed to the specific requirements of these regulations.