

EN



Before You Start

- ⚠ Please read all instructions carefully.
- ⚠ Retain instructions for future reference.
- ⚠ Separate and count all parts and hardware.
- ⚠ Read through each step carefully and follow the proper order.
- ⚠ We recommend that, where possible, all items are assembled near to the area in which they will be placed in use, to avoid moving the product unnecessarily once assembled.
- ⚠ Always place the product on a flat, steady and stable surface.
- ⚠ Keep all small parts and packaging materials for this product away from babies and children as they potentially pose a serious choking hazard.

DE



Vor dem Beginnen

- ⚠ Bitte lesen Sie alle Anweisungen sorgfältig durch.
- ⚠ Bewahren Sie die Anweisungen zur zukünftigen Verwendung auf.
- ⚠ Überprüfen Sie, ob alle Teile und Zubehörteile vorhanden sind.
- ⚠ Lesen Sie jeden Schritt sorgfältig durch und befolgen Sie die richtige Reihenfolge.
- ⚠ Wir empfehlen, alle Teile möglichst in der Nähe des Aufstellungsortes zu montieren, um unnötige Bewegungen nach der Montage zu vermeiden.
- ⚠ Stellen Sie den Artikel immer auf eine ebene, feste und stabile Fläche.
- ⚠ Halten Sie alle kleinen Teile und Verpackungsmaterialien fern von Babys und Kindern, ansonsten besteht Erstickengefahr.

FR



Avant de Commencer

- ⚠ Veuillez lire attentivement toutes les instructions.
- ⚠ Conservez les instructions pour vous y référer ultérieurement.
- ⚠ Vérifiez toutes les pièces et les accessoires.
- ⚠ Lisez attentivement chaque étape et suivez l'ordre correct.
- ⚠ Nous recommandons que, dans la mesure du possible, tous les produits soient assemblés à proximité de la zone où ils seront utilisés, afin d'éviter tout déplacement inutile du produit une fois assemblé.
- ⚠ Placez toujours le produit sur une surface plane et stable.
- ⚠ Conservez toutes les petites pièces de ce produit et les matériaux d'emballage hors de portée des bébés et des enfants, car ils pourraient présenter un risque d'étouffement.

ES



Antes de Empezar

- ⚠ Lea atentamente todas las instrucciones.
- ⚠ Conserve las instrucciones para futuras consultas.
- ⚠ Separe y cuente todas las piezas y los accesorios.
- ⚠ Lea detenidamente cada paso y siga el orden correcto.
- ⚠ Recomendamos que, siempre que sea posible, todos los elementos se monten cerca de la zona en la que se van a utilizar, para evitar mover el producto innecesariamente una vez montado.
- ⚠ Coloque siempre el producto sobre una superficie plana, estable y firme.
- ⚠ Mantenga todas las piezas pequeñas y los materiales de embalaje de este producto lejos de los bebés y los niños, ya que pueden representar un grave riesgo de asfixia.

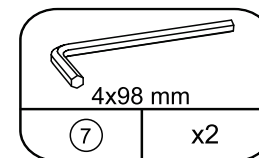
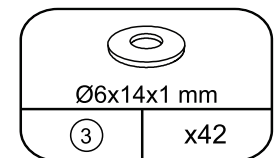
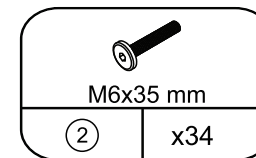
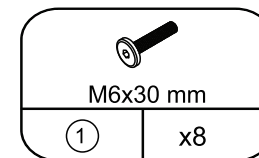
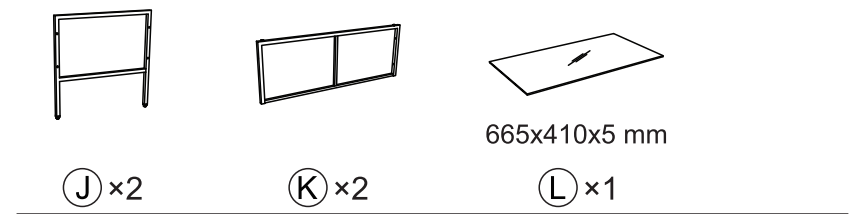
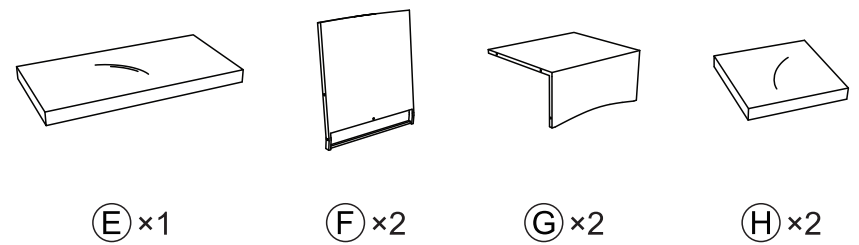
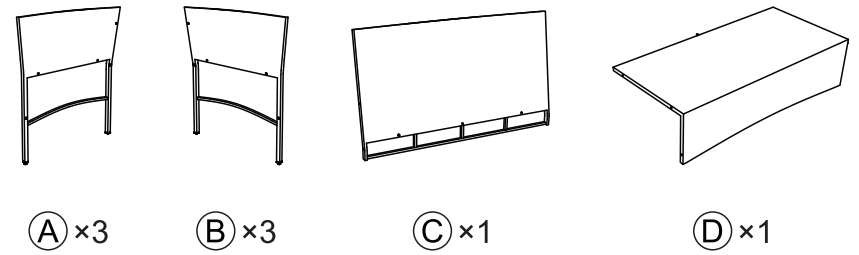
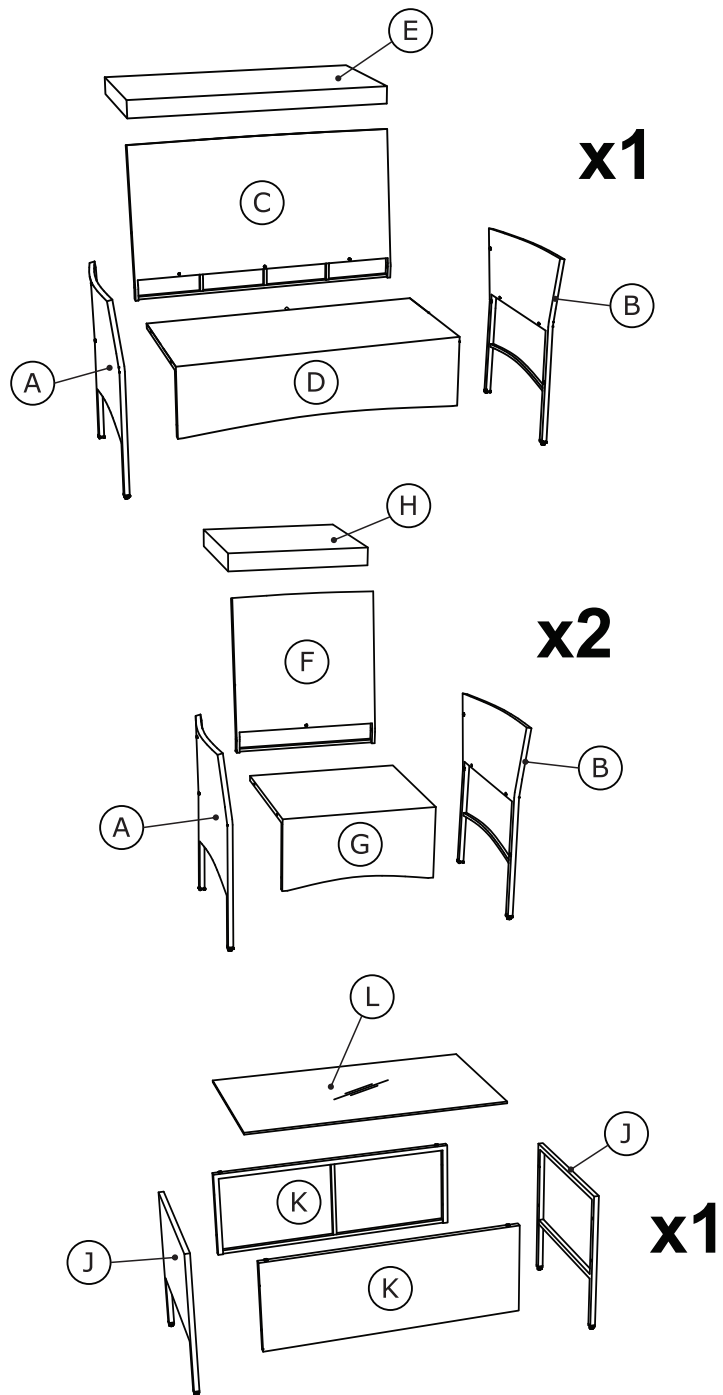

Allen Key
/Inbusschlüssel
/Clé Allen
/Llave Allen
/Chiave Allen
/Klucz Imbusowy
/Inbussleutel

