

A x33

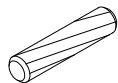

B x33



C x59

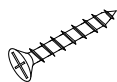

D x8

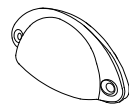

E x2



F x12

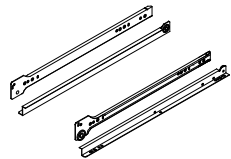

G x2



H x16



I x6

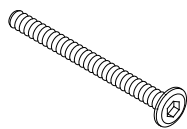

J x12



K x12



L x1

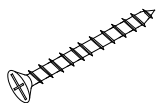

M x2



N x4

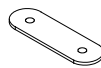

O x3

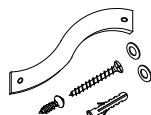

P x2



Q x4

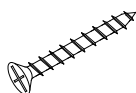

R x5

1

1

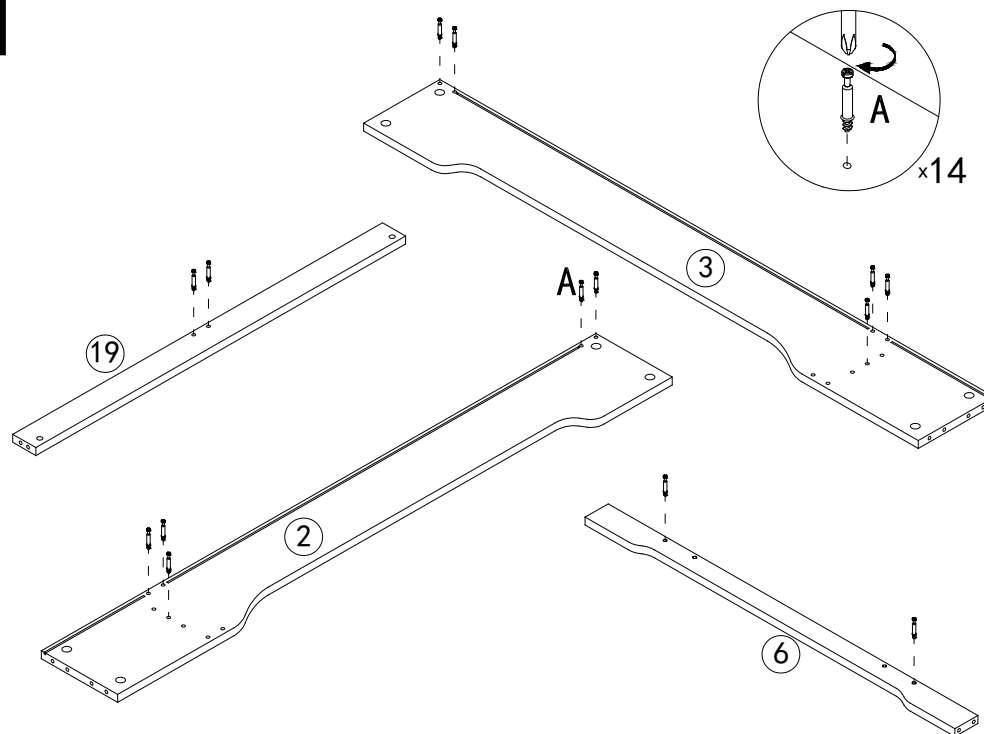

2

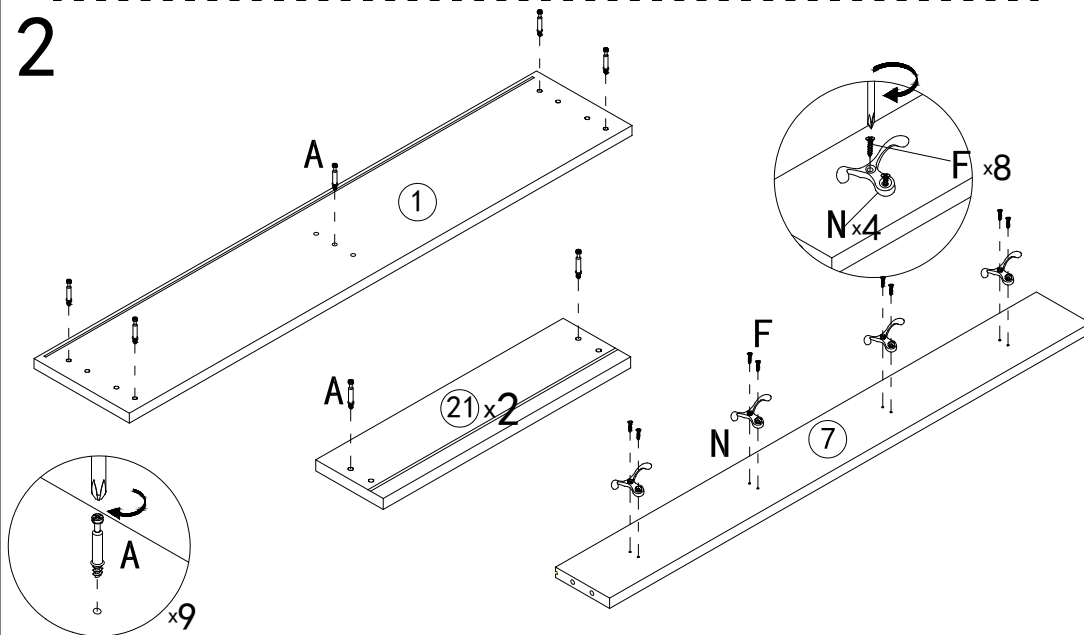

2

3

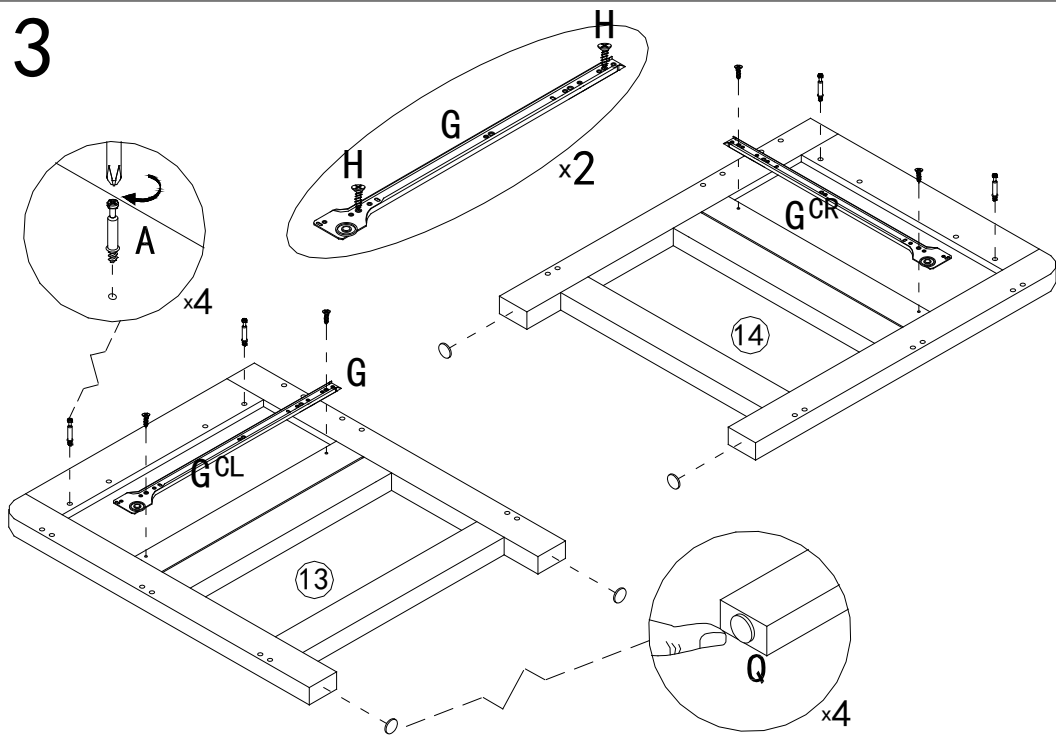

5

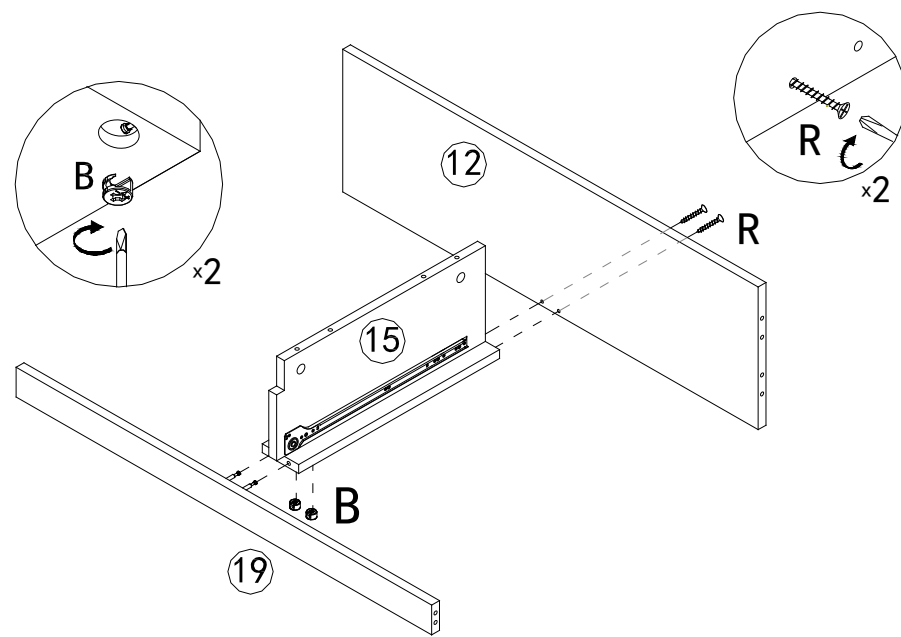

4

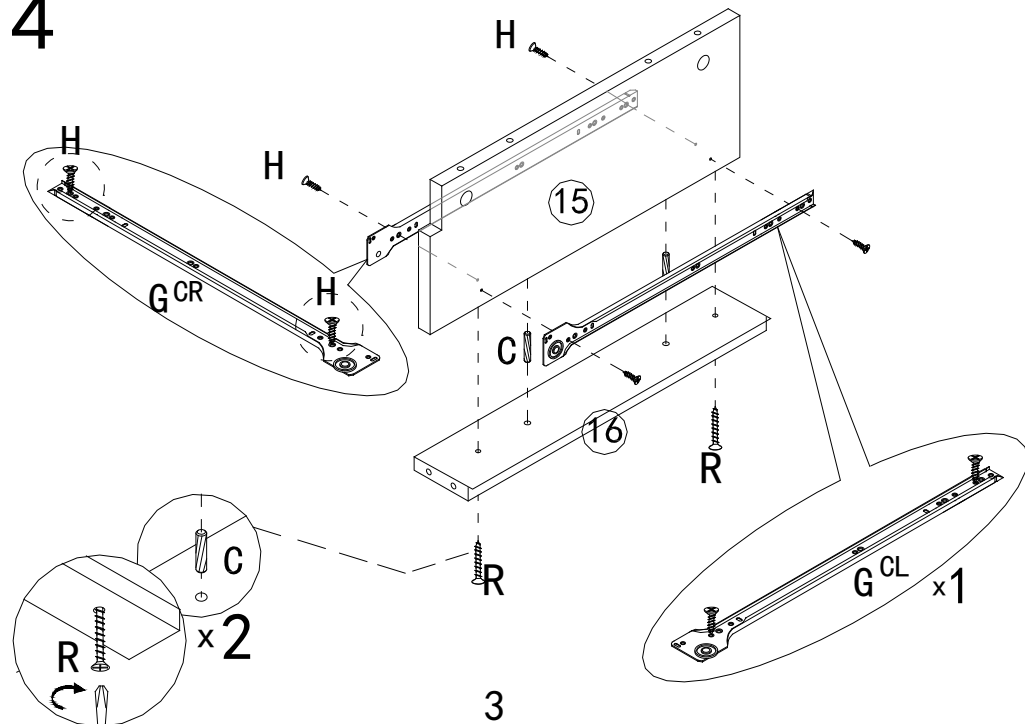

6

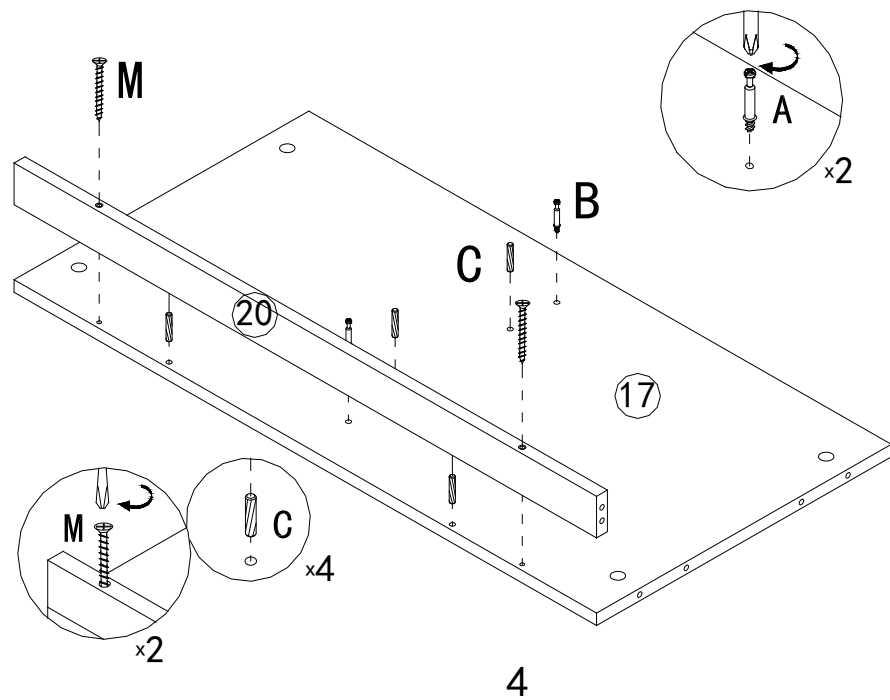

7

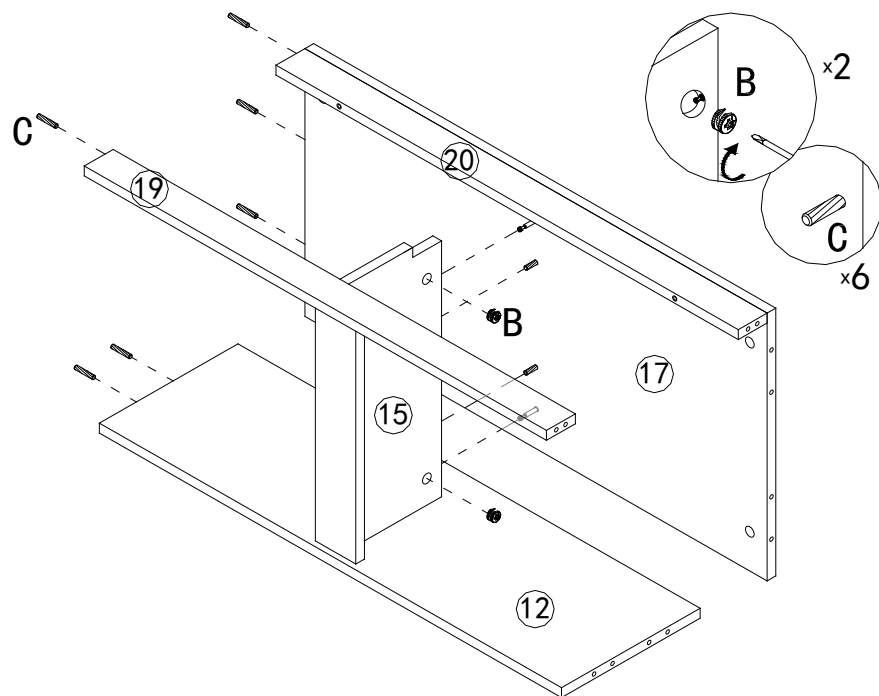

8

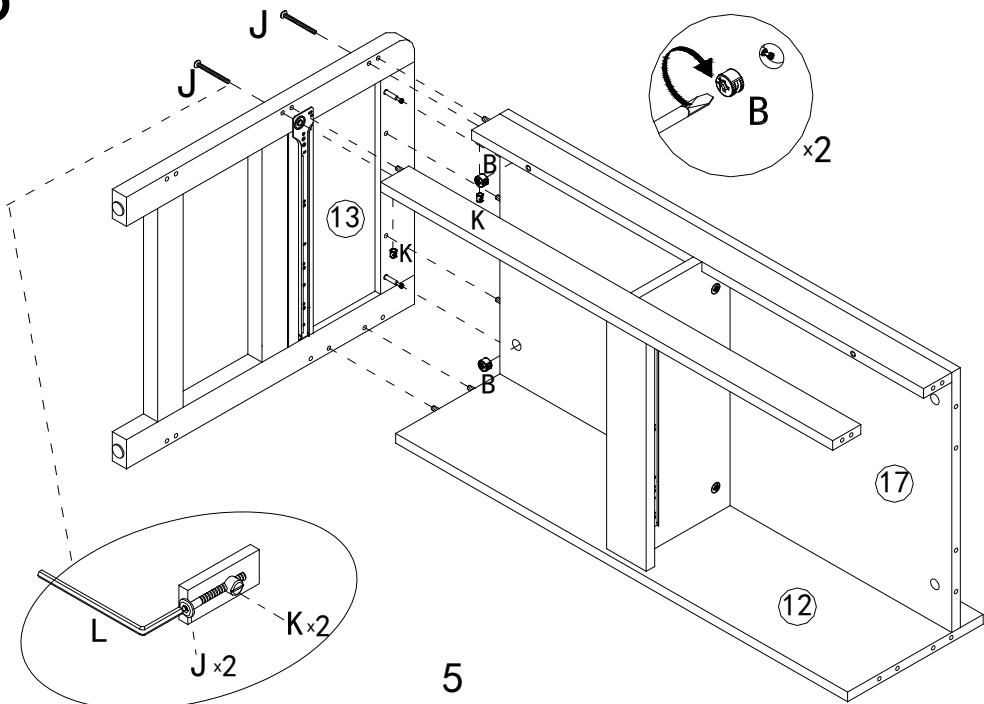

9

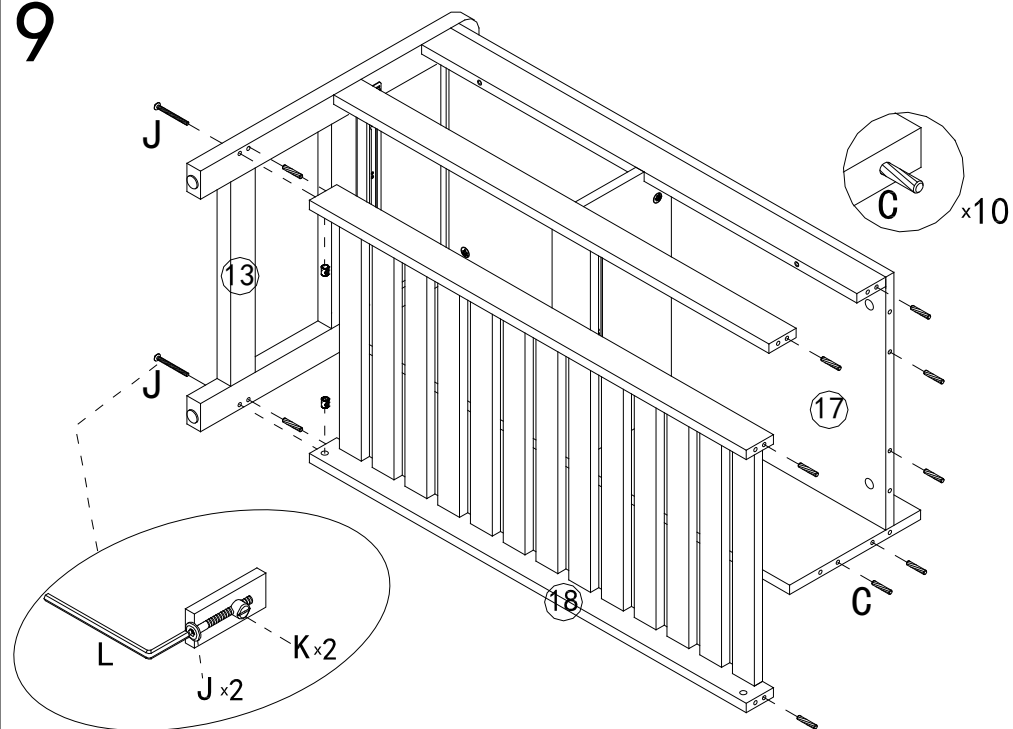

10

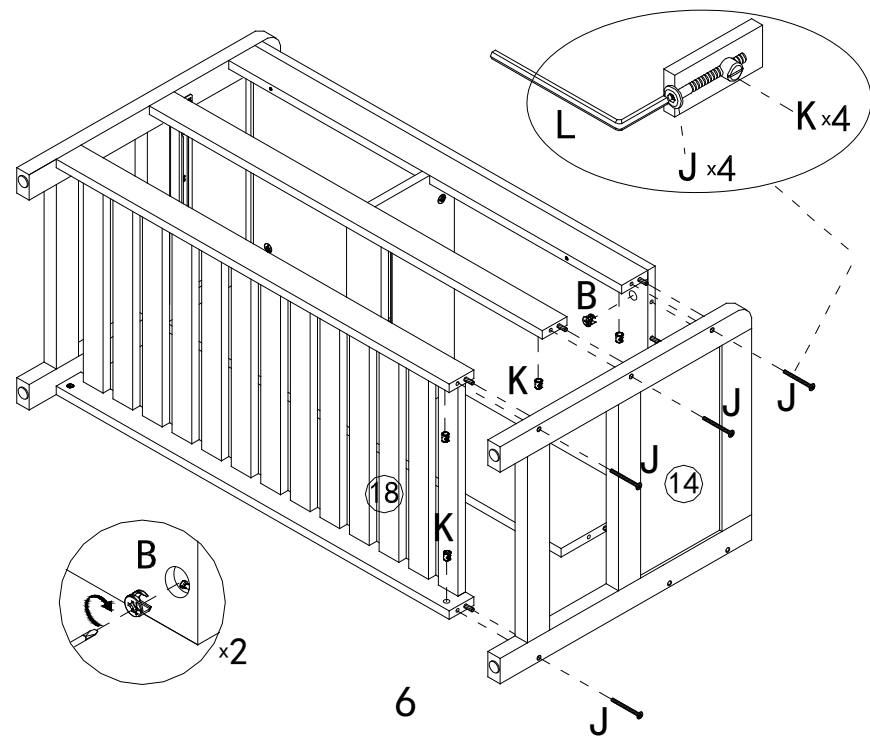

11

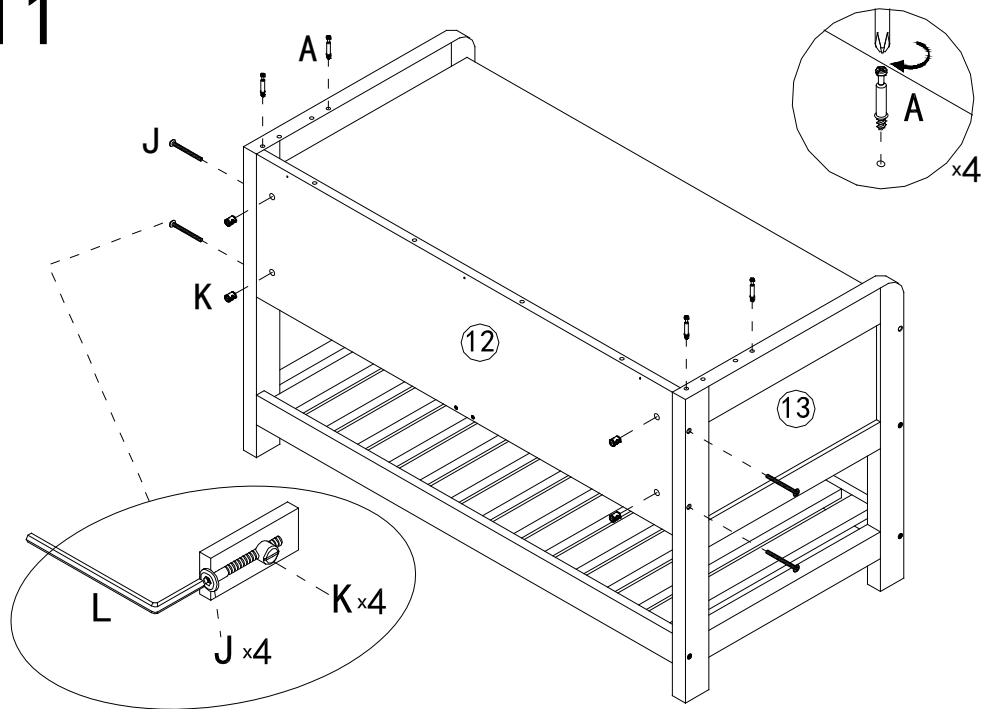

13

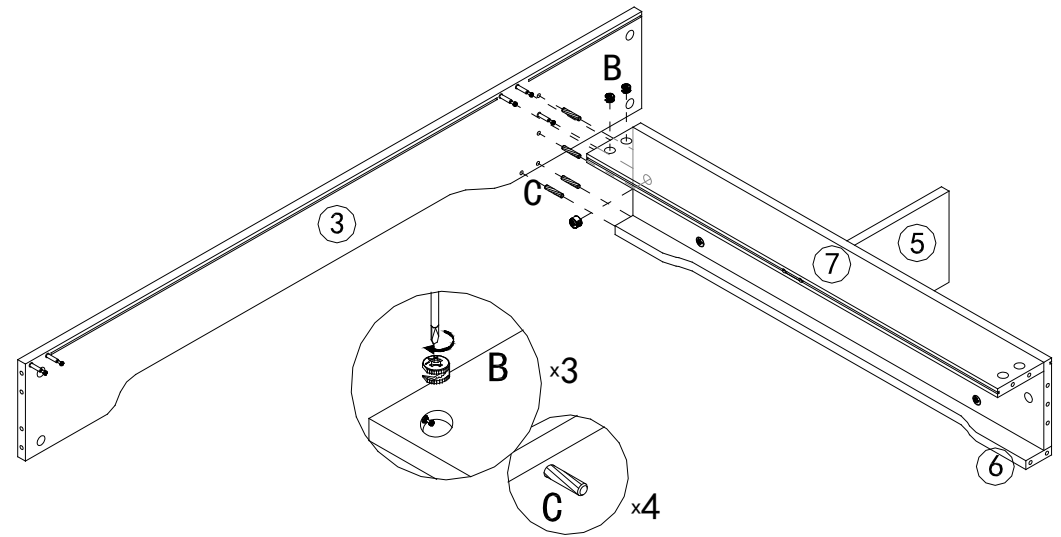

12

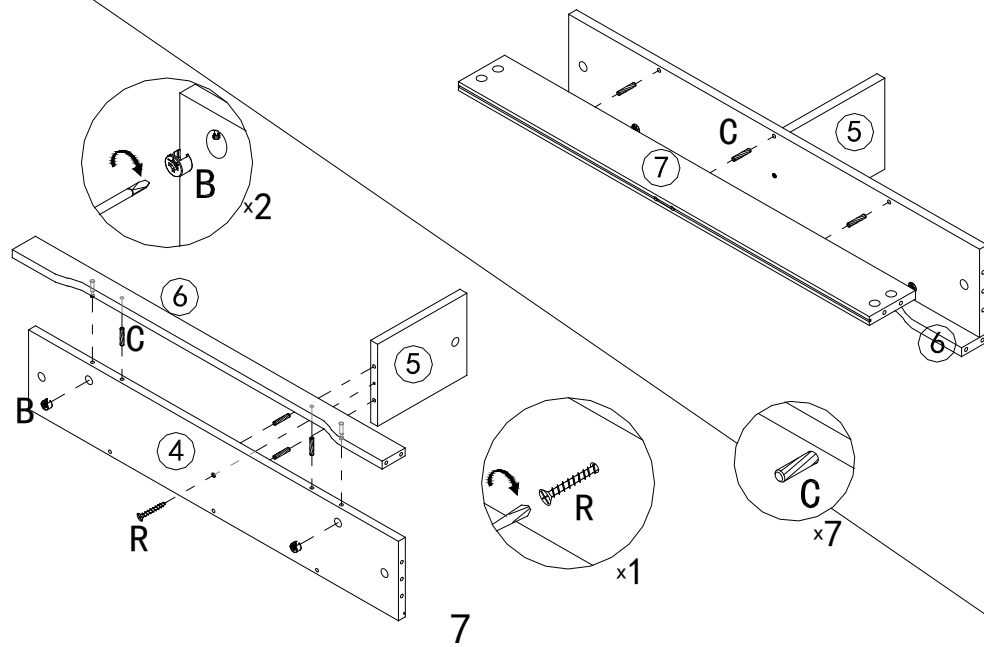

14

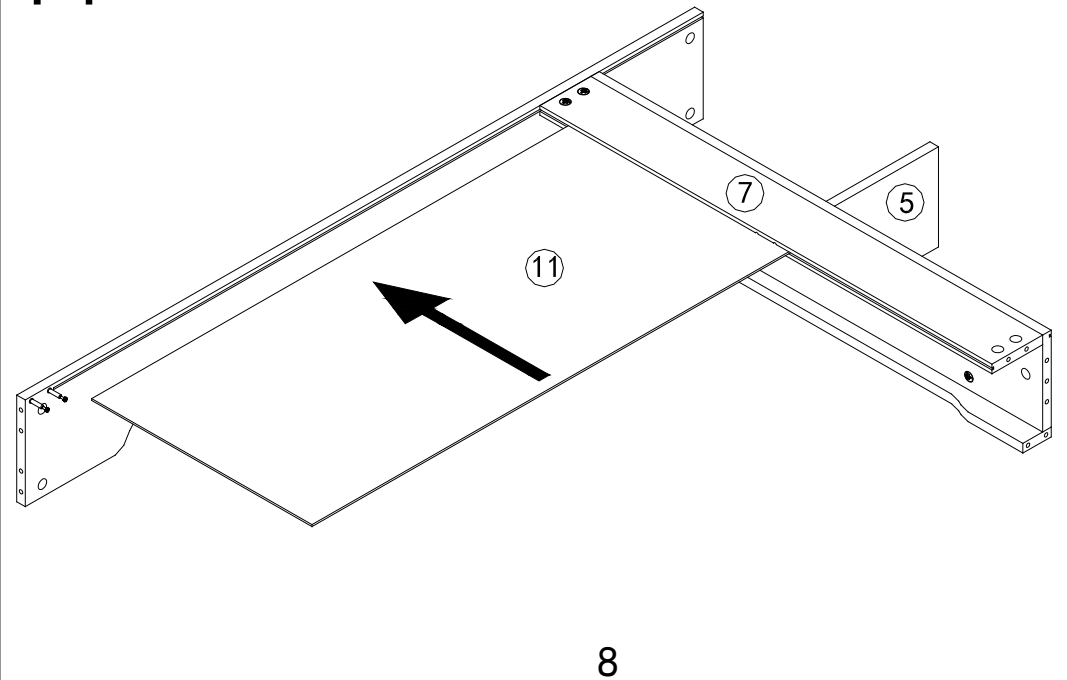

15

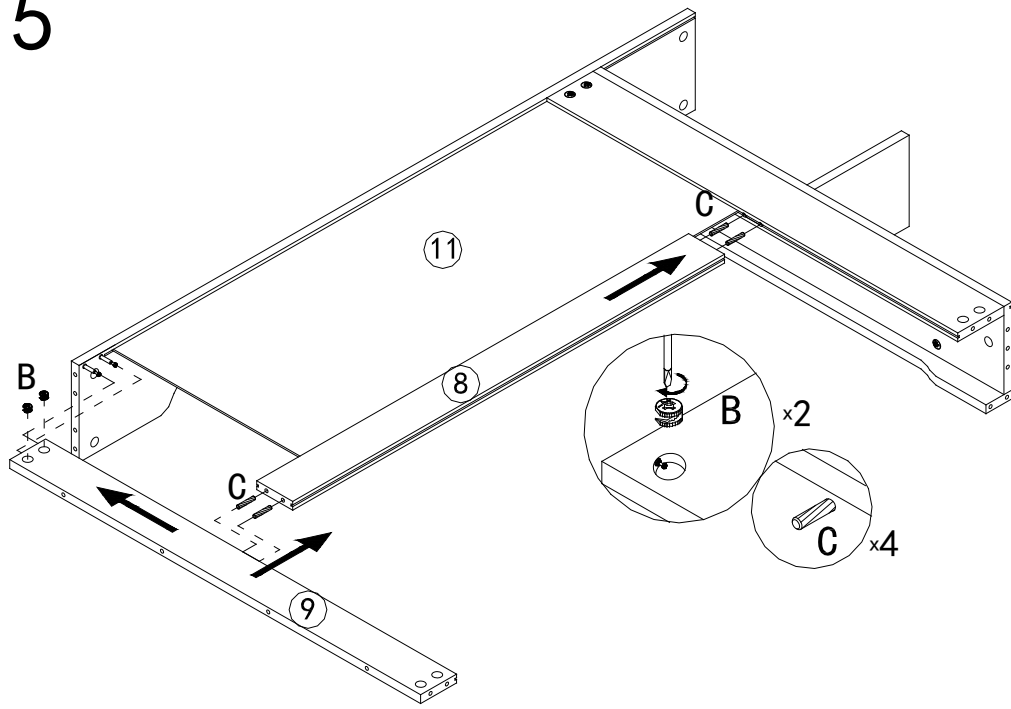

17

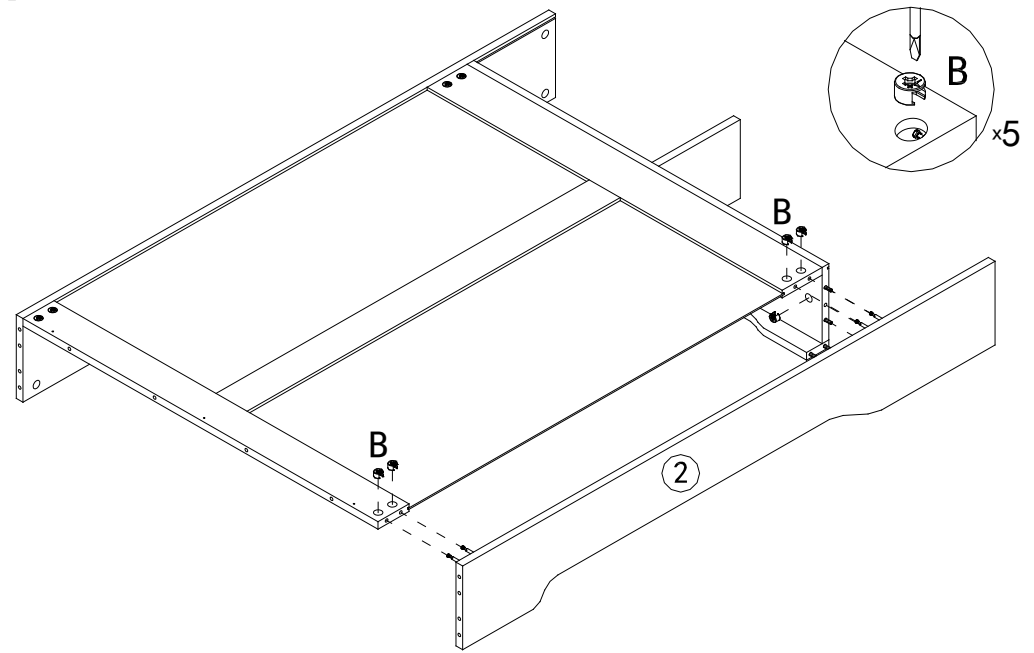

16

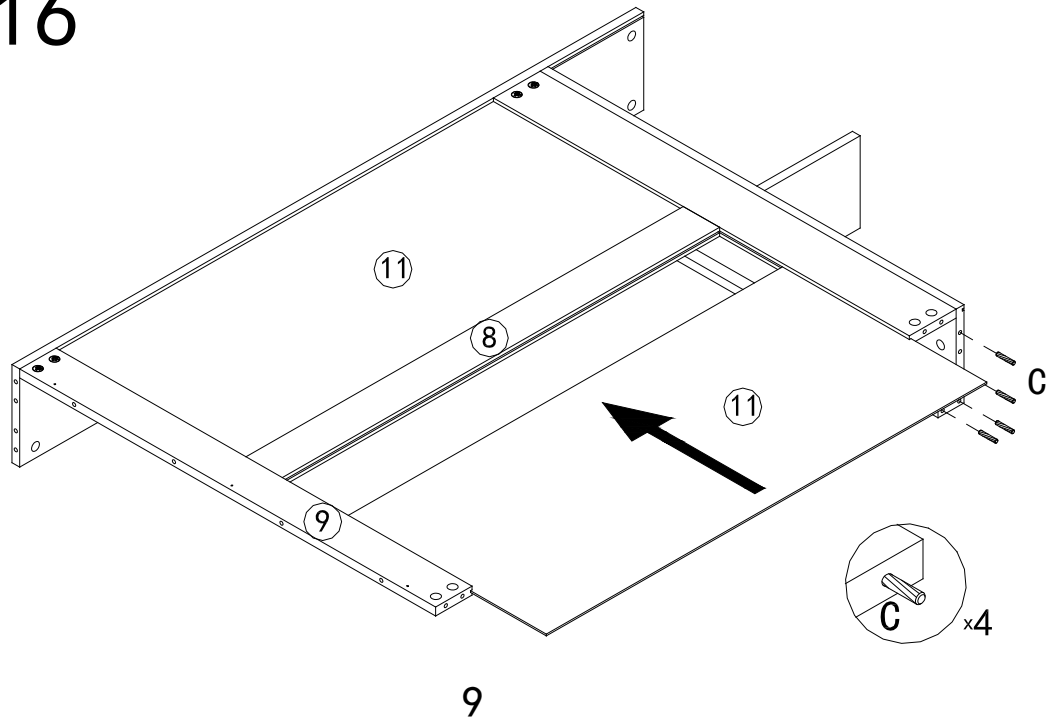

18

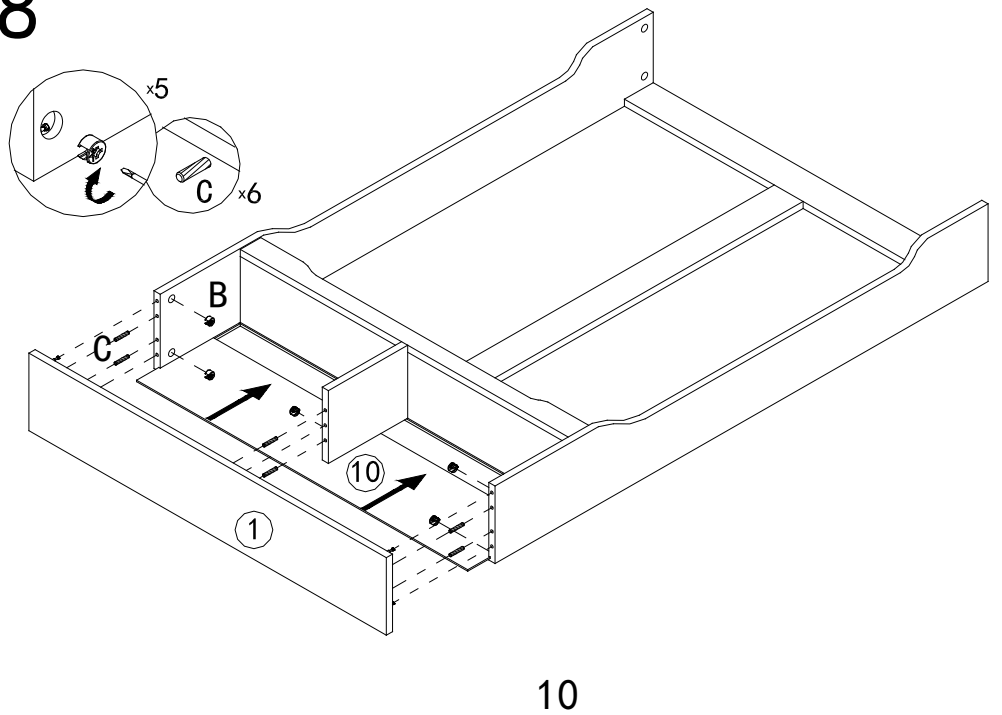

19

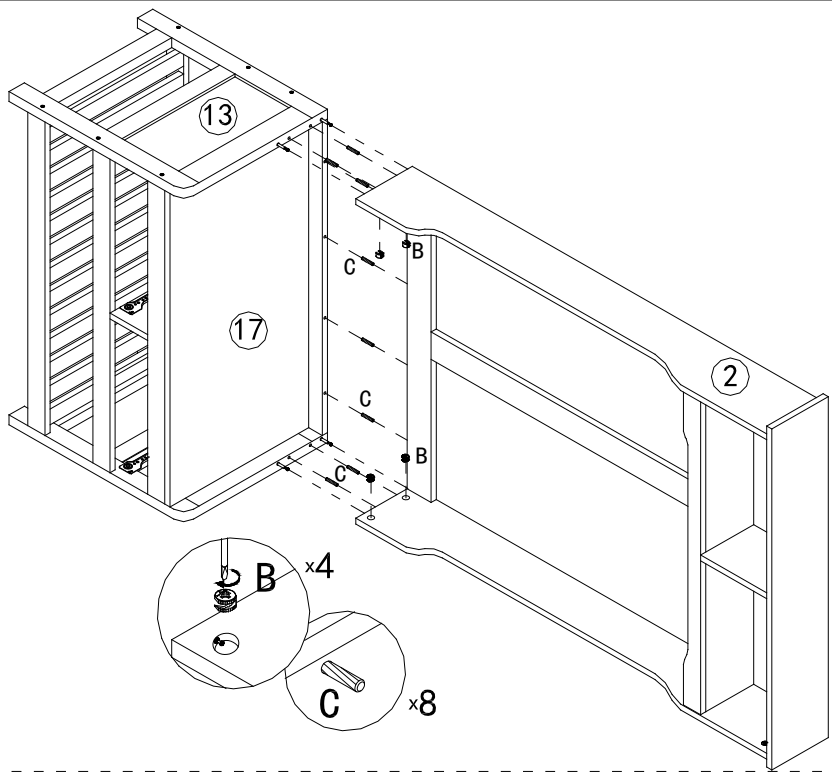

20

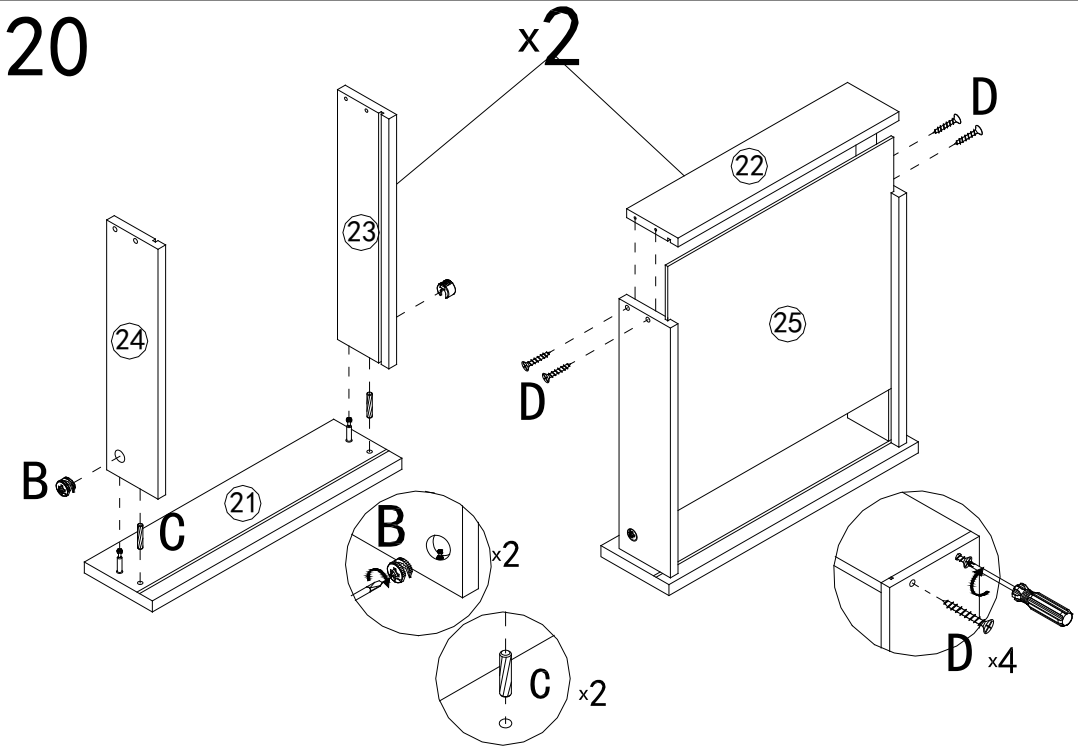

21

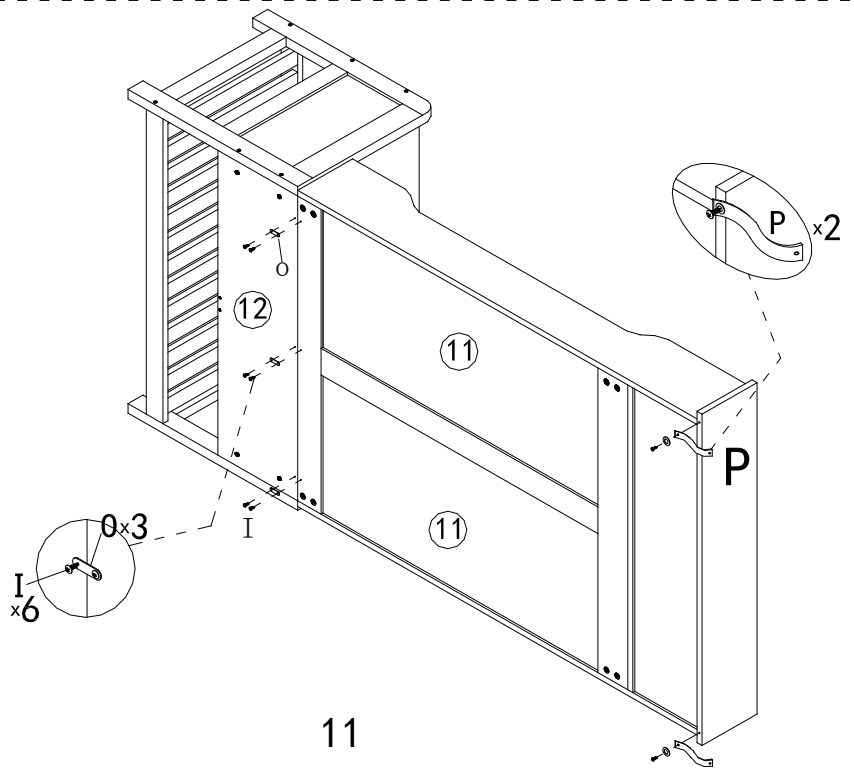

21

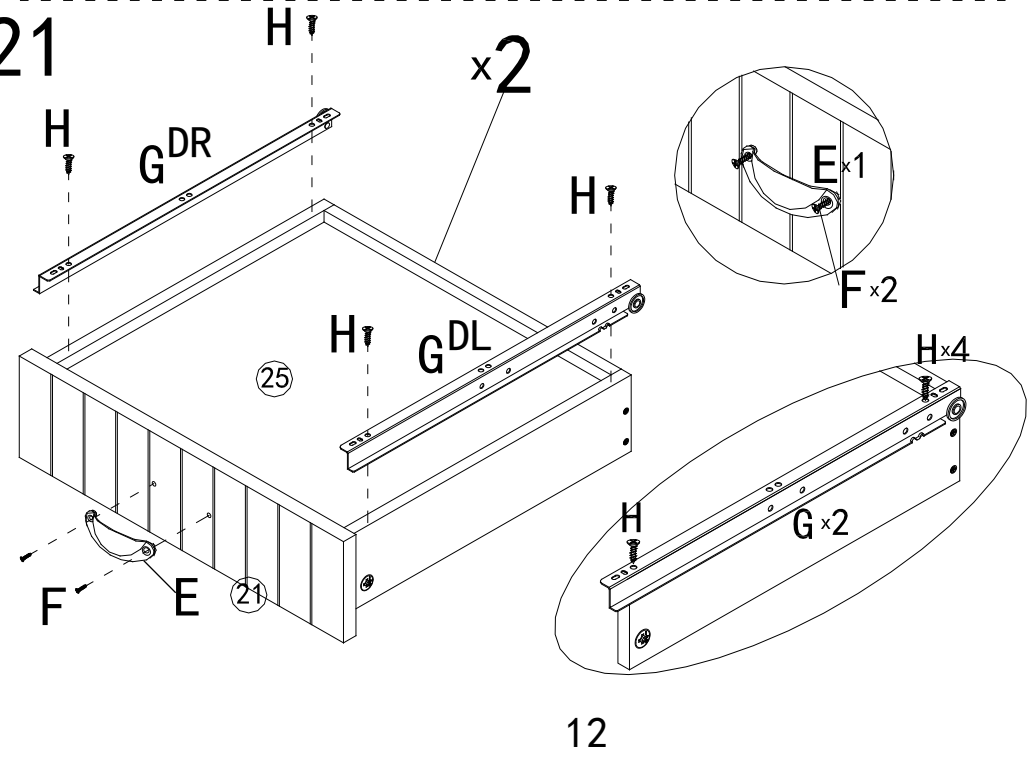

22

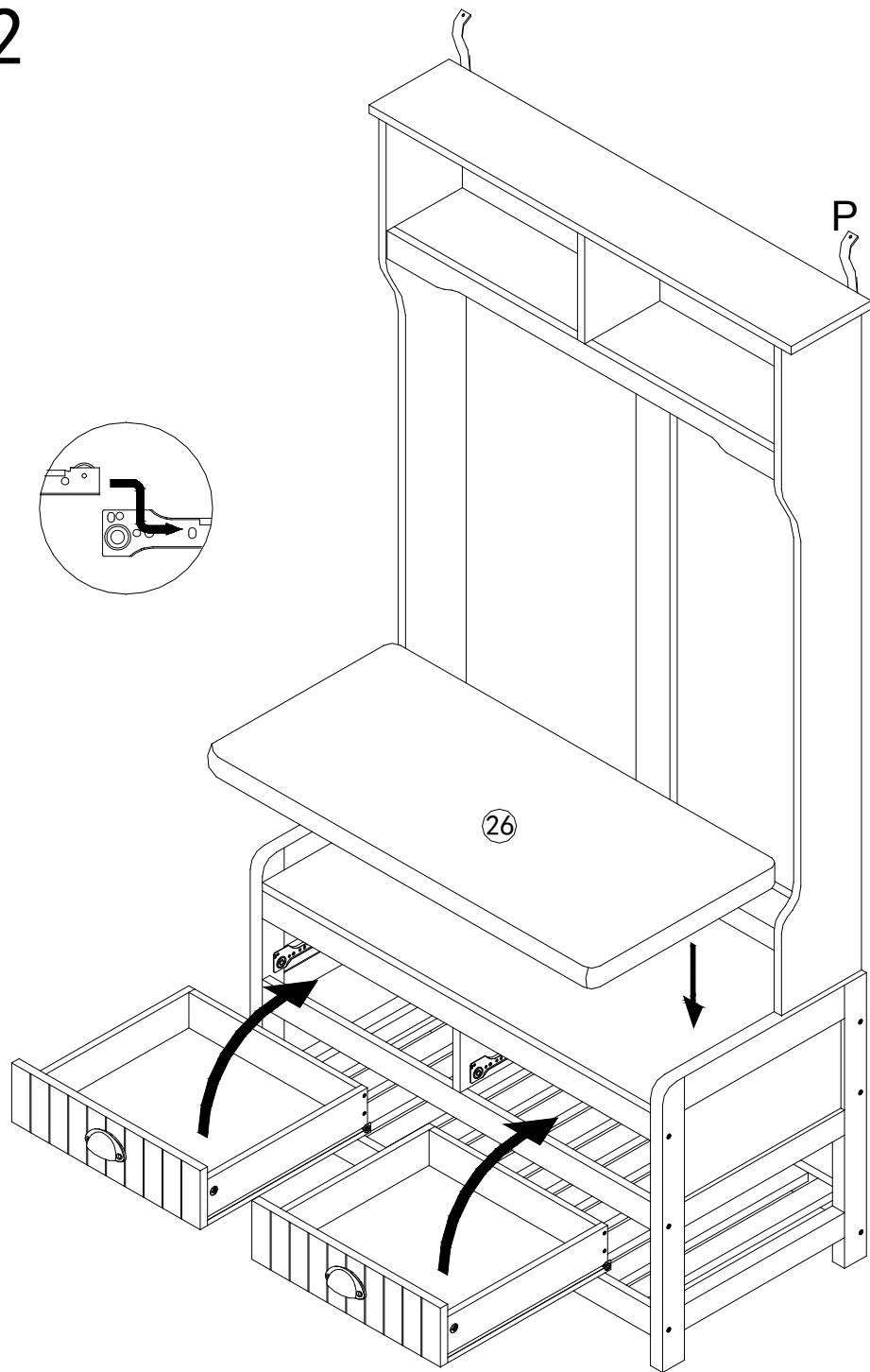

13

23

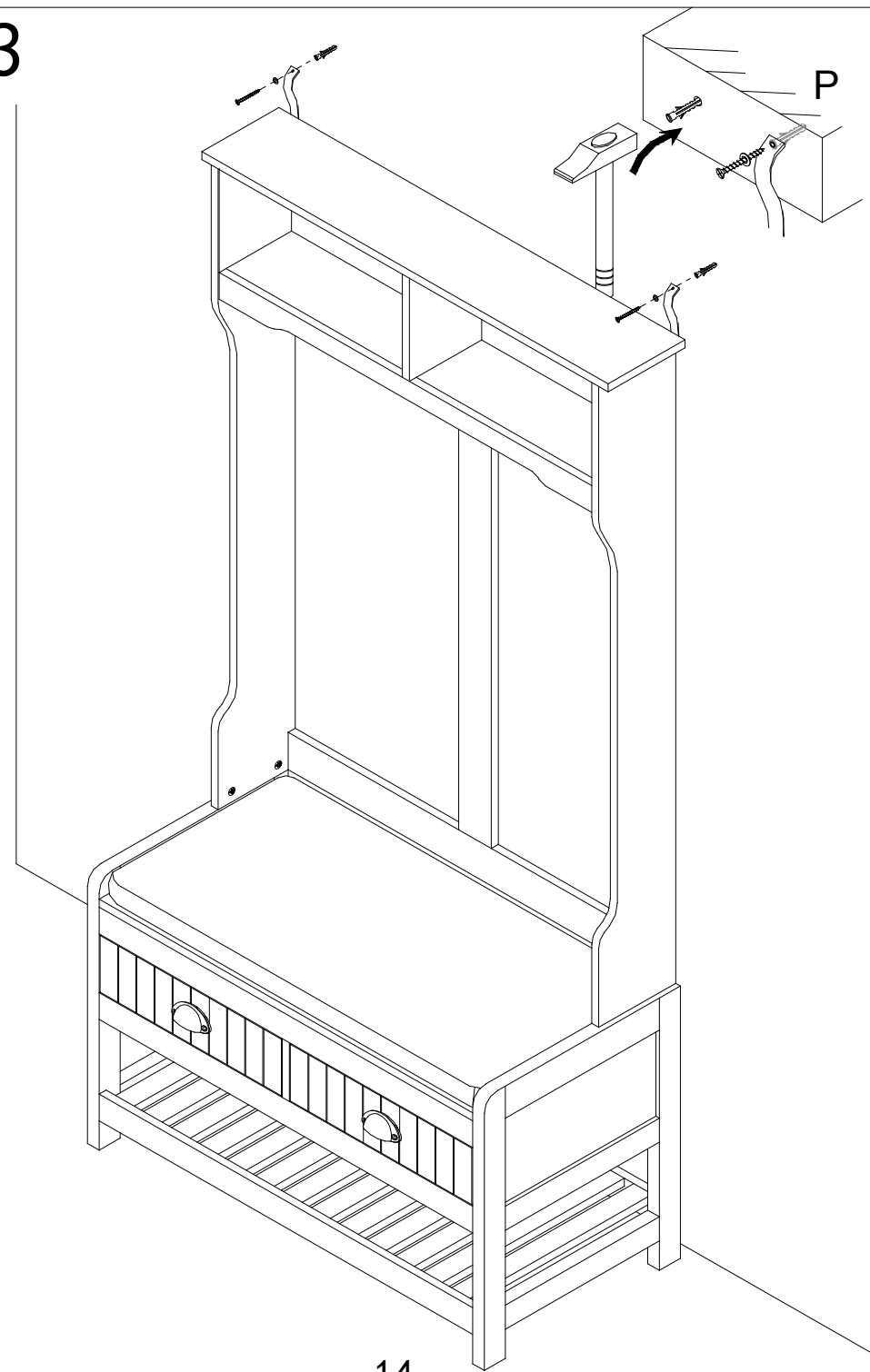

14