

# Instruction Manual

## HDPE Dinning Chair

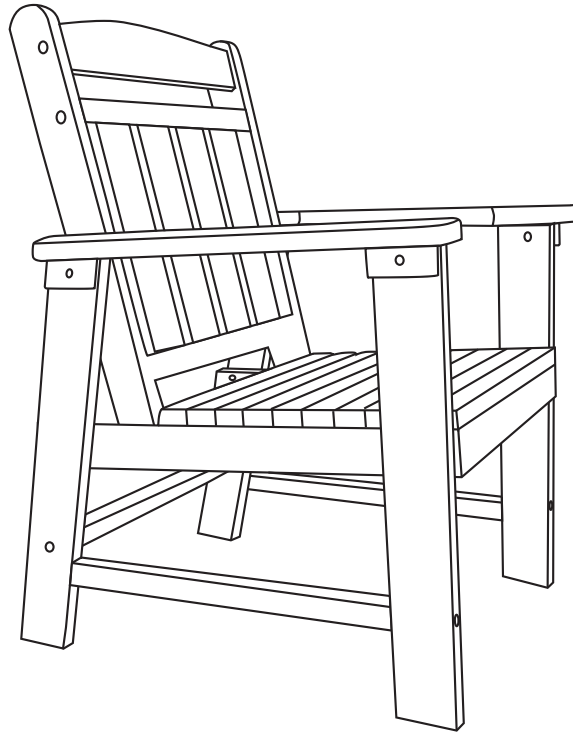

1. Please find the assembly guidelines on Page 3-6.
2. You can scan the QR code of our official website and leave a message to register for the 4-year warranty.













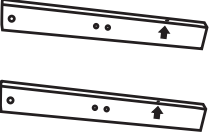
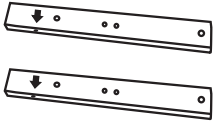

3. Defects may occur due to violent impacts during the shipping process. If you find any defective parts, please get in touch with us through Amazon messages or any of the contact methods below. We will respond within 8 hours and provide free replacement parts or other services you need.

### **Fortunecandy Inc.**

✉ customerservice@fortune-candy.com

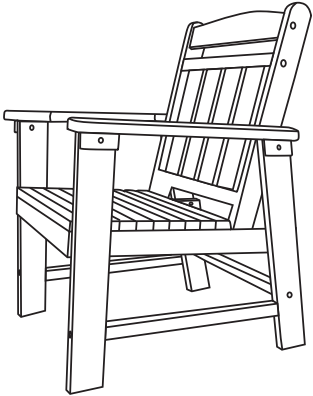
🔗 Connect with us on fortune-candy.com

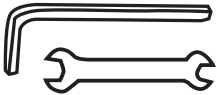
			
A x 1	B x 1	C x 1	D x 1
			
E x 2	F x 2	G x 2	H x 1
 M6*60	 M6*85	 M6*60	
① x 10	② x 2	③ x 2	
 M6*70	 M6*90		
④ x 4	⑤ x 4	Tools	

## Precautions before Assembly

1. If any parts are missing, scratched, or damaged, please get in touch with the seller or Fortune Candy customer service for a partial refund and replacement parts.
2. In each assembly step, the screws only need to be tightened 80%, which will make it easier to assemble different parts. In the last step, please tighten the screws and nuts as tight as possible.

\* We provide excellent after-sales service, which is appreciated by many buyers. Your satisfaction is our main goal.

1

4 2PCS

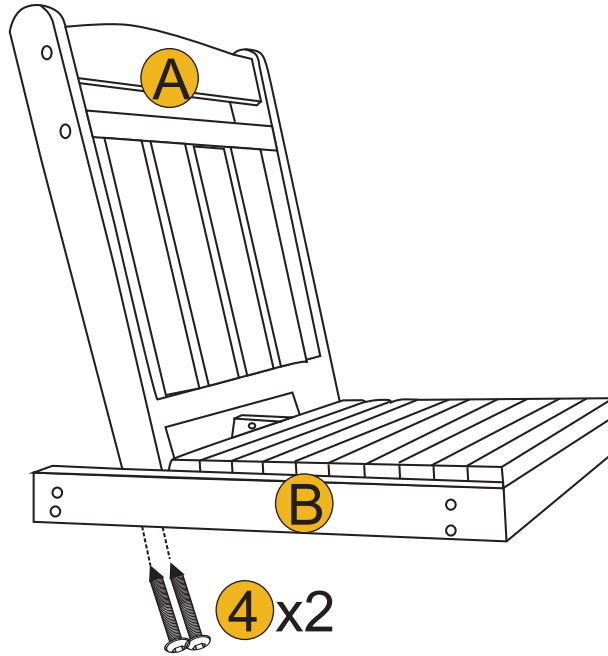

1. Assembling the back and seat. Please tighten the screws 80% only.

2

4 2PCS

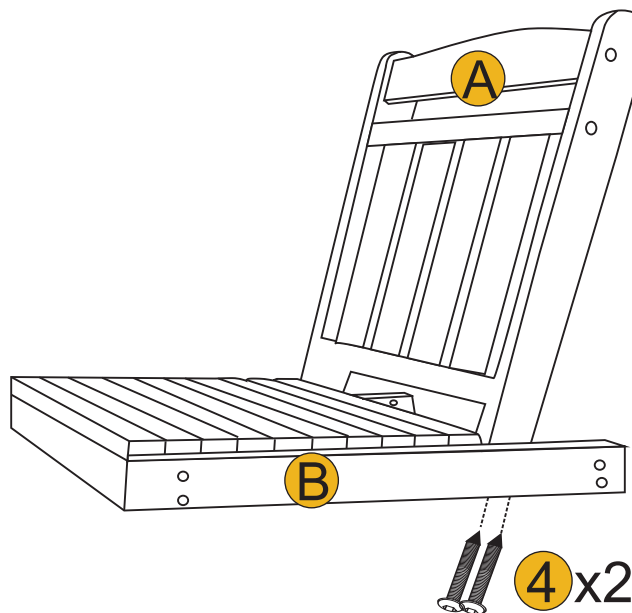

2. Part E and F have no front and back sides. Please identify the top and the bottom of Part E and F according to the screw holes.

3

1 4PCS

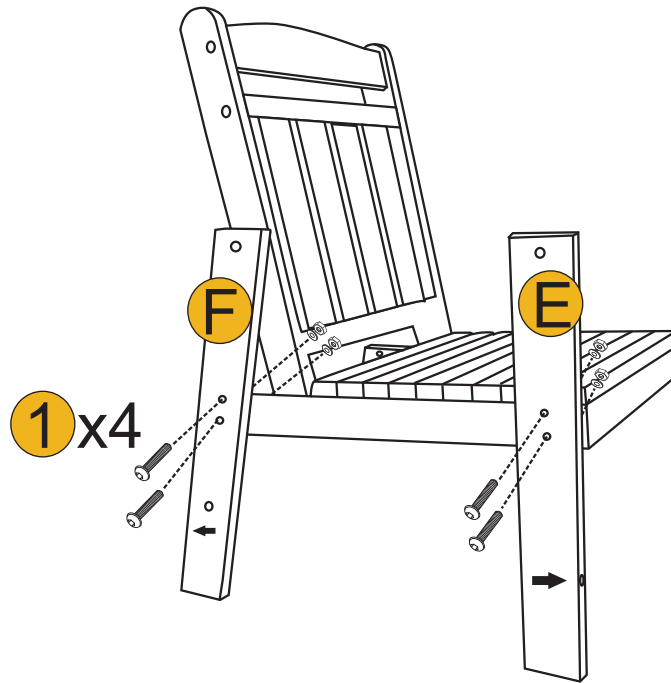

3. Part E and F have no front and back sides. Please identify the top and the bottom of Part E and F according to the screw holes.

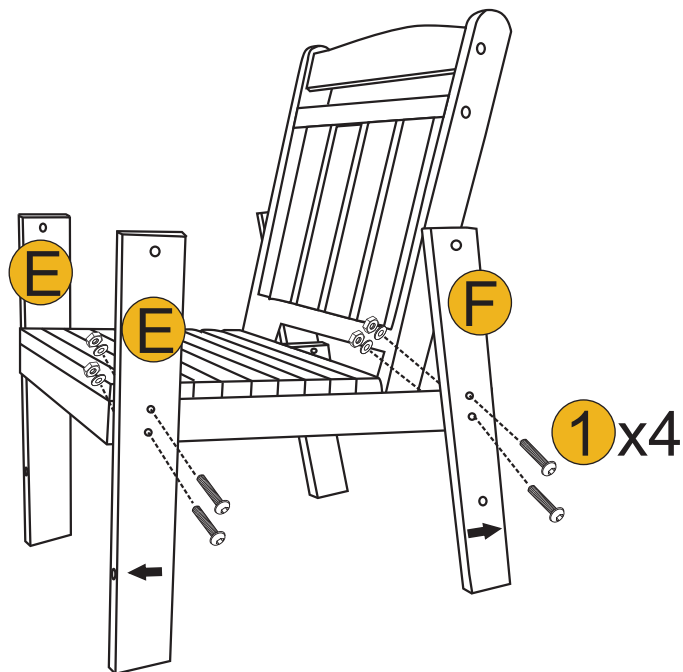

4

1 4PCS



4. Please do NOT tighten the screws.

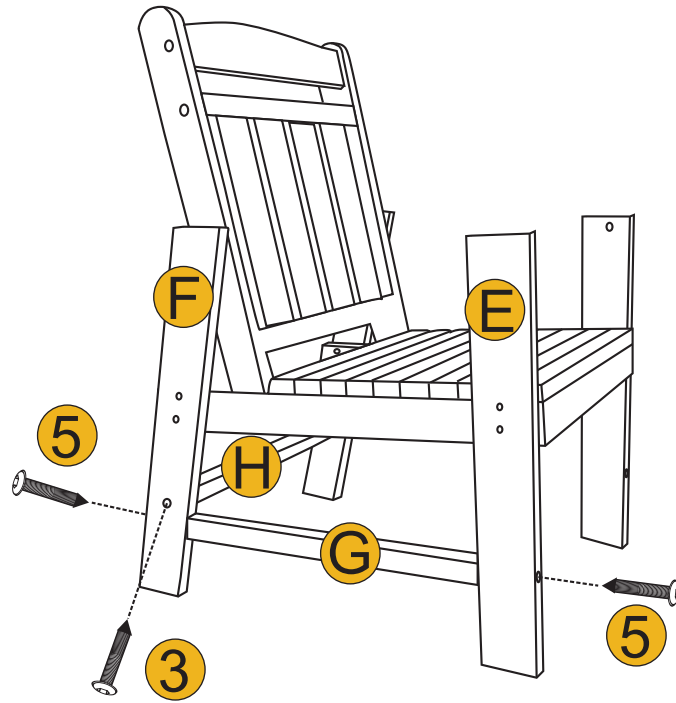

5

③ 1PCS	
⑤ 2PCS	



5. Please do NOT tighten the nuts.

6

③ 1PCS	
⑤ 2PCS	

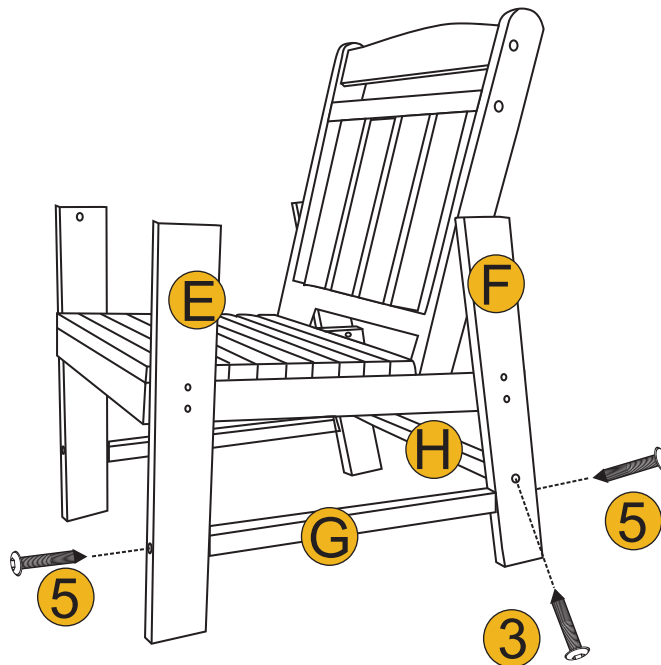

6. Assembling the armrests. You can move the parts a little to let the bolts go through the holes.

7

2 2PCS

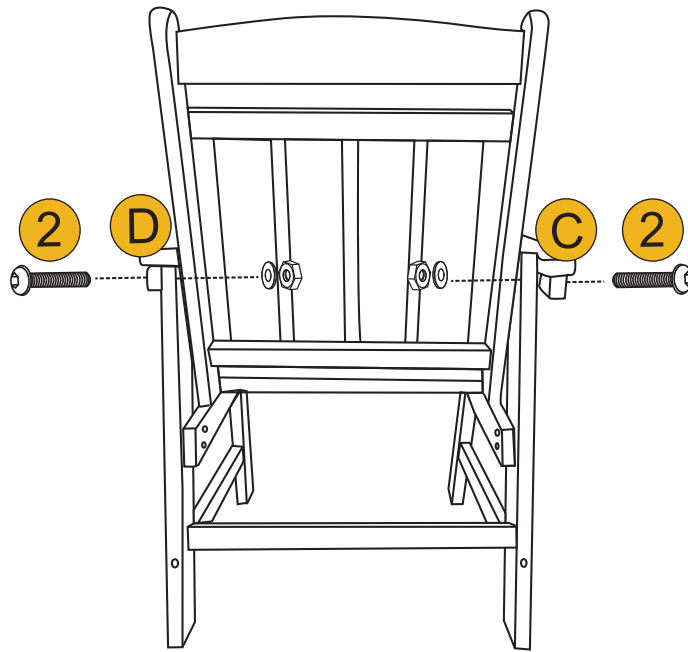
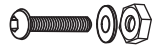

7. You can move the parts a little to let the bolts go through the holes. Please tighten the nuts to the tightest after confirming all the parts are installed correctly.

8

1 2PCS

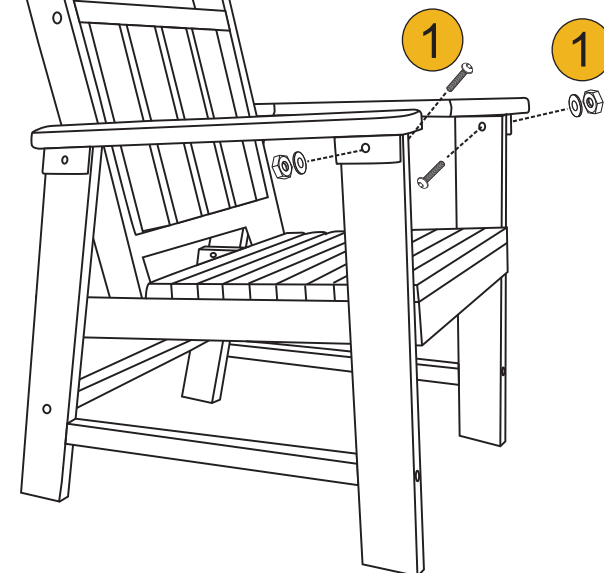

8. Now the assembly is complete.

## FAQs for This Product :

### Q: How to maintain this product?

A: Please check the nuts regularly for looseness and tighten them. This product is completely weather-resistant and very suitable for outdoor use. HDPE (High-Density Polyethylene) is the most durable material used to make outdoor furniture.

### Q: How to register for the warranty?

A: Please scan the QR code on the first page to go to our official website, <https://fortune-candy.com>, and use the online chat tool to send your order number; then we will register your product for warranty. You can also send an email to [customerservice@fortune-candy.com](mailto:customerservice@fortune-candy.com).

### Q: How to contact us to send replacement parts?

A: If you find any defects, scratches, or missing parts, the easiest way is to tell us which part you need using Amazon messages. In this way, we can find out which product you purchased and your delivery address. You can also send an email to [customerservice@fortune-candy.com](mailto:customerservice@fortune-candy.com). Please tell us your order number, shipping address, and which part is needed. No matter how you contact us, we will reply within 8 hours and give you a satisfactory solution.