

# Assembly Instructions

**Caution: You must read these Assembly Instructions before you proceed**

## Care & Maintenance



- Do not put hot items directly on furniture surface.



- Do not clean furniture with harsh cleansers or polish.



- To obtain the longest lifespan of your outdoor product minimizing exposure to direct sunlight is recommended.



- Children should not climb or jump on the furniture.



- Do not write on furniture without a padded barrier to protect the surface.



- To obtain the longest lifespan of your outdoor products, avoid extended and lengthy exposure to rain, snow, and direct sunshine. Whenever possible cover the product and /or place under patio or awnings.



- Not for commercial use. For residential use only.



- Stains may be removed with mild soap solution and damp cloth.



- Dust and pick-up spills using a clean, non-colored, lint- free cloth.

Please look into the **Seat Panel** for hardware packs.

## Chair

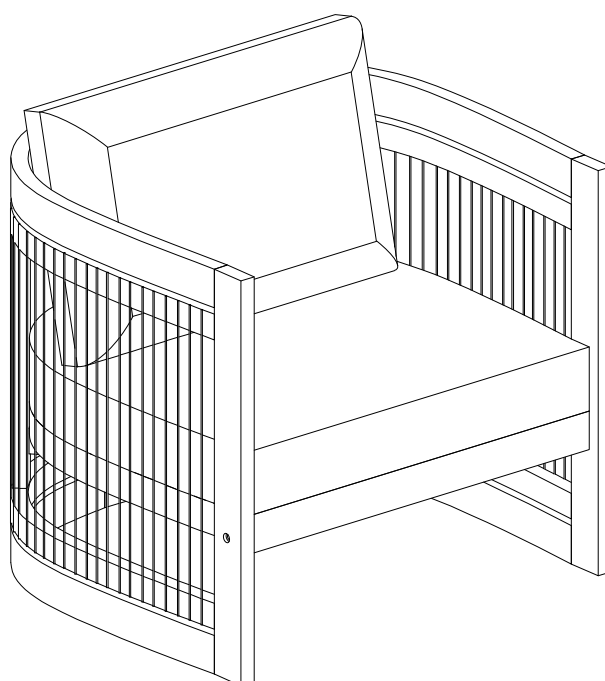

**Caution:** This Chair is NOT a TOY.





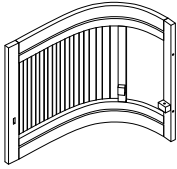
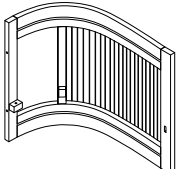
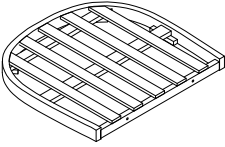
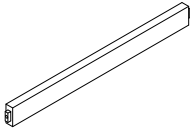
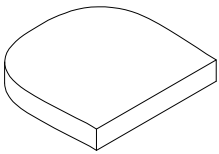
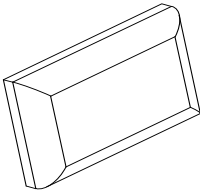

Keep your child/children at bay during the assembly process.

Whenever lifting or moving the Chair and to prevent damage to the Chair, two adults may be needed to execute these actions.

# Part List

Label	Picture	Description	Qty
A		Left Arm Panel	1
B		Right Arm Panel	1
C		Seat Panel	1
D		Support Bar	1
E		Seat Cushion	1
F		Back Cushion	1

# Hardware

No.	Picture	Description	Qty
①		Screw (M6x50mm)	3
②		Screw (M7x70mm)	3
③		Sleeve Nut (M8x18mm)	3
④		Bolt (M6x40mm)	3
⑤		Bolt (M8x90mm)	3
⑥		Allen Wrench	2

# Assembly Preparation

Before Beginning Assembly:

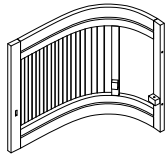

Ax1

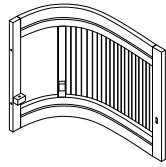

Bx1

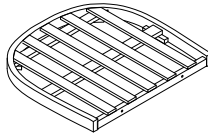

Cx1

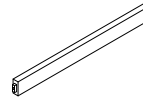

Dx1

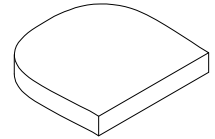

Ex1

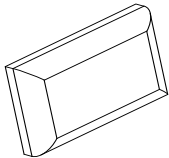

Fx1

- |   |  |    |
|---|--|----|
| ① |  | x3 |
| ② |  | x3 |
| ③ |  | x3 |
| ④ |  | x3 |
| ⑤ |  | x3 |
| ⑥ |  | x2 |



- Read instructions, cover to cover-



- Have 2 adults on hand for assembly-



- Do not assemble on flooring or carpet-



- Assemble on a clean non-marring surface (packing foam)-



- Save all packaging until finished-

# Assembly Steps

## Overview

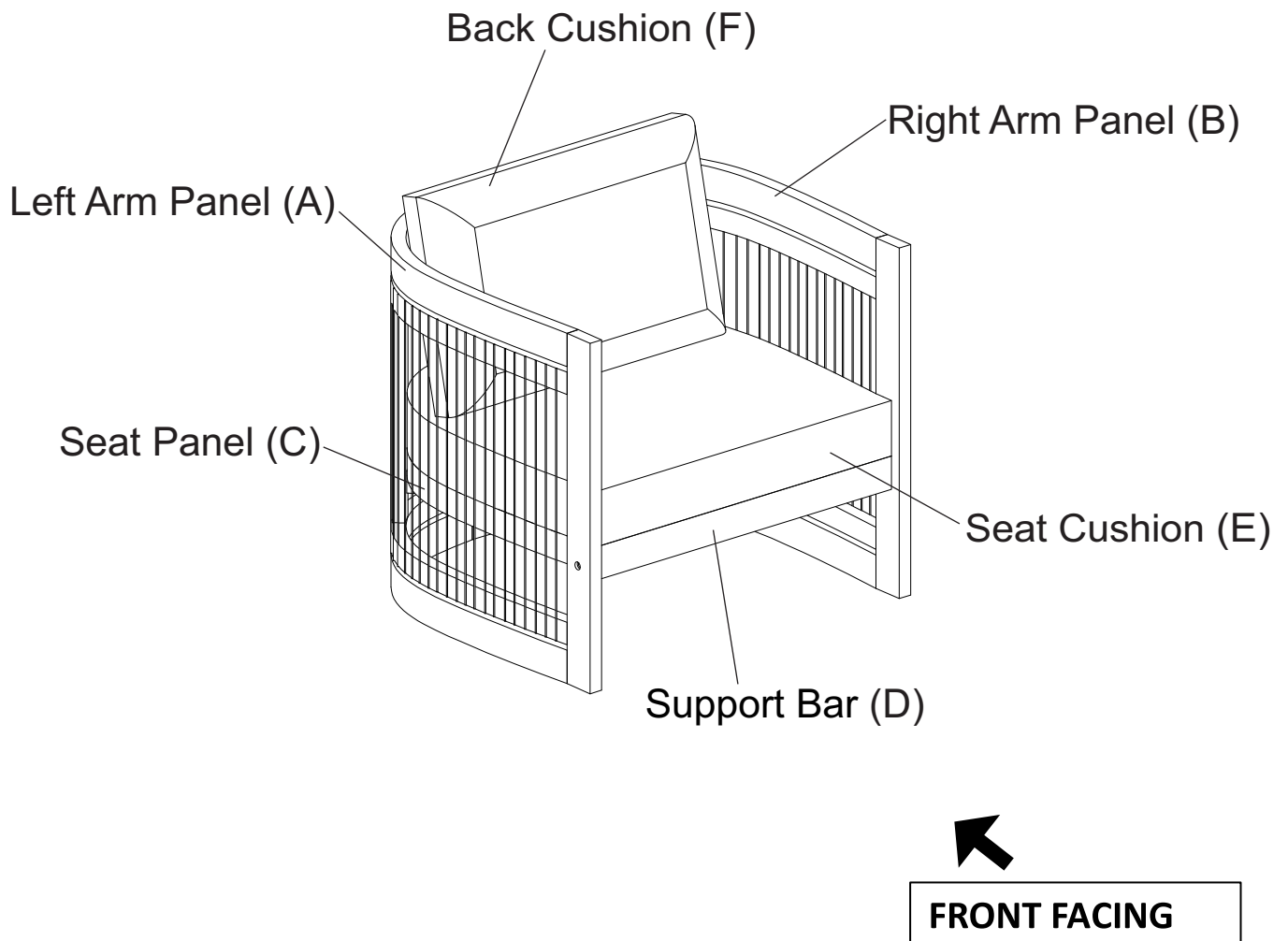

This Chair has multiple parts and may require up to 30 minutes to assemble. To give you an overview of the Chair parts, the above picture is to help you put the various parts into perspective. Please read through the instructions below to familiarise yourself with the parts and steps before assembly.

## Step 1

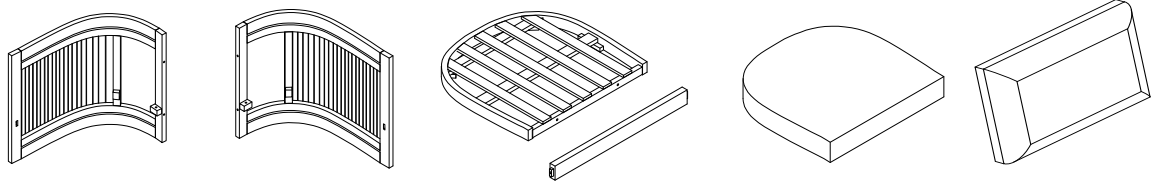

Unpack and place all parts on a clean, non-marring surface.

## Step 2

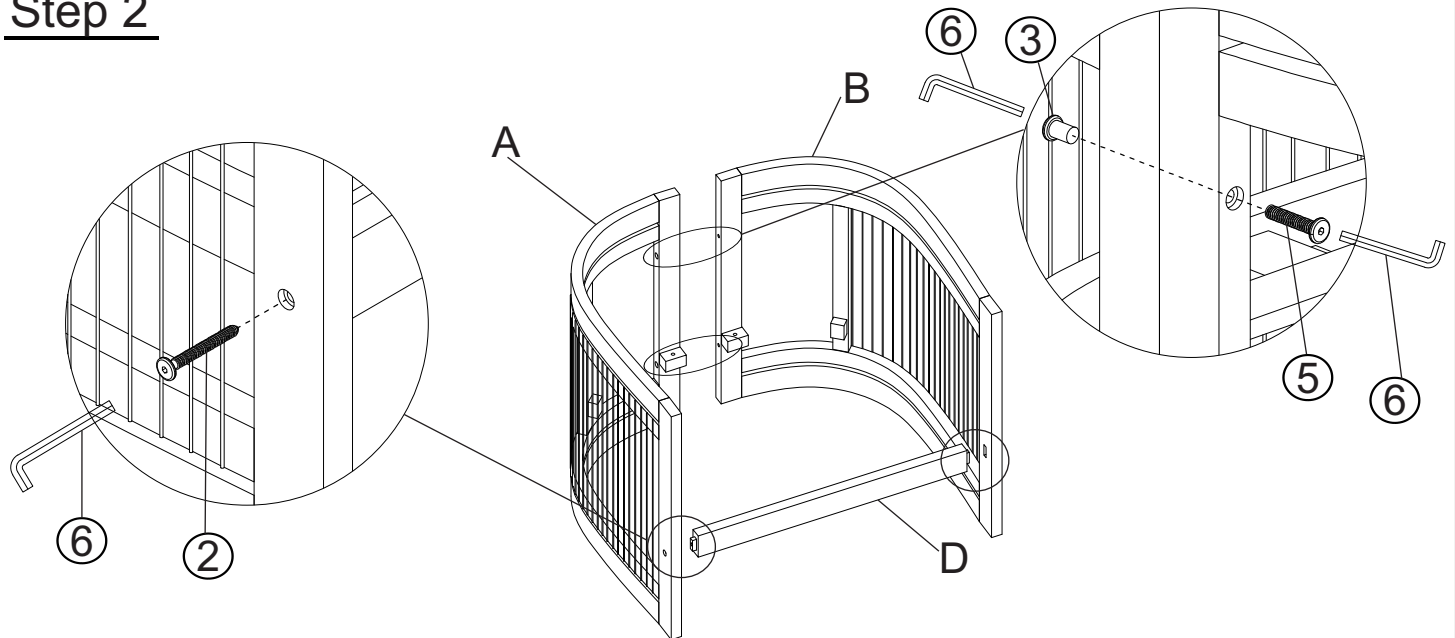

**2.** Insert the dowels of Support Bar (D) and into the mountings in the Left Arm Panel (A) and Right Arm Panel (B) using Screw (2) and Bolt (5) Sleeve Nut (3) with Allen Wrench (6).

**Do not fully tighten the Screw and Bolt.**

## Step 3

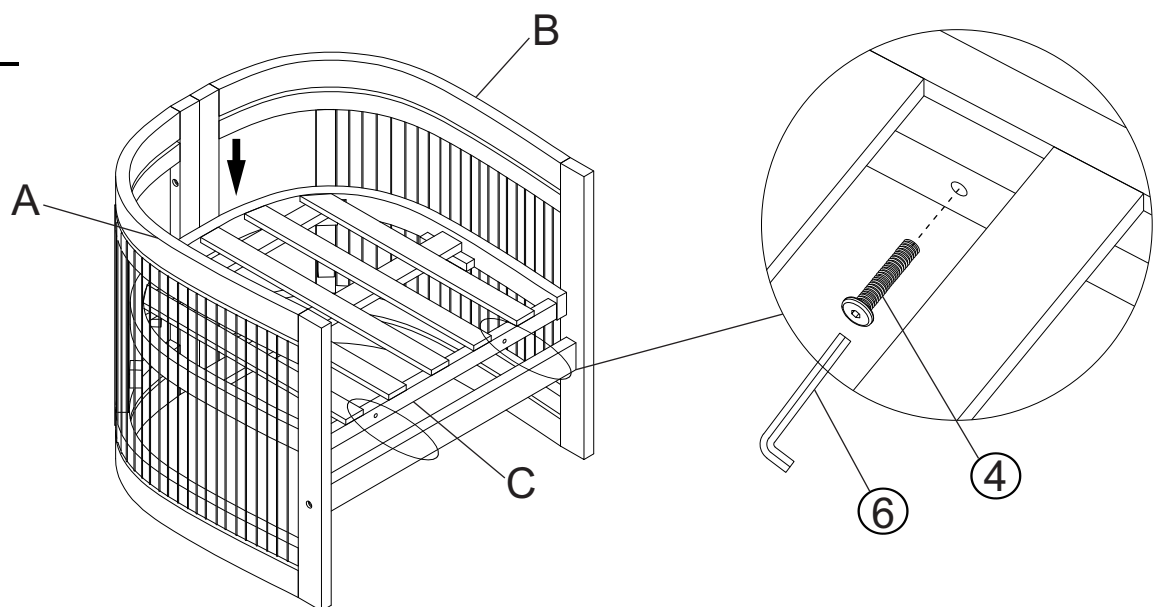

**3.** Attach Seat Panel (C) to the Chair using Bolt (4) and with Allen Wrench (6).

**Do not fully tighten the Bolts.**

## Step 4

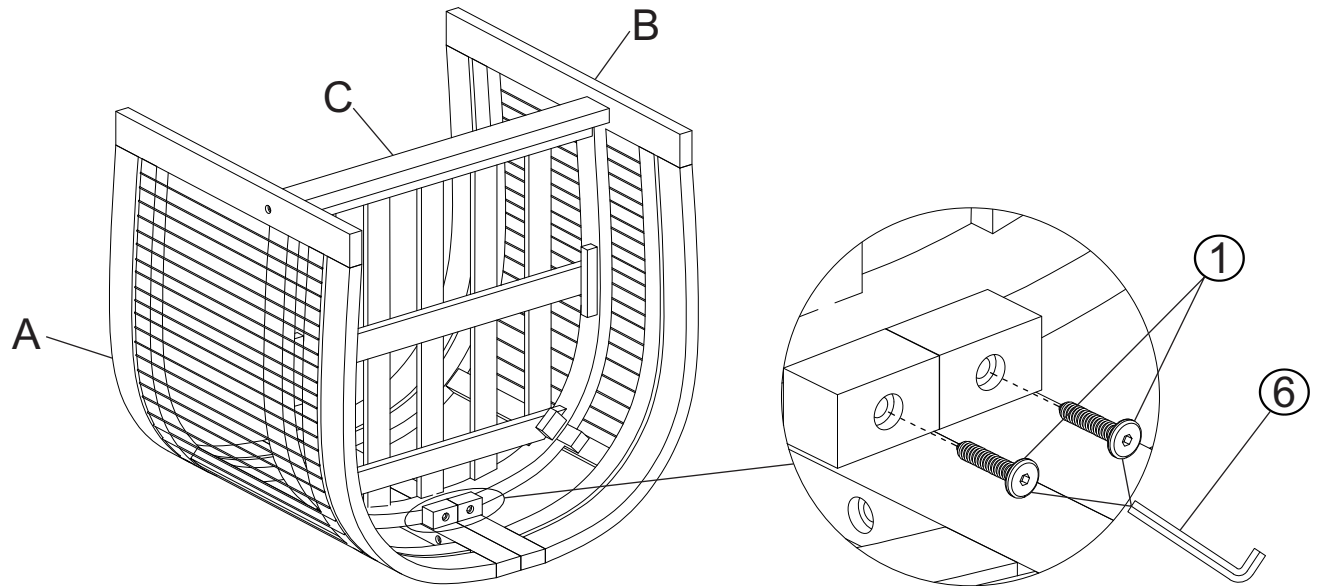

4. With the help of a friend, tilt the Chair to a 45-degree angle. Seat Panel (C) is attached to the rear support with screws (①) and with Allen wrench (⑥).  
**Do not fully tighten the Screw.**

## Step 5

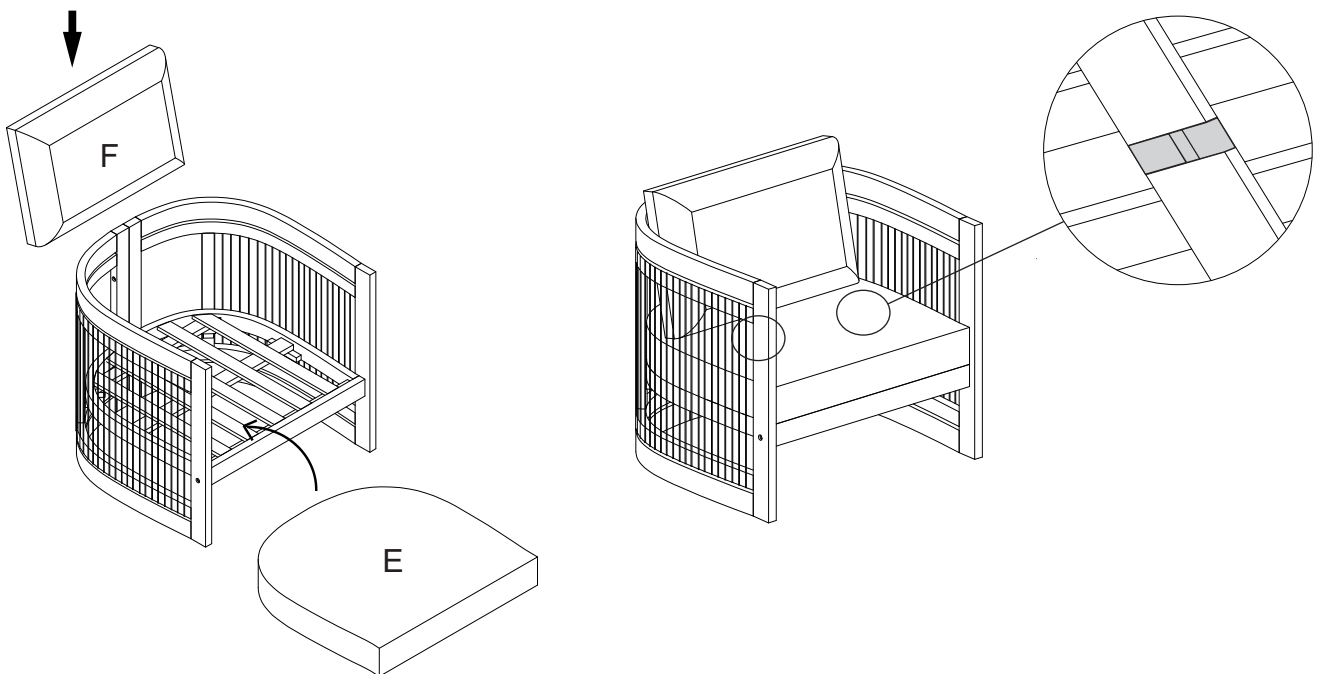

5. Place Seat Cushion (E), and Back Cushion (F) onto the Chair, and affix the magic tape straps around the Chair as shown above.  
**This Chair can only be used on a flat, level surface.**

## Step 6

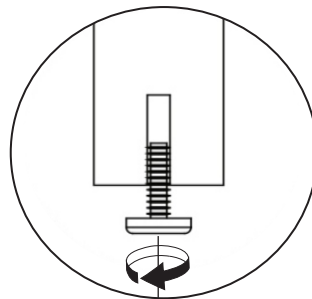
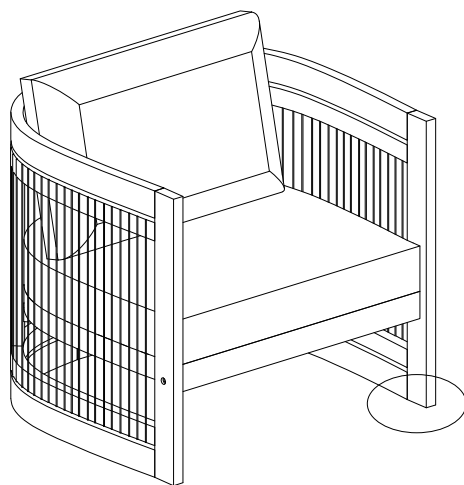

Adjust height for balance

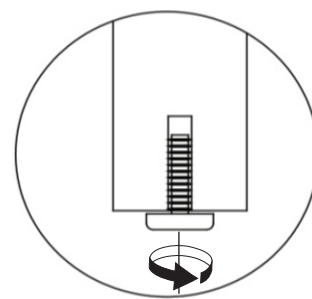

Adjust low for balance

Adjust Pre-installed Levellers  
height for balance

Inspect the Chair and make sure all parts are adequately connected.

Then EXERT pressure, floorwards onto the chair with both hand

This pressure will help align all parts at all joints.

In a sequential manner, tighten all Bolts and Screws at all joints.

**Adjust the Levellers until the Chair is level with the ground.**

**To adjust the Levellers, get assistance from an adult partner to lift/lean and hold the Chair while you are working.**