

ASSEMBLY INSTRUCTIONS



CAUTION

◆ Inspect the wire insulation for any cuts, abrasions, or exposed copper that may have resulted during shipping. If there is a defect in the wire, do not attempt installation.

◆ Before starting installation of this fixture or removal of a previous fixture, disconnect the power by turning off the circuit breaker or by removing the fuse at the fuse box.

✉ If you need further assistance, please contact us by Email: customersupport@superiordecorinc.com

TOOLS REQUIRED



Ladder



Safety glasses



Electrical tape



Phillips screwdriver



Flat blade screwdriver



Pliers

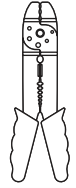

Wire strippers

HARDWARE INCLUDED

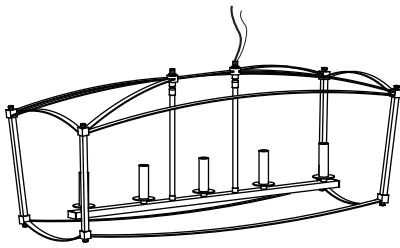

Fixture

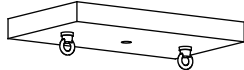

Ceiling Plate



Mounting Unit



Nut



Cap Nut

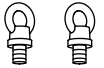

Hanging Rings

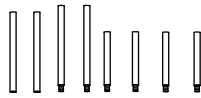

Stem(A-D)



Chains



Mounting Screws



Wire Nuts

***PARTS SHOWN MAY DIFFER SLIGHTLY PER LIGHT FIXTURE**

EXPLODED PARTS

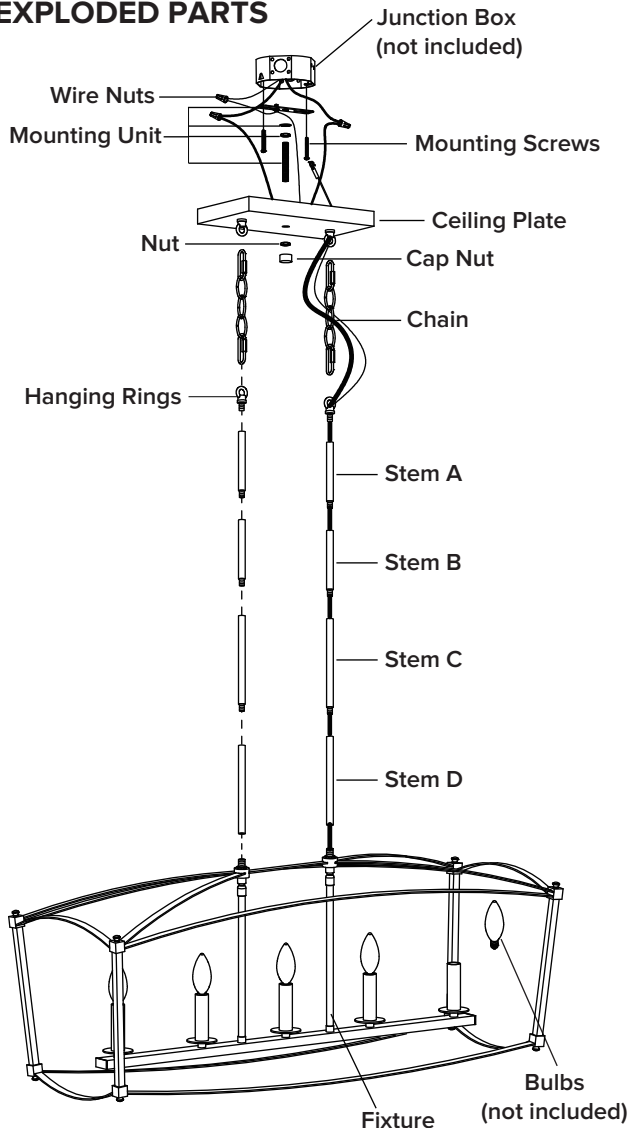

INSTALLATION

STEP 1

1. Unscrew the **nut** and **cap nut** from the **mounting unit**. Use the **mounting screws** to attach the **mounting unit** to the **junction box** (not included).

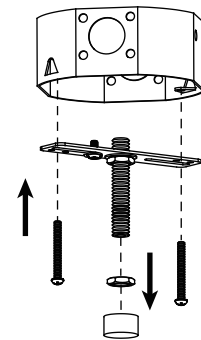

STEP 2

1. Choose the length of the **stem** you need. Weave the fixture wire and fixture ground wire through the **stem(A-D)** and **Hanging Rings**.

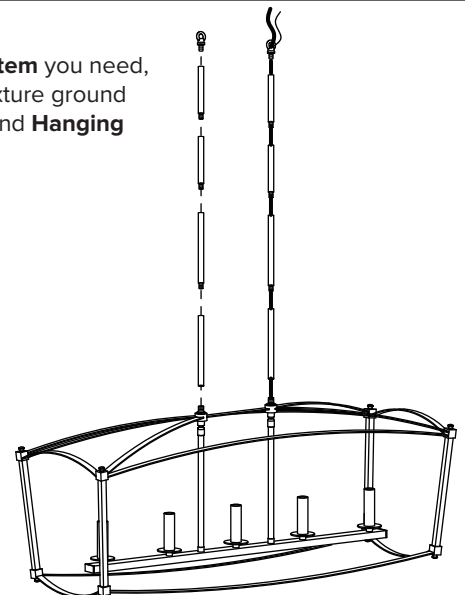

ASSEMBLY INSTRUCTIONS (INSTALLATION)

STEP 3

1. Choose the length of the **chain** you need (Open the chain using a phillips screwdriver (not included) and pliers (not included)).
2. Open the quick link. Then attach it to the **fixture finial** and **ceiling plate**. Close the quick link.

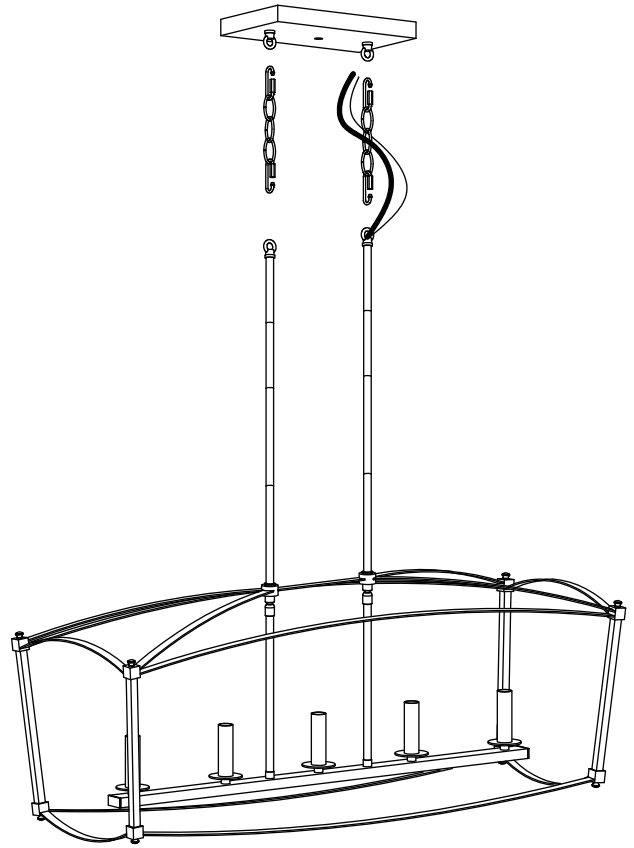
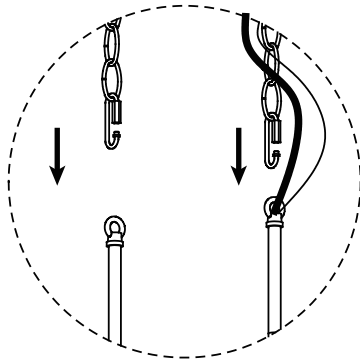
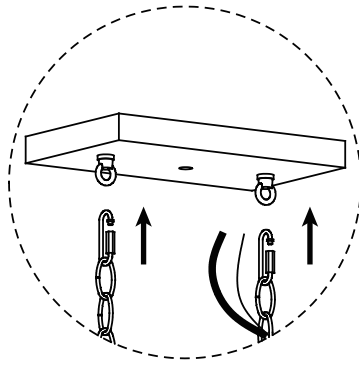
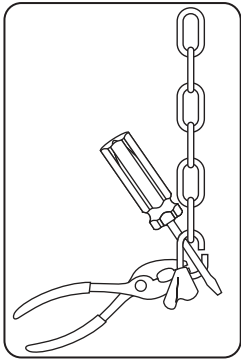

STEP 4

1. Attach the lanyards on to the mounting unit.
2. Make the electrical connection from the junction box (not included) to the **fixture**. Connect the **ground wire** to the **mounting unit** using the preinstalled green ground screw. Next, connect the live wire, neutral wire and ground wires with the supplied **wire nuts**. Secure with electrical tape.

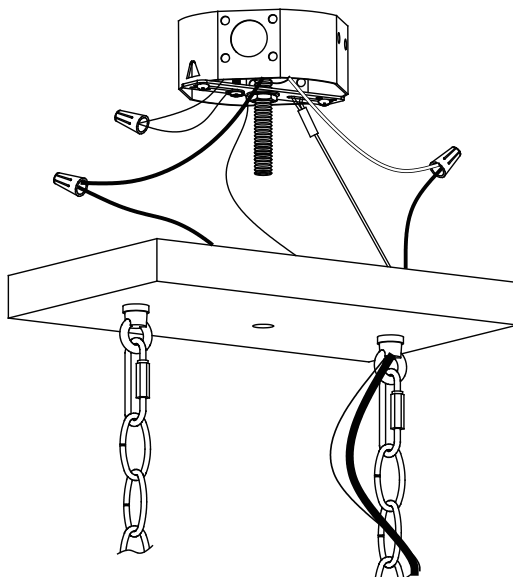
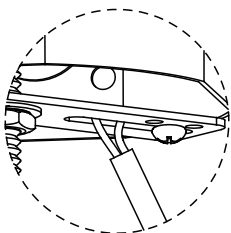
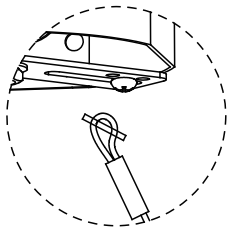
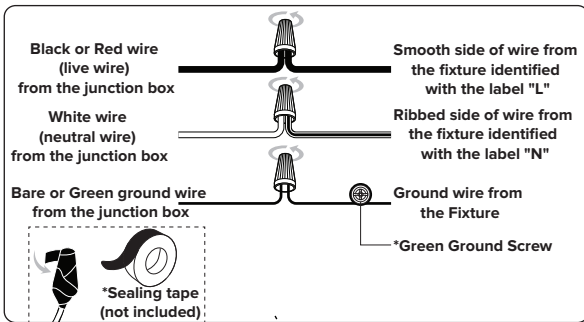

STEP 5

- Attach the **ceiling plate** to the **mounting unit** through screw holes as shown, and secure it with **nut** and **cap nut**.

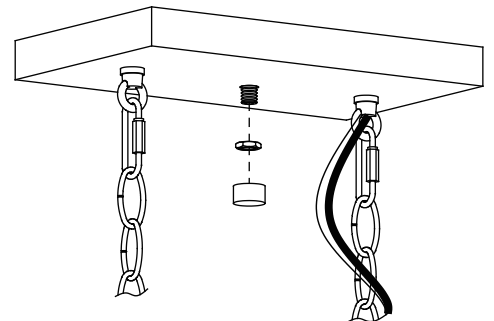

STEP 7

- Install bulbs (not included)

