

Life Gets Better With

USE AND CARE GUIDE

PV-458

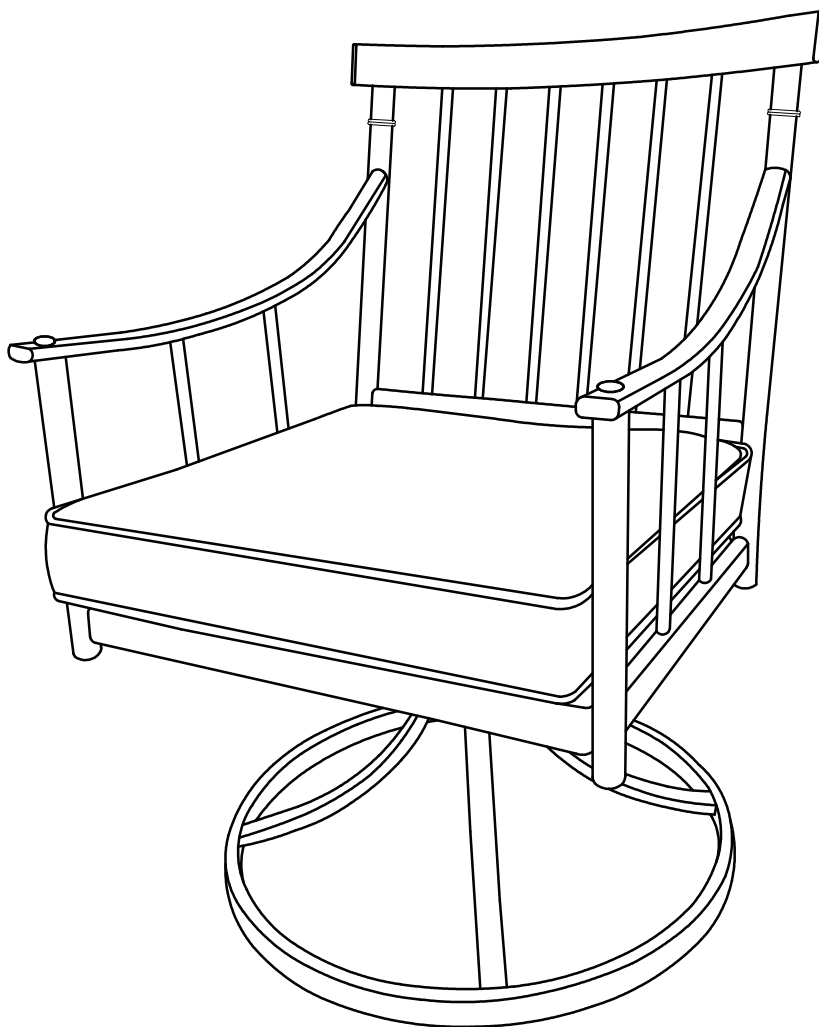









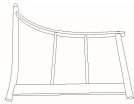
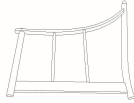
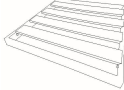
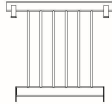



Questions, problems, missing parts? Before returning to the store,
please contact our Customer Service

service@alphamarts.com

THANK YOU

PART LIST:

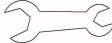
Picture	Desc	No	Qty
	Armrest	A	1
	Armrest	B	1
	Seat	C	1
	Backrest	D	1
	Pressure seat	E	1
	Chassis	F	1
	Cushion	G	1
	M6*25 Bolt	AA	4
	M6*15 Bolt	BB	2
	M6 Washer	CC	6
	M8*33 Bolt	DD	4
	M8 Washer	EE	8
	M8 Nut	FF	4
	Plate	XX	4
	M8 Socket allen	YY	1
	Wrench	ZZ	1

Step 1

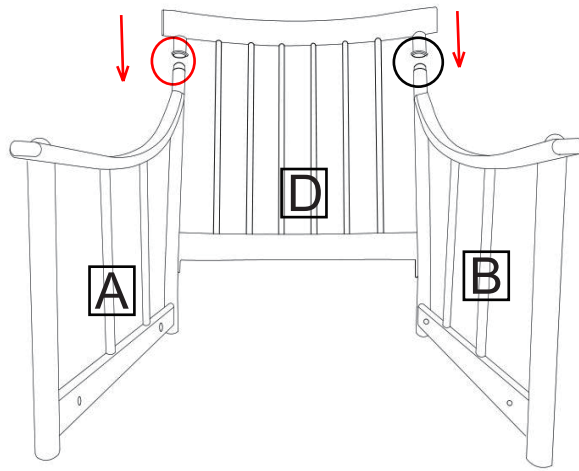

Step 2

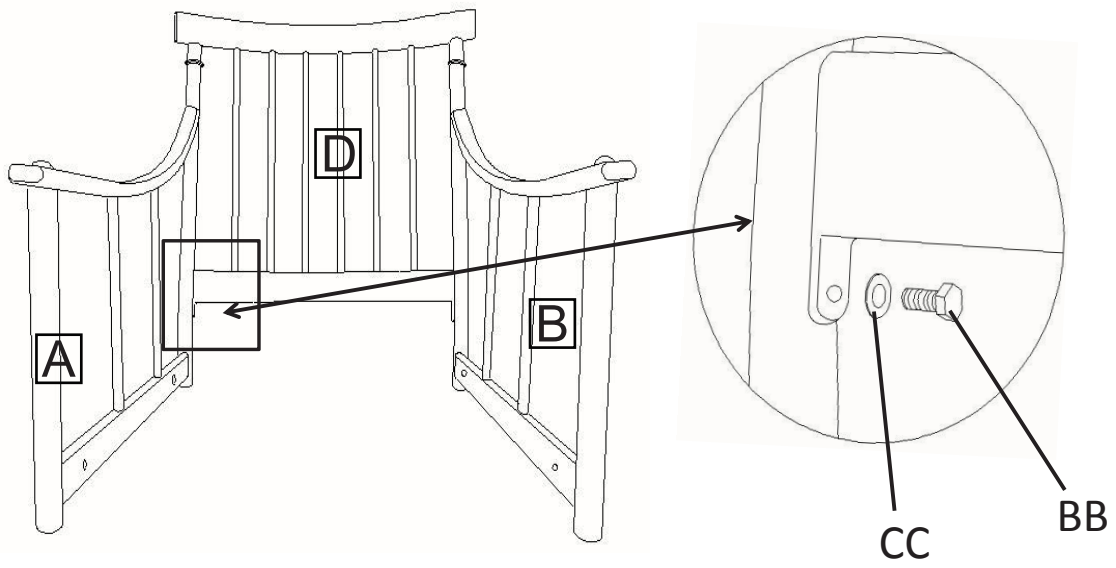

Step 3

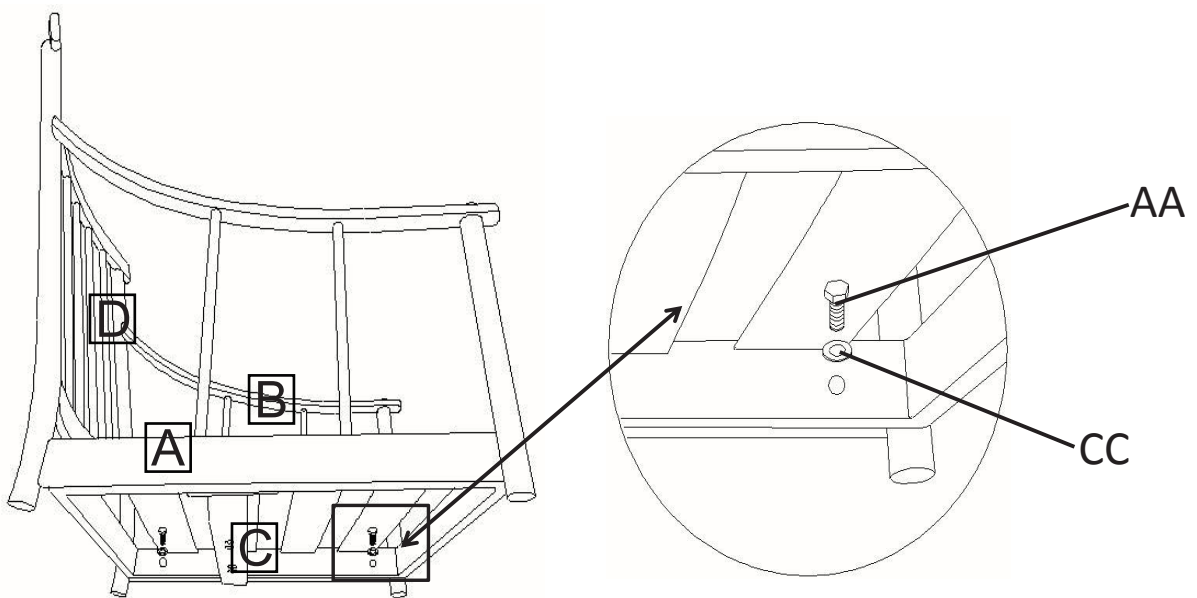

Step 4

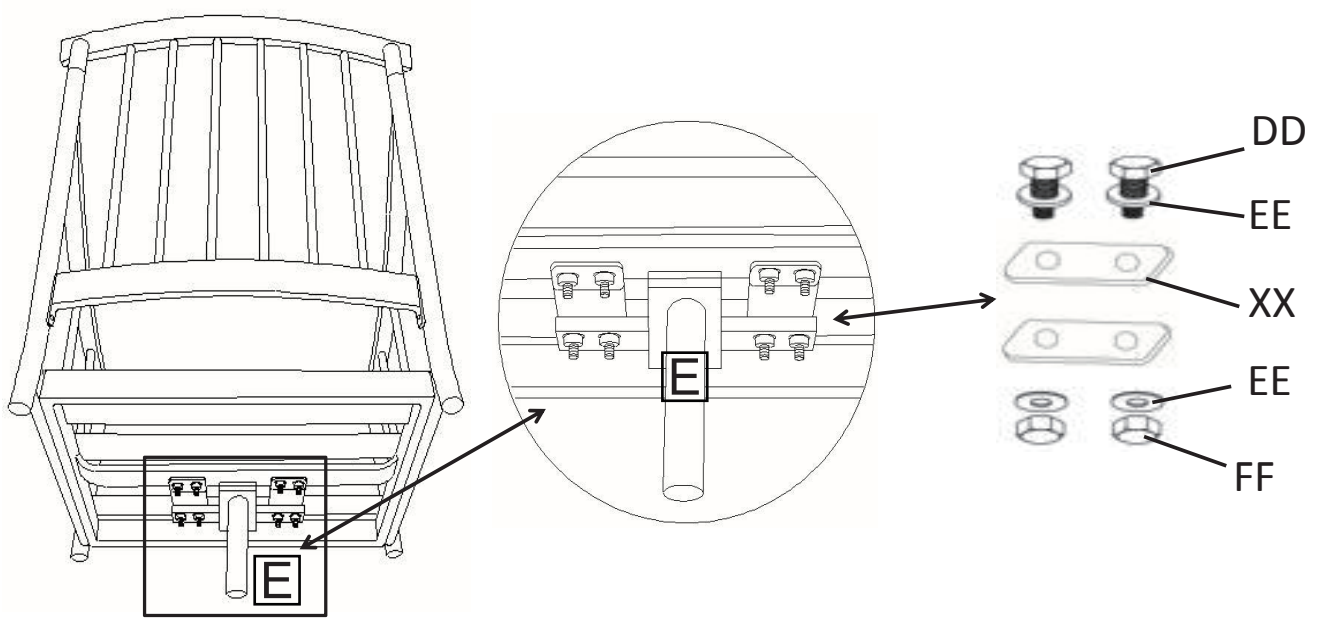

Step 5

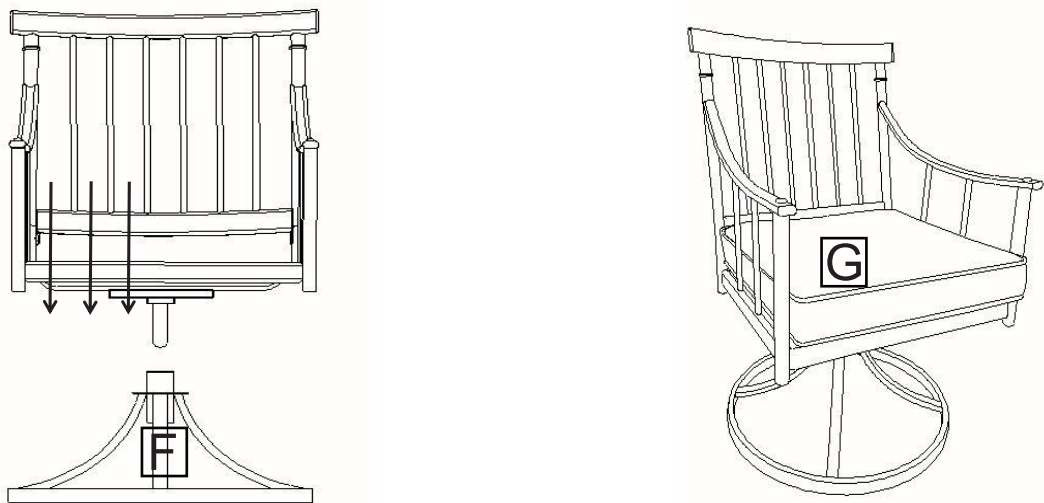

Safety Information

- Tighten each bolt firmly and properly. Do not completely tighten screws until all screws are started.
- Some parts may contain sharp edges. Wear protective gloves as necessary.
- Children under the age of 16 should not be engaged in the assembly, removal or disassembly of the product. Children under the age of 10 should be supervised by a competent adult while using this furniture.
- Please keep children out of the assembly area during assembly.
- This set is heavy, and may require two adults for safe assembly.
- Never use this product as a support. Do not shake, lean, or climb on the product at any time.



DANGER : Do not allow children to play with plastic wraps or small parts to prevent potential choking hazard.



CAUTION: Read all the instructions before assembly. Failure to do so may result in faulty assembly and potential injury!

Warranty

LIMITED WARRANTY

This warranty is a limited warranty, and applies to the original purchase is required. This is a residential warranty and does not apply to commercial use. This collection carries a (1) year limited warranty and is valid from original date of purchase to the original owner (proof of purchase required).

WHAT IS COVERED

We warrant the frame to be free of Manufacturing defects to the original purchaser for one year.

WHAT IS NOT COVERED

This warranty does not cover commercial use, hardware, acts of nature, fire, freezing and abusive.

In addition, purchased parts are not covered under this warranty.

We reserve the right to make substitutions with similar merchandise, if the model in question is no longer in production.

For a copy of our full limited warranty, please contact our customer service team below.

Care and Cleaning

- Clean the furniture frame with a wet towel using a mild soap and water solution, dry completely with a soft towel.
- Clean the cushions and the sling seat material with a mild solution of soap and water. Hang cushions to drip dry completely. It is recommended that cushions be stored in a dry area during rain and if they are not in use and indirect sunlight. Do not machine wash or dry. Do not use bleach or strong solvents to clean any of your patio furniture. It will harm both fabrics and metal finishes.
- Cushion should not be used when using oils, lotions and other chemicals such as chlorine or repeated exposure to extreme weather conditions (including heat), which may cause permanent discoloration to the fabric.
- To maintain and protect the furniture, always cover it with an outdoor furniture cover or store in a safe dry area when not in use for long periods of time.

Questions, problems, missing parts? Before returning to the store
please contact our Customer Service

service@alphamarts.com

1-877-606-2818
