



### CALL US FIRST

Do not return to the store. For assistance with your installation, or for additional product information, call our customer service department at **1-866-635-4968**, or visit [www.odl.com](http://www.odl.com).

### WATCH THIS VIDEO FIRST

Watch the ZEEL® Frame and ODL Doorglass installation video at [zeel.odl.com/install](http://zeel.odl.com/install) to confirm the assembly process.

## INSTALLATION INSTRUCTIONS FOR DOORGLASS WITH ZEEL® FRAME

### Transform Your Door. It's Simple.

A beautifully designed entry sets the stage for the rest of your home.

It's a wise investment that improves the look and value of your home and adds beauty to everyday living.

ODL® Doorglass is simple to install. No mess. No caulking. No delays in ordering.

*NOTE: These instructions reference a 22x36 inch doorglass unit. Your doorglass may be a different size and style.*

*Regardless, the process will be the same referenced with these instructions.*

#### HAVE A HELPER SUPPORT THE GLASS

### MEASURE

FITS STANDARD SIZE DOORS



### REMOVE

THE EXISTING DOORGLASS



### REPLACE

WITH NEW DOORGLASS



# INSTALLATION INSTRUCTIONS FOR DOORGLASS WITH ZEEL® FRAME

FOR 1-3/4" THICK DOORS

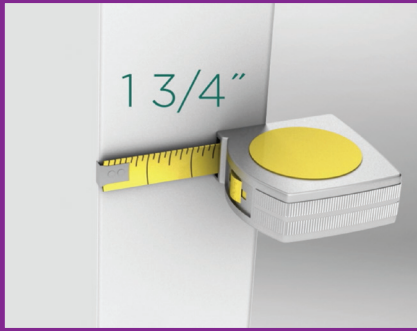

## STATEMENT OF INTENDED USE

ODL® Doorglass panels are for use in 1-3/4" thick residential steel and fiberglass doors.

**THEY ARE NOT DESIGNED FOR USE IN WOOD DOORS,** doors that do not have rigid steel frames, or as windows in a wall.

ANY MISUSE OR INSTALLATION OTHER THAN STATED WILL VOID THE WARRANTY.



## CAUTION

When working with glass and frames, care should be taken. ODL Doorglass is made of tempered safety glass but **should be carefully supported at all times.**

The smaller sized glass can be installed vertically, but we recommend that the 22" x 64" glass be installed with the door off the hinges and lying down.

Because the frames and glass are heavy and of an awkward size, **two installers may be required** to remove the old glass from the opening and lift the ODL Doorglass.

## TOOLS YOU WILL NEED



## TOOLS

### FIND A HELPER

- Rubber mallet
- Table or other flat & stable work surface area larger than Glass/Frame Unit
- Safety Gloves
- Safety Glasses
- Dry Wall Screw (size optional)
- Power Screw Driver with Phillips Head Bit
- Putty Knife
- Window Cleaner
- Tape Measure
- Pencil
- Painter's Tape
- Drop Cloth

## MEASURE TWICE FOR ACCURACY



# BEFORE YOU BEGIN

- Keep your current doorglass and frame until the ODL Doorglass and ZEEL® Frame unit is completely installed.
- Before you begin the installation process, become familiar with the Glass/Frame unit and these instructions, see page 5.
- It may be helpful to watch the ZEEL® Frame and doorglass installation and assembly video to confirm the process at [zeel.odl.com/install](http://zeel.odl.com/install).

**NOTE:** These instructions reference a 22x36 inch doorglass unit. Your doorglass may be a different size and style. Regardless, the process will be the same referenced with these instructions.

## REPLACEMENT GLASS INSTALLATION INSTRUCTIONS

### A MEASURE THE EXISTING OPENING

**ODL Doorglass is intended to be used as a replacement product.** Existing doorglass must be removed prior to installing this product.

**Removal may make the existing doorglass or sidelight unusable.** If you have questions or concerns, consult with an ODL Customer Service Representative at 800.253.3900 for help.

**MEASURE THE THICKNESS** of the existing door. ODL Door-glass is designed to **FIT DOORS THAT ARE 1-3/4" ± 1/16" THICK.**

#### FOR 1-3/4" THICK DOORS



**MEASURE THE WIDTH AND HEIGHT** of the existing doorglass. If the measurements correspond to the chart, ODL Doorglass will fit your door.

#### WIDTH AND HEIGHT



Doorglass Size*	Maximum width of existing frame	Maximum height of existing frame
22x36	24"	38"
20x36	22"	38"
22x64	24"	66"
20x64	22"	66"
22x48	24"	50"
8x36	10"	38"
8x64	10"	66"
7x64	9"	66"
8x48	10"	50"



# REPLACEMENT GLASS INSTALLATION INSTRUCTIONS

## B REMOVE FRAME & GLASS

### A. LOCATE SCREWS AND REMOVE THEM

Old paint, putty, or caulk may need to be removed from the screw plugs first. **REMOVE ALL SCREW PLUGS AND ALL ATTACHMENT SCREWS.**

WE RECOMMEND THAT THE 22"X 64" GLASS BE INSTALLED WITH THE DOOR OFF THE HINGES AND LYING DOWN

### USE DRYWALL SCREW TO REMOVE SCREW HOLE PLUGS



### HAVE A HELPER SUPPORT THE GLASS



### B. REMOVE INNER FRAME

Once the screws are removed, have a helper stand on the outside of the door and hold the frame. **REMOVE THE INNER FRAME.**

### CAREFULLY PRY FRAME LOOSE



### C. LOOSEN OUTER FRAME

Apply painter's tape to protect the outside surface. **INSERT THE PUTTY KNIFE** between the outer frame and the door to break the old caulk seal.

**TIP:** Spray window cleaner around outer frame's edge to help release caulk.



### REMOVE EXISTING DOORGLASS



### D. REMOVE EXISTING DOORGLASS

While wearing safety glasses and gloves, **GENTLY REMOVE THE EXISTING GLASS.**

### REMOVE EXCESS CAULK & DIRT



### E. CLEAN & PREPARE DOOR SURFACE

After the doorglass has been safely removed, **CAREFULLY SCRAPE** any old or excess caulk and dirt from the inside and outside openings.



# ZEEL® FRAME ASSEMBLY INSTRUCTIONS

Fig. A.

**INNER FRAME** (goes inside your home)

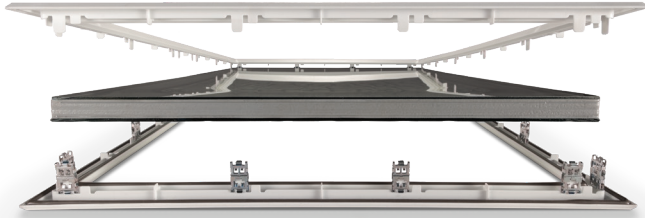

**OUTER FRAME WITH CLIPS** (goes outside your home)

Fig. B.

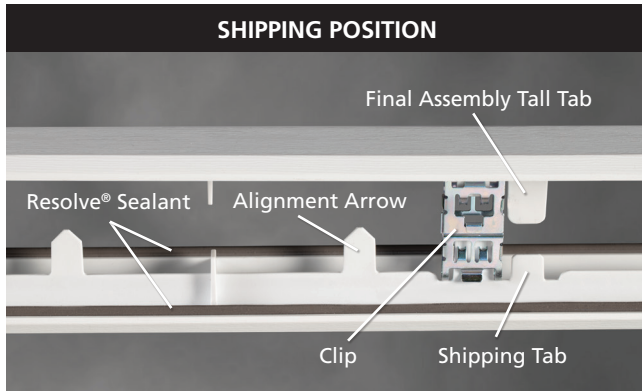

Fig.C

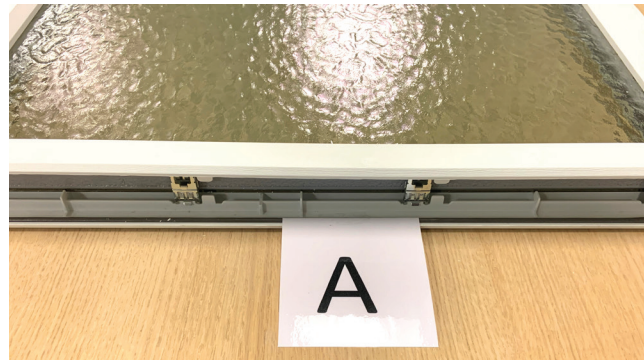
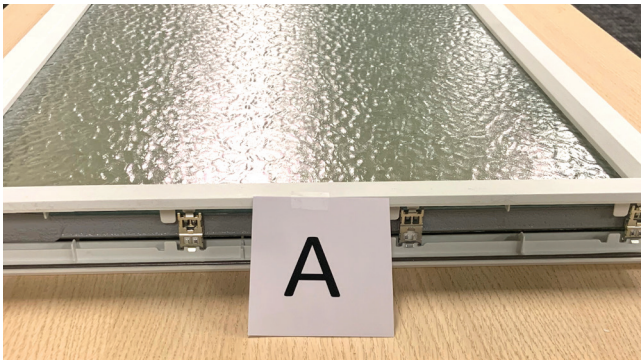
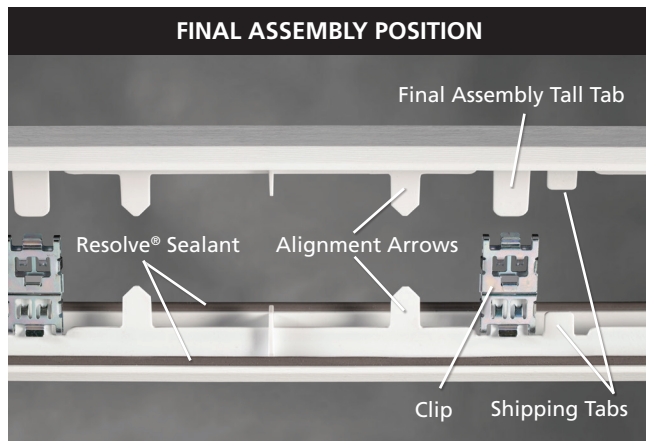

Fig. D.



## BEFORE YOU BEGIN REVIEW THE FOLLOWING AND BECOME FAMILIAR WITH THE GLASS/FRAME UNIT:

- Keep your old doorglass and frame until the ODL Doorglass and ZEEL® Frame unit is completely installed.
- ZEEL's innovative clip system is designed for easy and more secure installation and for a one-time use. It is important to ensure the clips are aligned prior to locking clips. Once engaged the clips cannot be disengaged.
- Two people are required to install.
- Become familiar with the Glass/Frame Unit (see Fig. A and Fig. B) and these instructions before beginning. This will be very helpful. *To assist, before you begin, tape a small note "A" at one end of the inner frame and another note "A" at the other end of the outer frame. (see Fig. C) In step 4 these notes should be on the same end.*
- *Note how the frame is seated on the glass for shipping. Shipping Tabs are short and Final Assembly Tabs are long. The Outer Frame has Clips attached. (see Fig. B)*
- *For the Final Assemble (Step 4) the longer tabs of the Inner Frame will be aligned with the Clips of the Outer Frame and the large arrows from both frames will be aligned. (see Fig. D)*
- You may wish to watch the ZEEL® Frame and doorglass installation and assembly video to confirm the process at [zeel.odl.com/install](http://zeel.odl.com/install).

## 1. GETTING STARTED

- Grasp each end of the Glass/Frame Unit and remove from packaging.
- Have each person grasp one end of the unit. Do not lift in the middle, the frame will flex away from the door glass.
- Place Glass/Frame Unit on a table or other flat, solid and stable surface that is larger than the Glass/Frame Unit, with the Outer Frame face down. Outer Frame has clips attached. (see Fig. A & B)

Fig. 2-A.



Fig.3-A



Fig.3-B



## 2. REMOVE INNER FRAME

- The Glass/Frame Unit is packaged with the frame in the shipping position. Short tabs of the Inner Frame are engaged in the Clip of the Outer Frame. (see Fig. B).
- Gently loosen the short tabs out of the Clips, working around the frame until all of the tabs are out of the Clips. (see Fig. 2-A)
  - Important: Do not pull up on one end of the frame or the tabs may break.
- Remove Inner Frame and set aside. (**Remember to identify the opposite end of the Outer Frame. Those ends will be switched to the same side in Step 4 for final assembly.** (see Fig. C and Fig. 4-A.)
- Inspect Outer Frame to ensure all Clips are in the vertical (straight up and down) position.

## 3. PLACE DOOR OVER OUTER FRAME AND GLASS (OUTSIDE FRAME GOES OUTSIDE YOUR HOME-IT HAS CLIPS)

- Position the Outer Frame and Glass on the table/flat surface area.
- Make sure the outside of the door is face down, the inside is face up. (see Fig. 3-A)
- Align door over the Outer Frame and Glass and carefully lower the door's glass opening/cutout area so the Outer Frame is under the door with metal clips inside the door's cutout area. Make sure the outside of the door is face down, the inside is face up. (see Fig. 3-A and Fig. 3-B.)
  - Important: Do not drop the door on the frame clips as this may damage the Clips or Tabs.
- Doorglass and Outer Frame assembly should be positioned so that the frame is aligned with the bottom of the door cutout. (see Fig 3-B.) and seated properly.
- Ensure the door cutout is in contact with the Resolve (foam) Sealant, pressed tight to the Outer Frame (see Fig. 3-C.)

Fig.3-C

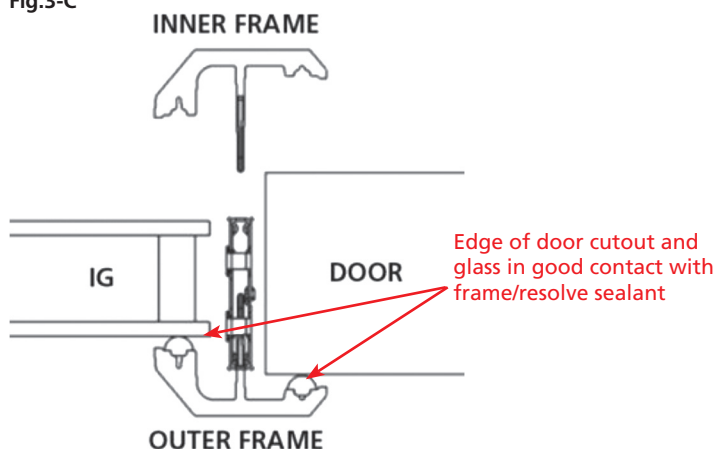



Fig.4-A

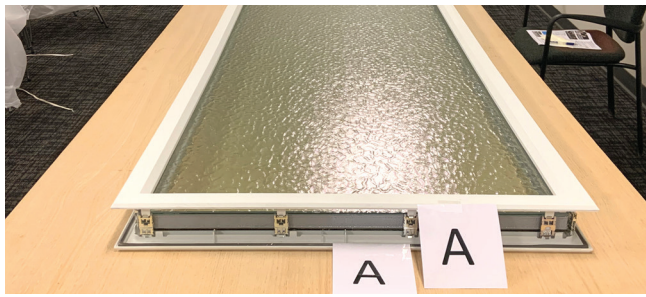

Fig.4-B

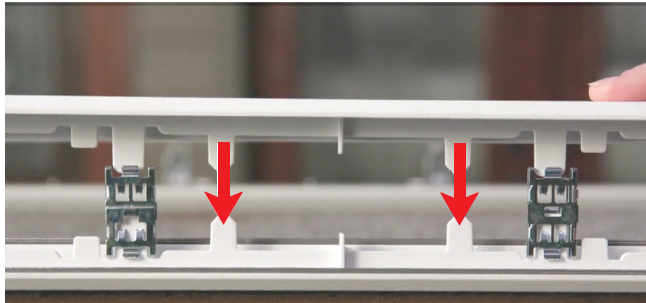

Fig.4-C

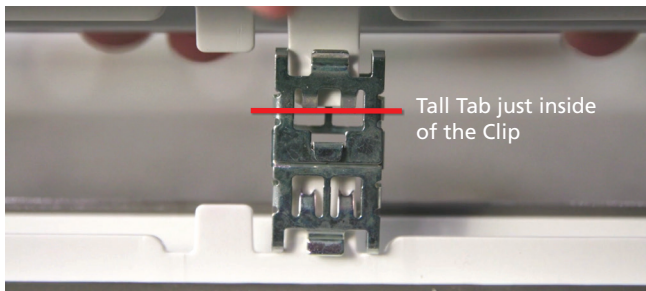
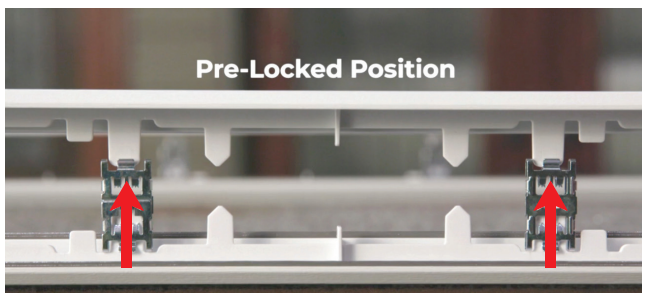

Fig.5-A



Fig.5-B



#### 4. PREPARE TO INSTALL THE INNER FRAME

- Make sure the Inner Frame is in the opposite direction (180°) from shipping position. If you placed a note at one end of the Inner Frame and one at the opposite end of the Outer Frame when you started, the notes should now be positioned on the same end of frames. (see Fig. 4-A.)
- To ensure the Outer and Inner Frames are aligned and ready for assembly, match up the four sets of alignment arrows along the vertical section of the Inner and Outer Frames. This should ensure the critical alignment of the Tall Tabs with the Clips. (see Fig. 4-B.)

- To do this start in one corner and align the Tall Tabs with the Clips. (see Fig. D). Proceed down the long side of the frame, aligning the Tall Tabs to the Clips until you reach the opposite corner. The remainder of the frame can be laid down and the Tall Tabs and Clips should be aligned.
- **IMPORTANT:** Visually inspect along the glass edge that each Tall Tab is inside the top edge of the Clip, but do not engage or lock into the Clip. (see Fig. 4-C.) Once Tall Tabs are fully pressed into Clips they are permanently locked and cannot be pulled apart.

#### 5. INSTALL INNER FRAME

*(INSIDE FRAME GOES INSIDE YOUR HOME)*

- Gently work your way around the frame, pressing the Tall Tabs partway into the Clips to the pre-locked position. (see Fig. 5-A & 5-B).
- Pre-Locked Position: Initially you will feel a friction fit to the Clip. In the next step you will insert each Tall Tab further to lock them into place. Only do this after you are sure each Tall Tab is aligned and friction fitted with the appropriate Clip.
- Once the Tall Tabs and Clips are all aligned and friction fitted, press the door down with one hand to ensure the Outer Frame is tight to the door and the frame's Resolve (foam) Sealant is compressed. Use a rubber mallet around the Inner Frame to lightly tap the Tall Tabs all the way into the Clips as you work your way around the Inner Frame (see Fig. 5-C.) This process will lock the Tall Tabs into the Clips

**IMPORTANT:** Be gentle and take your time. You should go around the frame a few times with increasing force to the door, to lock the Tall Tabs into the Clips.

Fig.5-C



Fig.6-A

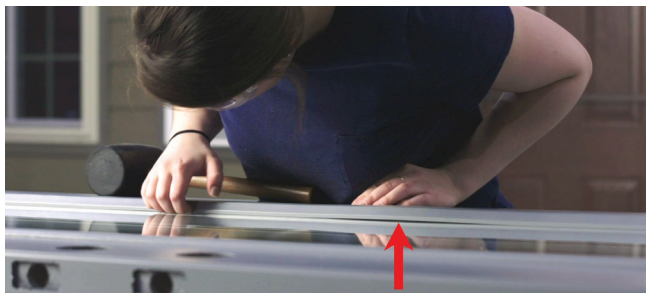

Fig.6-B

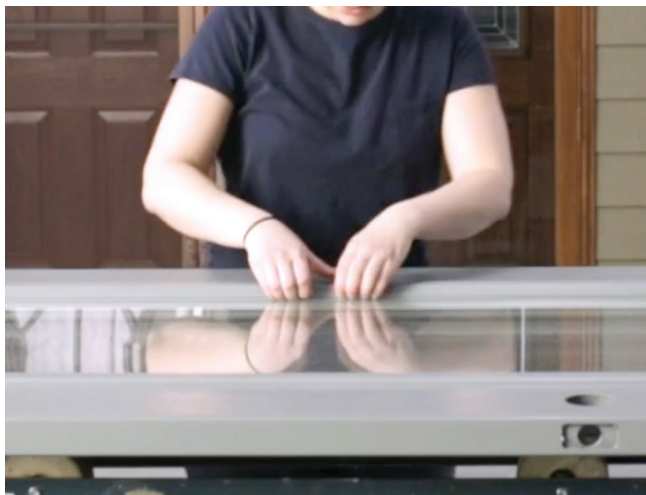

Fig.6-C

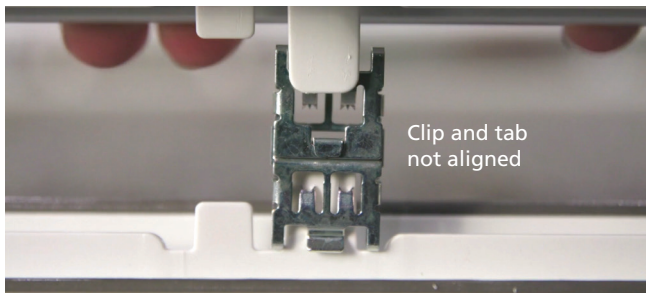
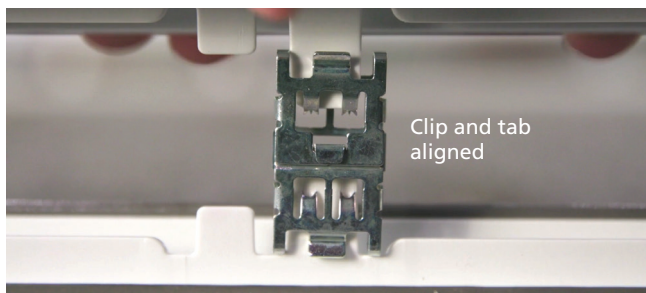

Fig.6-D



## 6. INSPECT INNER FRAME FOR GAP

- Inspect perimeter of Inner Frame to glass, and Inner Frame to door, for any gaps. (see Fig. 6-A)
- If gaps are present, repeat step 5.
- If repeating step 5 is not successful and a gap is still present, a Clip was likely missed. Carefully lift Inner Frame at gap location (see Fig. 6-B) and attempt to align Tall Tab into Clip (see clip alignment incorrect Fig. 6-C and correct Fig. 6-D)
  - This can be done but it is difficult. A pry bar may be needed to gently lift frame – if required see Appendix #1 for guidance. Then repeat step 5. If a gap cannot be eliminated and the frame has movement away from door by hand, the frame will need to be completely removed and replaced. (Please call our customer service at 1-866-635-4968 for assistance and to order a new frame.)

## 7. INSPECT OUTER FRAME FOR GAP

- Flip door over so the Outer Frame is up and inspect perimeter of Outer Frame to glass, and Outer Frame to door, for any gaps (See Fig. 6-A).
- If gaps are present repeat step 5.
- If repeating step 5 is not successful and a gap is still present, a Clip was likely missed. Carefully lift Outer Frame at gap location (See Fig. 6-B) and attempt to align Tall Tab into Clip (see clip alignment incorrect Fig. 6-C and correct Fig. 6-D.)
  - This can be done but it is difficult. A pry bar may be needed to gently lift frame – if required see Appendix #1 for guidance. Then repeat step 5. If a gap cannot be eliminated and the frame has movement away from door by hand, the frame will need to be completely removed and replaced. (Please call our customer service at 1-866-635-4968 for assistance and to order a new frame)

Please go to

[zeel.odl.com/install](https://zeel.odl.com/install)

to view installation video



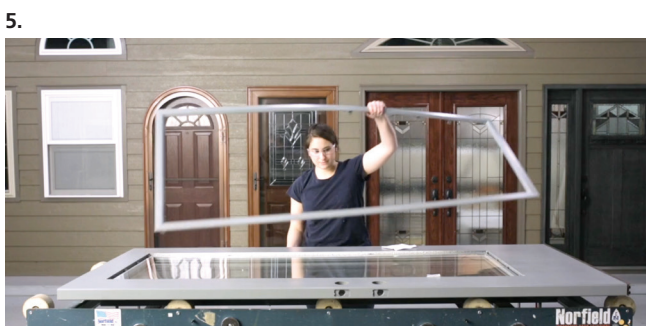
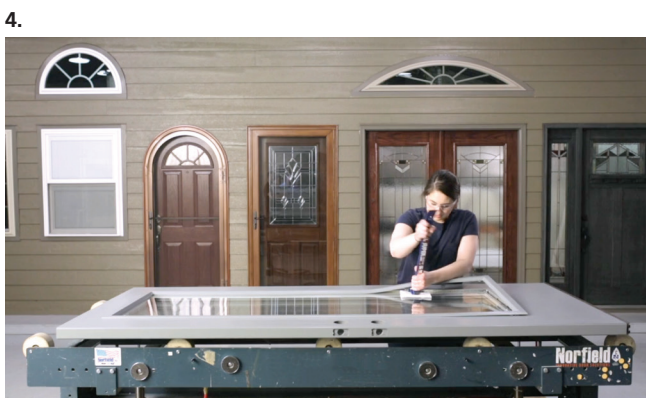

# Appendix 1:

## ZEEL® FRAME UNINSTALL INSTRUCTIONS

### 1. GETTING STARTED

Tools needed: pry bar, hammer, soft cloth, and safety glasses.

Place door with glass frame on a table, or other flat, solid and stable surface, that is larger than the assembly.

### 2. POSITION THE PRY BAR

To start, use the flat chamfered end of the pry bar.

*Tip: Place a soft cloth under the pry bar to prevent scratching the glass.*

### 3. WEDGE PRY BAR BETWEEN FRAME AND GLASS

Pry bar may need to be gently tapped with hammer to get under frame.

### 4. PUSH DOWN ON PRY BAR TO LIFT UP FRAME

Push down on the pry bar to break apart the tabs holding the frame together.

*Tip: The easiest way to locate a tab is to begin in a corner. Work slowly around the perimeter of the frame.*

Break apart every tab one by one.

*Tip: Move cloth around perimeter as you go to avoid damaging the glass.*

### 5. REMOVE FRAME

Uninstall is now complete. Frame cannot be re-used.

# FINISHING INSTRUCTIONS

This frame is designed to be painted and/or stained. Use the same high quality exterior grade paint or stain as used to finish the entry door.

## Frame Surface Prep

The frame should be free of any dust and debris. Use mild detergent and water. The frame should be dry and acclimated to room temperature before applying paint. No other surface prep is necessary for finishing this frame.

NOTE: DO NOT APPLY ADHESION PROMOTERS or PRIMERS containing adhesion promoter to this frame.

## Painting & Staining

**Painting:** Recommended for use with exterior latex paint. Apply thin coats, allowing paint to dry between coats, achieve the desired coverage and finish.

**Staining:** A 2-Step Staining process is recommended for the most desirable level of adhesion.

**Step 1** - apply an opaque base coat of paint to the frame, as described above.

**Step 2** - apply the stain to the frame. Work stain into the graining with a sponge or cloth.

Wipe off the excess stain for the desired finish. Stain manufacturers instructions may differ or provide additional information. Please follow their instructions. Apply a compatible clear top coat to the manufacturers recommendation to protect finish.

# WARRANTY INFORMATION

## ODL Doorglass Warranty Information

ODL Doorglass is covered by a limited 20 year warranty. Labor is not included in the warranty. The warranty does not apply to damage from shipping, handling, installation, storage, environmental conditions, or unusual service conditions or usage.

For warranty information contact:

ODL Customer Service, 215 East Roosevelt Ave., Zeeland, MI 49464.

[www.odl.com](http://www.odl.com)

1.800.253.3900



215 East Roosevelt Ave., Zeeland, MI 49464  
800.253.3900 [www.odl.com](http://www.odl.com)