



**PIONEER INDUSTRIES, INC.**  
 3325 S. Garfield Ave.  
 Commerce, CA 90040  
 (800) 338-9468  
 www.pioneerind.com

# INSTALLATION

**Tools:**



Adjustable Wrench



Plumbers Putty



Teflon Tape



Rags

**Model Number: 3BR3X0**



**Warnings and Notes:**

Check with local plumbing code requirements before installation.  
 This product should be installed by a local listed plumber.  
**Do not use plumbers putty on threads.**

**Installation Steps:**

Two Handle Lavatory Faucet

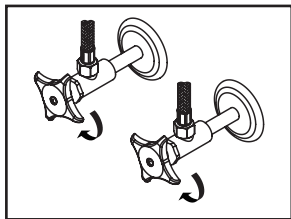

(1) Shut off water supplies. Remove old faucet. Clean mounting surface in preparation for new faucet.

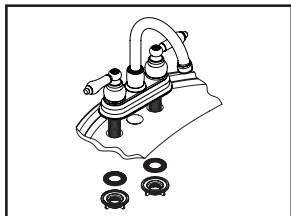

(2) Apply plumbers putty under the base gasket. Place the faucet in position on the sink. Install washer on shanks and tighten with locknut.

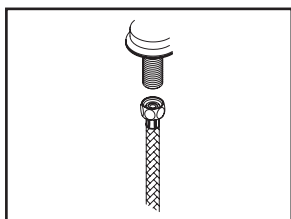

(3) when using stainless steel braided faucet supply hose; this faucet requires one end of the supply hose to have a 1/2" female IPS connection. The other end of this supply hose must match the thread on the water supply valve under your sink. Once you've identified the required size, carefully follow the manufacturer's installation instructions for each hose.

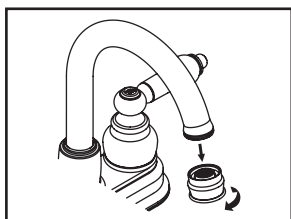

(4) Important: After installation is complete, remove aerator. Turn water supplies on and allow both hot and cold water to run at least one minute each. While water is running, check for leaks. Turn off water and replace aerator.

**Pop-up Drain Installation:**

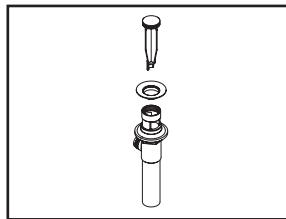

(1) Remove pop-up flange from body

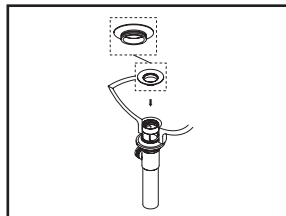

(2) Place a ring of plumbers putty on the bottom of flange.

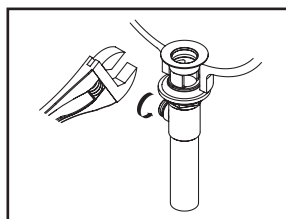

(3) Insert pop-up flange through drain hole and attach flange to body. Use Teflon tape to thread tail piece to Pop-up drain body. Ensure the pop-up outlet faces towards the back of the sink. Tighten the locknut securely with a wrench. Do not overtighten.

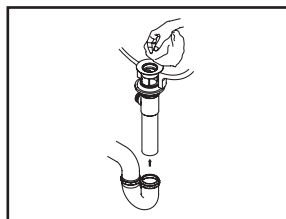

(4) Remove the excess plumbers putty. Connect the trap (check manufacturer's instructions for installation).

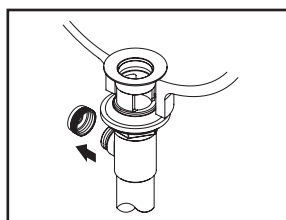

(5) Remove pivot rod nut from pop-up body, ensure the washers is in place, insert pivot rod, tighten pivot rod nut back to pop-up body.

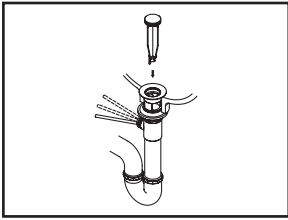

(6) Push pivot rod down, insert drain plug carefully. Test to ensure drain plug works properly.

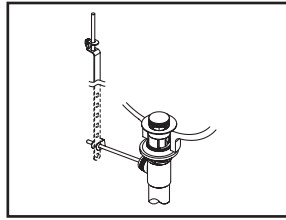

(7) Connect lift rod strap to pivot rod by using clip. Tighten the thumbscrew to connect lift rod strap to pop-up lift rod.

## Exploded Drawing :

\* Note: Please specify finish/color when ordering.

	ITEM #	DESCRIPTION
A	X-1900009C, H*	Lever Handle-C, H (For 3BR300)
A	X-1900010C, H*	Porcelain Lever Handle-C, H (For 3BR310)
B	X-4900037	Bonnet Nut
C	X-4900038	Gasket
D	X-3900002C, H	Ceramic Stem-Cold,Hot
E	X-4300018	Base Gasket
F	X-4900008	Mounting Kit
G	X-4900004	Supply Nuts
H	X-4900124*	1.2 GPM Aerator
I	X-6300007*	Brass Pop-Up Drain Assembly
1	X-4900042C, H*	Button-C, H
2	X-4900061	Handle Screw
5	X-4200090	Spout Snap Ring
6	X-4900012	Spout O-Rings

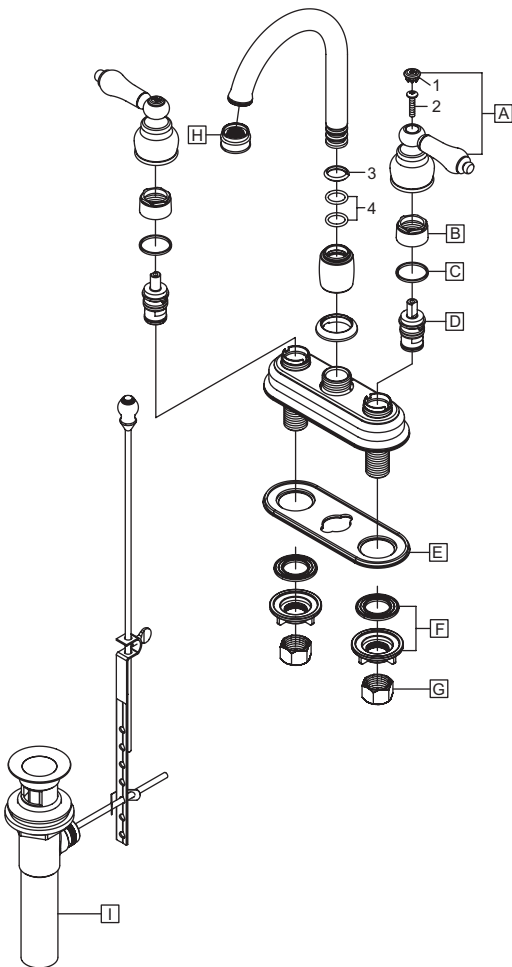

For more care information or trouble shooting inquiries about your Pioneer product, please call:  
**Pioneer Industries, Inc.** (800) 338-9468  
 Monday-Friday 8 AM to 8 PM EST (5 AM to 5 PM PST)  
[www.pioneerind.com](http://www.pioneerind.com)