

# ASSEMBLY INSTRUCTION

**SKU:N763P326441**

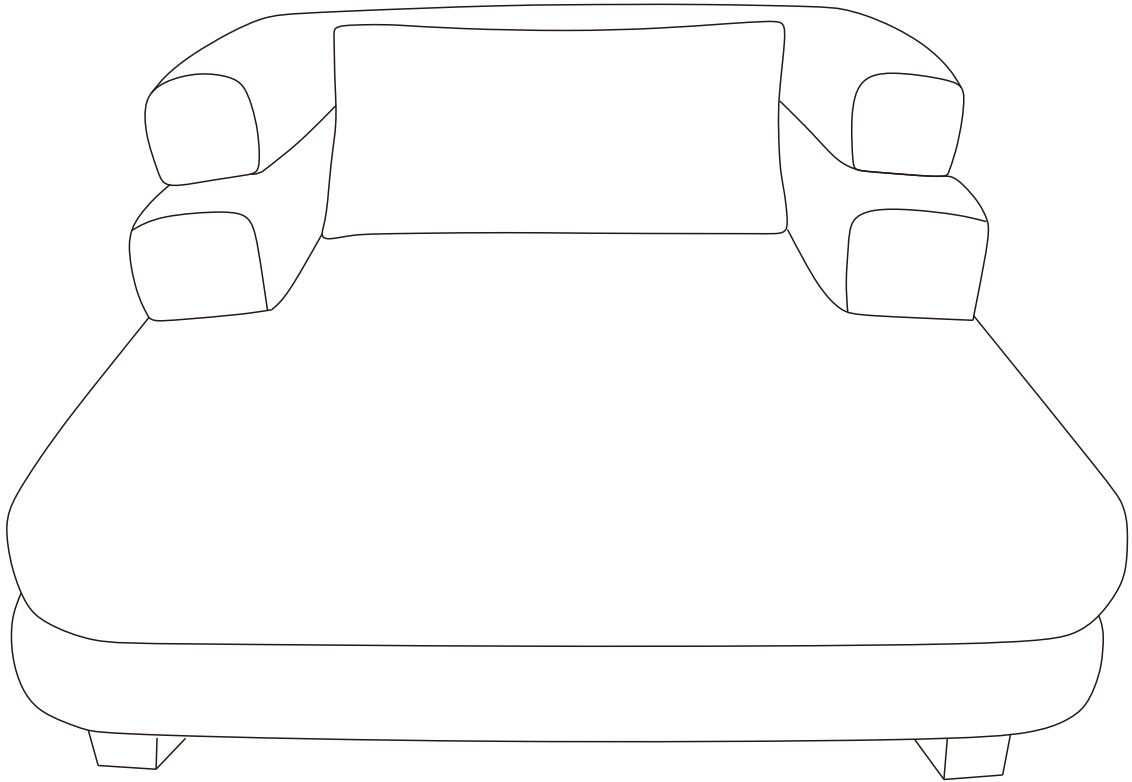

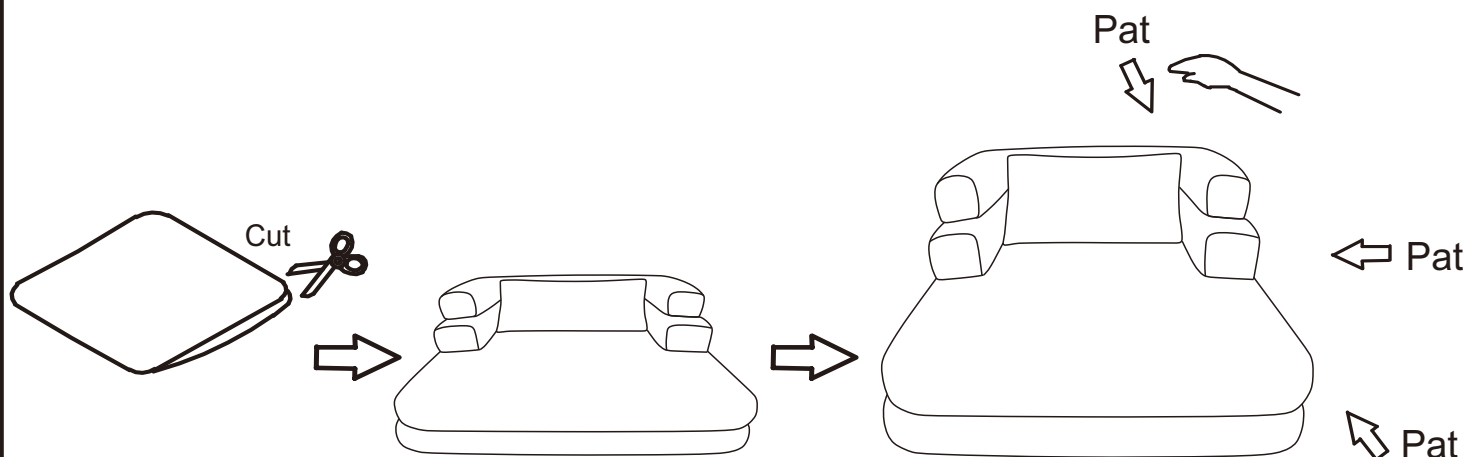

After unpacking, place the sofa in a dry, well-ventilated area. It will fully regain its shape and comfort within approximately 72 hours.

Slight fabric wrinkles are normal due to prolonged vacuum compression during shipping. To remove them:

- Gently shake and fluff the sofa.
- Use an iron or steamer to remove wrinkles.

A X1

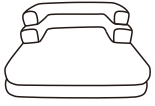

B X1



C X1



D X2



E X8

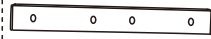

F X9



G X9



H X1



I X32



M6\*35

J X32

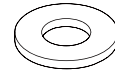

C X1

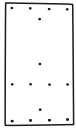

D X1



H X1



I X16



J X16



01

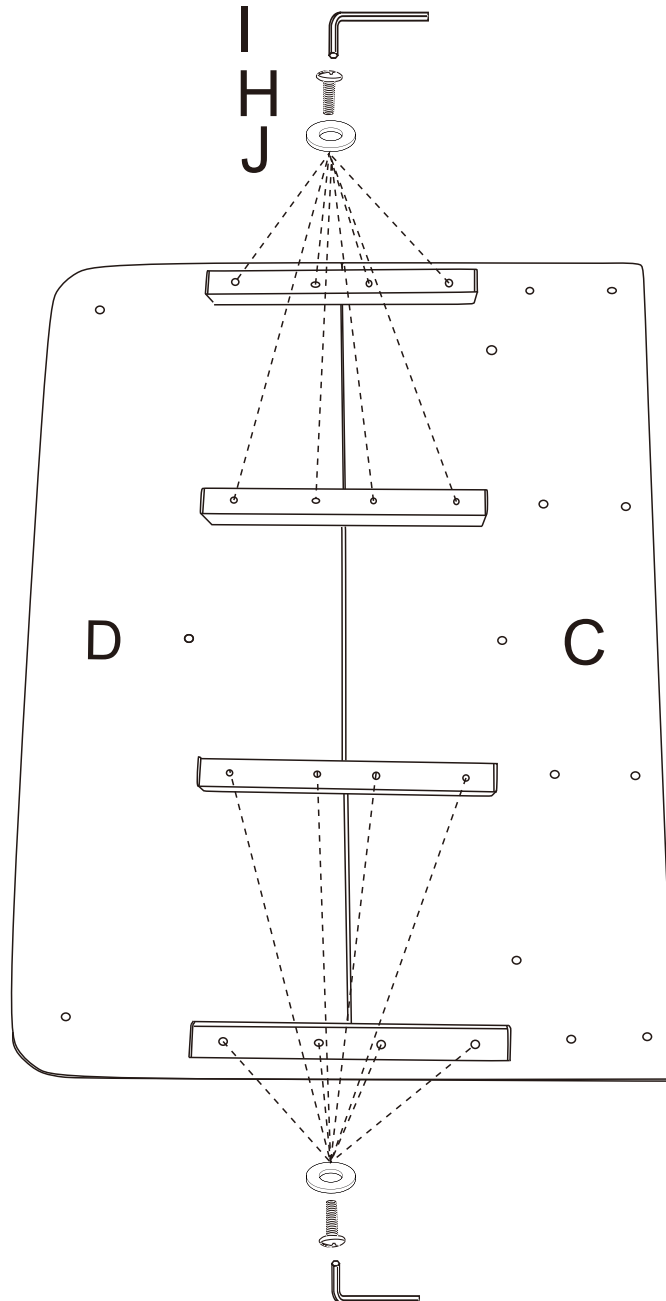

**D** X1

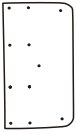

**H** X1



**I** X16



**J** X16

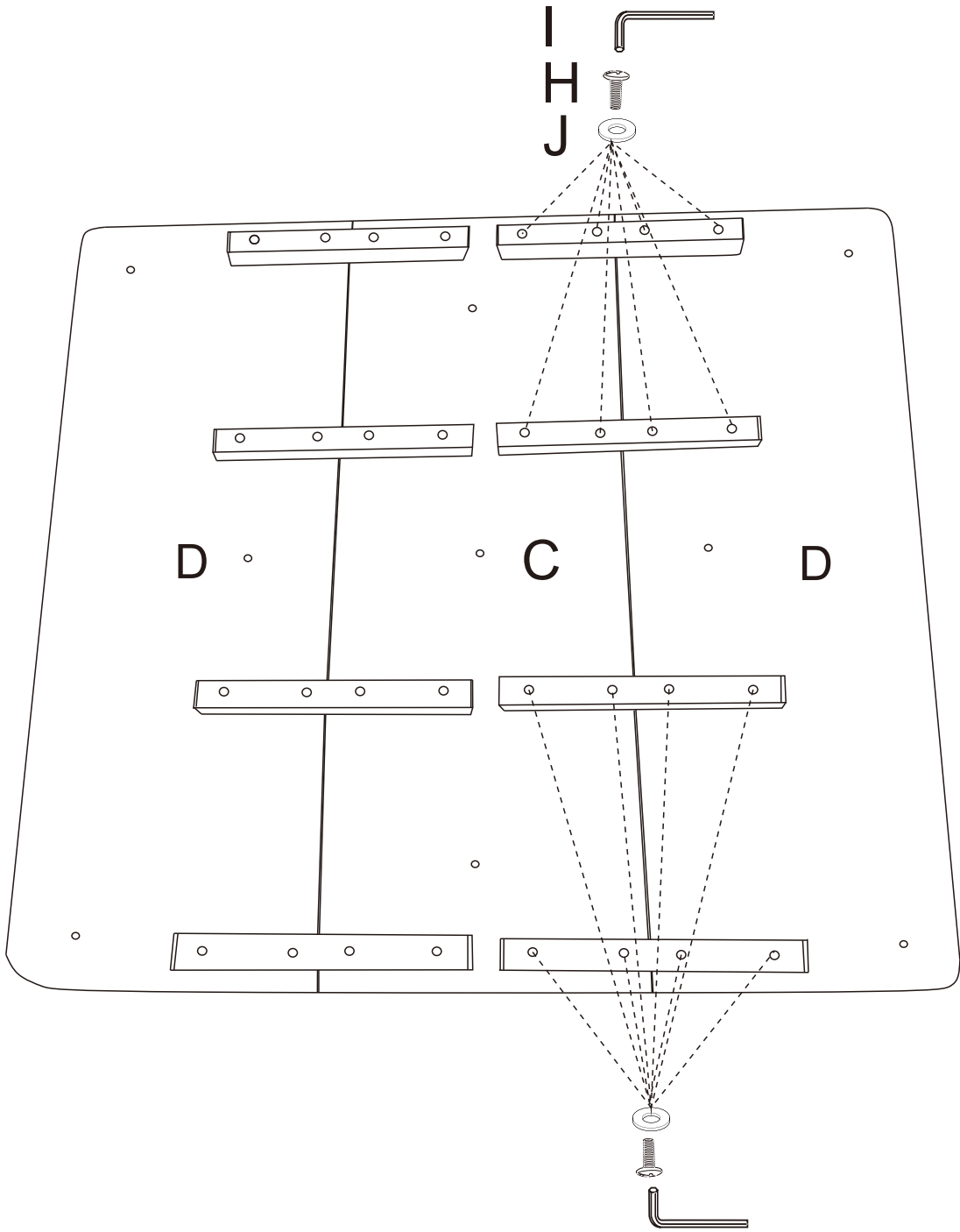

**F**X9



**G**X9

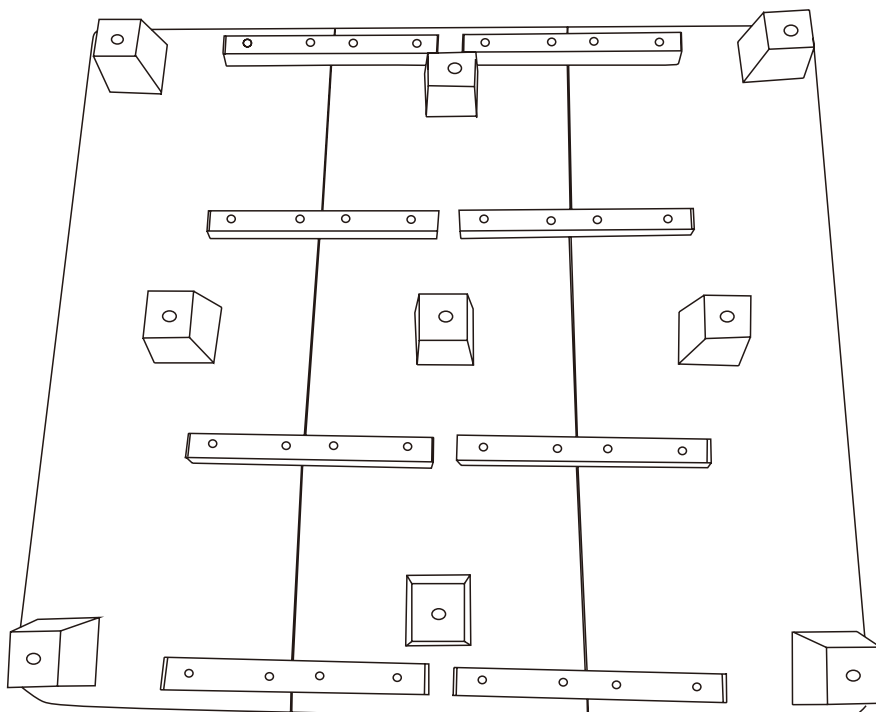
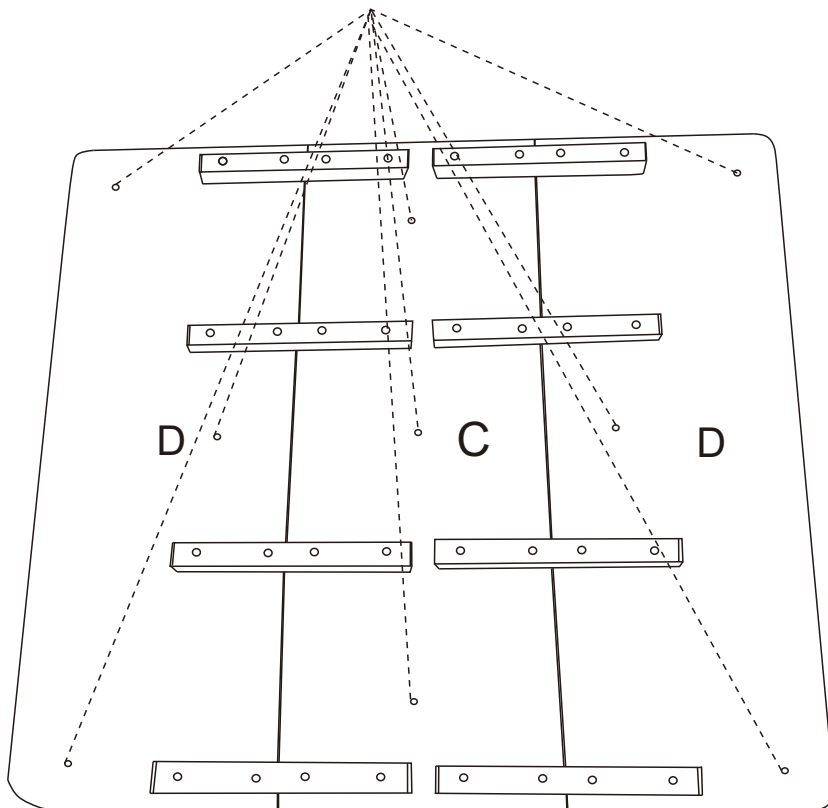

A X1

04

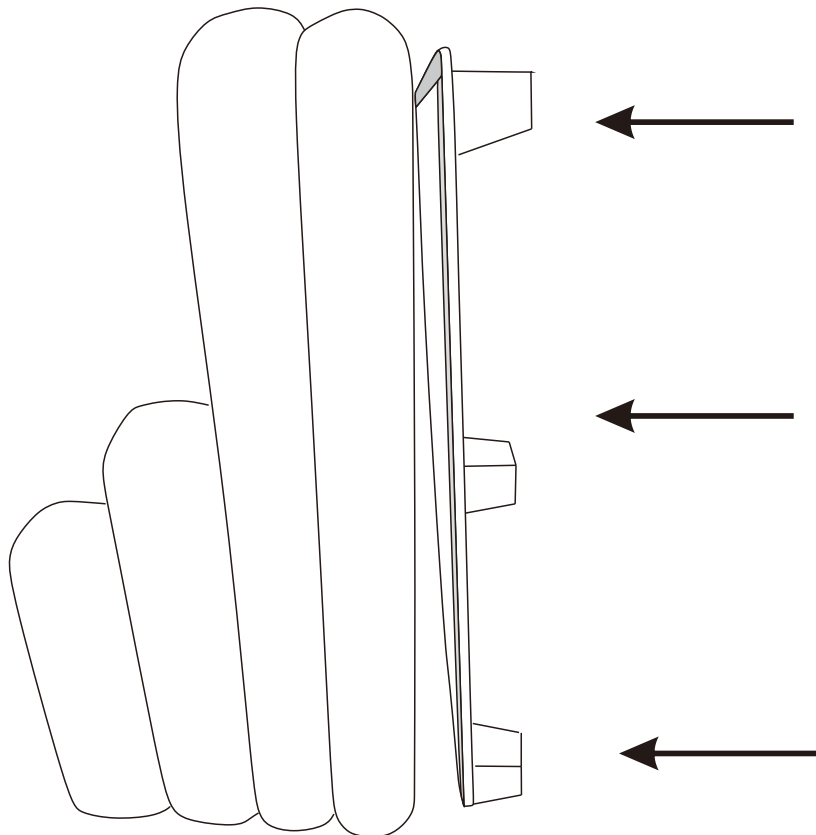
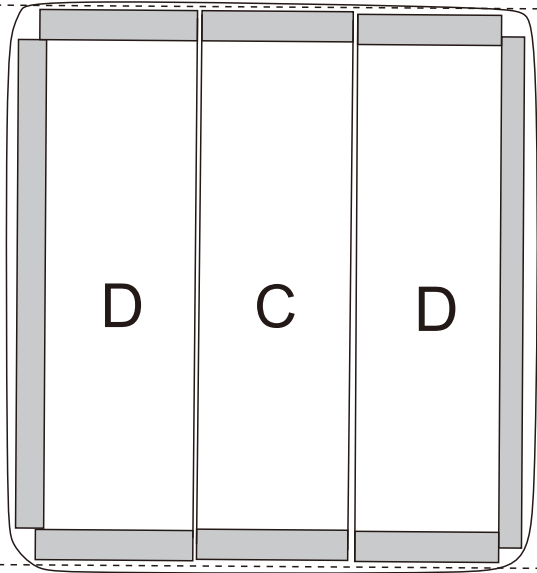
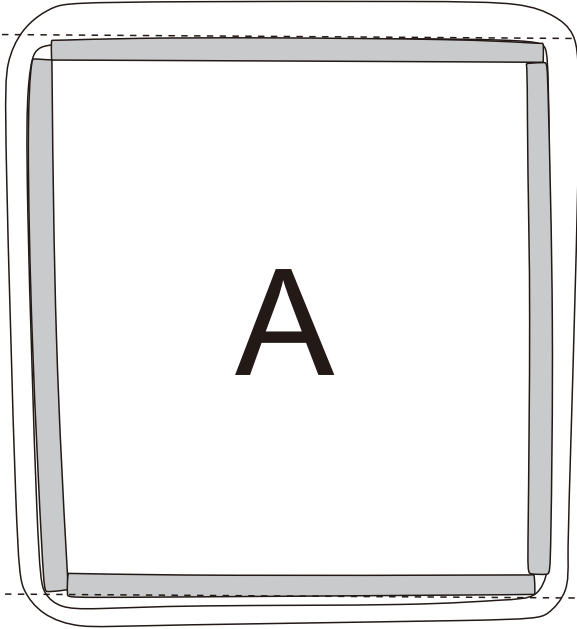
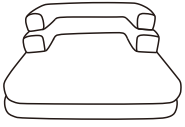

**B** X1



**Done**

