

### Robe Hook (03)

1. Locate where Robe Hook should be installed
2. Mark holes by using mounting plate as template
3. Drill 1/4" holes in wall and install plastic anchors flush with finished wall
4. Place mounting plate on wall and secure with screws provided
5. Place Robe Hook on the Rosette style you have chosen by inserting square on bottom of Robe Hook into square in center of Rosette
6. Slide both Rosette and Robe Hook onto mounting plate. You may need to loosen the installed set screw with the allen wrench provided.
7. Press the Robe Hook firmly to the wall and tighten set screw with the allen wrench provided.

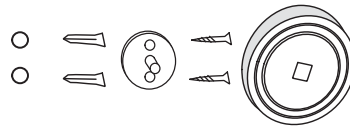

### Euro Tissue(07)

1. Locate where Euro Tissue should be installed
2. Mark holes by using mounting plate as template
3. Drill 1/4" holes in wall and install plastic anchors flush with finished wall
4. Place mounting plate on wall and secure with screws provided
5. Place Euro Tissue assembly on the Rosette style you have chosen by inserting square on bottom of Euro Tissue into square in center of Rosette
6. Slide both Rosette and Euro Tissue assembly onto mounting plate. You may need to loosen the installed set screw with the allen wrench provided.
7. Press the Euro Tissue firmly to the wall and tighten set screw with the allen wrench provided.

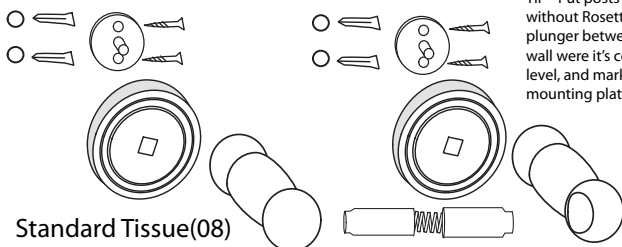
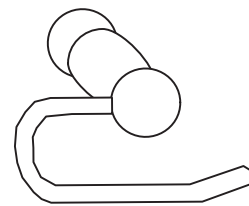

### Standard Tissue(08)

1. Locate where Standard Tissue should be installed
2. Mark holes by using mounting plate as template
3. Drill 1/4" holes in wall and install plastic anchors flush with finished wall
4. Place mounting plate on wall and secure with screws provided
5. Place Standard Tissue assembly on the Rosette style you have chosen by inserting square on bottom of Standard Tissue into square in center of Rosette
6. Slide both Rosette and Standard Tissue assembly onto mounting plate. You may need to loosen the installed set screw with the allen wrench provided.
7. Press the Standard Tissue firmly to the wall and tightenset screw with the allen wrench provided.

TIP - Put posts on mounting plates without Rosettes and insert the plunger between them. Locate on wall were it's comfortable to you, level, and mark the holes in the mounting plates

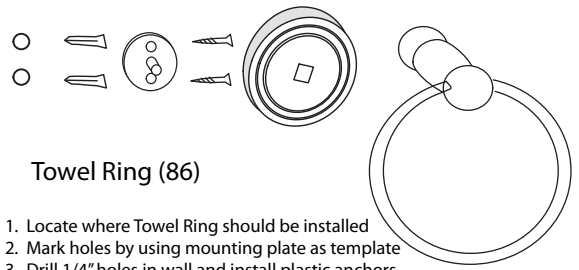

### Towel Ring (86)

1. Locate where Towel Ring should be installed
2. Mark holes by using mounting plate as template
3. Drill 1/4" holes in wall and install plastic anchors flush with finished wall
4. Place mounting plate on wall and secure with screws provided
5. Place Towel Ring on the Rosette style you have chosen by inserting square on bottom of Towel Ring into square in center of Rosette
6. Slide both Rosette and Towel Ring onto mounting plate. You may need to loosen the installed set screw with the allen wrench provided.
7. Press the Towel Ring firmly to the wall and tighten set screw with the allen wrench provided.

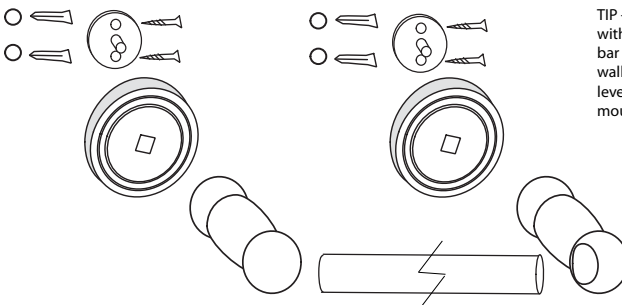

### 18" Towel Bar (18) 24" Towel Bar (24)

TIP - Put posts on mounting plates without Rosettes and insert the bar between them. Locate on wall were it's comfortable to you, level, and mark the holes in the mounting plates

1. Locate where Towel Bar should be installed
2. Mark holes by using mounting plate as template
3. Drill 1/4" holes in wall and install plastic anchors flush with finished wall
4. Place mounting plate on wall and secure with screws provided
5. Place Towel Bar assembly on the Rosette style you have chosen. Insert square on bottom of Towel Bar into square in center of Rosette
6. Slide both Rosette and Towel Bar assembly onto mounting plate. You may need to loosen the installed set screw with the allen wrench provided.
7. Press the Towel Bar firmly to the wall and tighten set screw with the allen wrench provided.

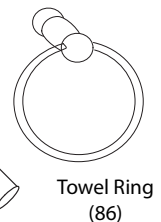
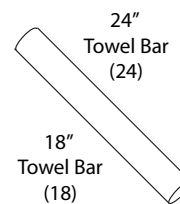
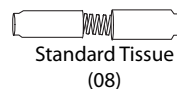
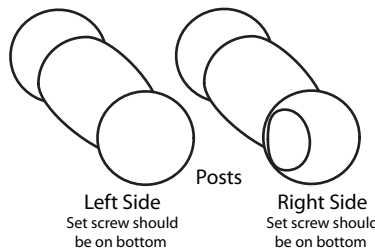

## Contents of Bathroom Fixtures

| Robe Hook (03)         | Euro Tissue (07)                       | Standard Tissue (08)         | 18" or 24" Towel Bar (18 or 24)   | Towel Ring (86)                        |
|------------------------|--|------------------------------|-----------------------------------|--|
| 1 - Mounting Plate     | 1 - Mounting Plate                     | 2 - Mounting Plate           | 2 - Mounting Plate                | 1 - Mounting Plate                     |
| 2 - Plastic Anchor     | 2 - Plastic Anchor                     | 4 - Plastic Anchor           | 4 - Plastic Anchor                | 2 - Plastic Anchor                     |
| 2 - Mounting Screws    | 2 - Mounting Screws                    | 4 - Mounting Screws          | 4 - Mounting Screws               | 2 - Mounting Screws                    |
| 1 - Rosette            | 1 - Rosette                            | 2 - Rosette                  | 2 - Rosette                       | 1 - Rosette                            |
| 1 - Hook with Setscrew | 1 - Assembled Tissue arm with Setscrew | 2 - Posts (1 left & 1 Right) | 2 - Posts (1 left & 1 Right)      | 1 - Assembled Towel Ring with Setscrew |
|                        |  | 1 - Plunger assembly         | 1 - Towel Bar (Either 18" or 24") |  |